

novantadieci®

# INDICE GENERALE

General Index / Allgemeiner Index / Indice général

<b>Azienda</b> <i>Company Unternehmen Entreprise</i>	<b>4</b>	<b>Incasso a parete</b> <i>Wall recessed lighting Wand-Einbauleuchten Encastrés muraux</i>	<b>18</b>	<b>Segnapassi</b> <i>Pathmarkers Orientierungsbeleuchtung Balisages encastrés</i>	<b>295</b>	<b>Parti elettriche</b> <i>Electrical parts Elektrische Teile Parties électriques</i>	<b>400</b>
<b>Materiali e finiture</b> <i>Materials and finishes Materialien und Ausführungen Matériaux et finitions</i>	<b>8</b>	<b>A parete</b> <i>Wall lighting Wandleuchten Appliques</i>	<b>56</b>	<b>Profili</b> <i>Profiles Profile Profils</i>	<b>320</b>	<b>Sistemi di installazione</b> <i>Installation systems Installationssysteme Systèmes d'installation</i>	<b>418</b>
<b>Esempio Lettura Pagina Catalogo</b> <i>Example catalogue page Angaben für das Lesen der Katalogseite Informations pour lire la page du catalogue</i>	<b>16</b>	<b>Incasso a plafone</b> <i>Ceiling recessed lighting Decken-Einbauleuchten Encastrés plafonds</i>	<b>158</b>	<b>Sistema audio SONORE®</b> <i>SONORE® audio system SONORE®-Audiosystem Système audio SONORE®</i>	<b>356</b>	<b>Indice analitico</b> <i>Analytical Index Analytischer Index Index analytique</i>	<b>430</b>
		<b>A plafone</b> <i>Ceiling lighting Deckenleuchten Plafonniers</i>	<b>218</b>	<b>Sospensioni</b> <i>Hanging lamps Pendelleuchten Suspensions</i>	<b>370</b>		
		<b>Incasso a plafone e a parete</b> <i>Ceiling and wall recessed lighting Wand- und Decken-Einbauleuchten Encastrés muraux et plafonds</i>	<b>244</b>	<b>Lampade da tavolo</b> <i>Table lamps Tischleuchten Lampes de table</i>	<b>382</b>		
		<b>A plafone e a parete</b> <i>Ceiling and wall lighting Decken- und Wandleuchten Plafonniers et appliques</i>	<b>278</b>	<b>Esterno</b> <i>Outdoor Lamps Aussenleuchten Lampes d'extérieur</i>	<b>388</b>		
		<b>Incasso 15 mm</b> <i>15mm recessed lighting 15 mm Einbauleuchten Encastrés 15 mm</i>	<b>286</b>	<b>Lampadine e strip LED</b> <i>Strip LED and bulbs LED Bänder und Leuchtmittel Ruban LED et ampoules</i>	<b>394</b>		

# Da 50 anni diamo forma alla luce

We give a shape to light since 50 years



Belfiore nasce nel 1968 a Nove, nel cuore del Veneto. L'esordio è nella produzione di ceramiche artigianali, in una zona ricca di materie prime e di una tradizione manifatturiera. Negli anni ottanta entra nel mondo dell'illuminazione con le prime applique in ceramica. Nel 2011 nasce 9010, che entra d'impeto nel mercato dell'illuminazione da incasso, imponendosi per filosofia innovativa, completezza di gamma e soluzioni contemporanee supportate da numerosi brevetti.

**EN** Belfiore was originally founded in 1968 in Nove, in the heart of Veneto. Its beginnings see the production of hand-made ceramics in an area rich in raw materials and ceramic manufacturing. In the eighties the company enters the lighting world with the first models of ceramic wall lamps. In 2011 BELFIORE created 9010, which brings together its experience and dynamism. 9010 enters with impetus the market of down lighting, imposing itself for the innovative philosophy and a wide and complete product range supported by several patents.

**DE** Belfiore wurde im Jahre 1968 in Venetien gegründet, in einer Gegend, die reich an Rohstoffen ist und in der handgemachte Keramik Tradition hat. Die Anfänge der Herstellung von Keramikwandleuchten für die Beleuchtungsindustrie liegen in den Achtzigerjahren. Im Jahr 2011 präsentiert BELFIORE schließlich die Kollektion 9010. Die Einführung dieser neuen Produkte ist letztlich auf eine rasante Entwicklung des Unternehmens zurückzuführen. Die Kollektion 9010 wird schließlich zum Vorreiter für den Beleuchtungsmarkt, speziell im Bereich Einbauleuchten. Sie überzeugt durch patentierte innovative Produkte und ein breitgefächertes Sortiment und bietet dem Planer eine Vielzahl an Gestaltungsmöglichkeiten.

**FR** Belfiore a été fondée en 1968 à Nove, au cœur de la Région Venitienne. Ses débuts ont été dans la production de céramiques artisanales, fabriquée à la main dans une région riche en matières premières et dans le respect de l'art et la tradition de fabrication. Dans les années quatre-vingt, la société entre dans le monde de l'éclairage avec les premiers modèles d'applique en céramique. En 2011 BELFIORE crée la collection 9010 qui en saisit pleinement l'expérience et le dynamisme. 9010 entre avec impétuosité sur le marché du luminaire encastrable, en s'imposant de par sa philosophie innovante, l'exhaustivité de sa gamme et les solutions modernes et contemporaines qu'elle propose et qui sont supportées par de très nombreux brevets.

1968 50 2018

**EN** It feels like we started yesterday because our enthusiasm and dynamism are the same, but a lot of things have happened. We started small, we expanded, we have understood the changing of times, and have done everything to respond to your needs. We have listened to your opinions, turning them into services that have made us unique and different. The new generations have joined the old, and we have launched new strategies and integrated tools for contemporary communication to offer you something more. We have dealt with our territory and environmental heritage with projects to support the Bassano Bridge, the Territories of the Brenta and the Asiago plateau. We decided to focus on 9010. We are the same, but just more structured, efficient, dynamic, modern, and experienced. And it's been just 50 years!

**DE** Es scheint, als ob wir erst gestern begonnen hätten, denn unsere Begeisterung und Dynamik sind unverändert. Und doch hat sich inzwischen sehr viel ereignet. Am Anfang waren wir nur einige wenige Mitarbeiter. Mit der Zeit haben wir uns vergrößert und es ist uns gelungen, mit den Veränderungen Schritt zu halten. Um Ihren Anforderungen gerecht zu werden, ist uns Ihre Meinung daher sehr wichtig. Denn wir wollen uns kontinuierlich verbessern und unsere herausragende Stellung im Markt behaupten. Neue Strategien und moderne Kommunikationsmittel sind entstanden, um Ihnen noch mehr zu anbieten. Zum Schutz der Umwelt wirken wir zudem bei mehreren Projekten mit. Mit unserem Engagement unterstützen wir dabei u.a. den Erhalt der Brücke von Bassano, des Brenta-Territoriums und der Hochebene von Asiago. Wir setzen in Zukunft verstärkt auf 9010, denn wir sind jetzt noch effizienter, dynamischer und moderner. Es sind gerade mal 50 Jahre vergangen!

**FR** - Il nous semble avoir commencé hier, car notre enthousiasme et notre dynamisme sont restés les mêmes, mais il s'est passé beaucoup de choses : nous sommes partis peu nombreux au démarrage, nous nous sommes agrandis, nous avons compris les changements caractéristiques de notre époque et nous avons fait de notre mieux pour répondre à vos exigences. Nous avons écouté vos avis et les avons transformés en services, qui nous ont rendus uniques et différents. Les nouvelles générations se sont associées à celles qui les ont précédées, ont mis en œuvre de nouvelles stratégies et intégré des outils de communication modernes pour vous offrir toujours davantage. Nous nous sommes occupés de notre territoire et du patrimoine environnemental avec des projets de soutien pour le Pont de Bassano, les Territoires de Brenta et le plateau Asiago. Nous avons décidé de miser sur 9010, mais nous sommes restés les mêmes : plus structurés, plus efficaces, plus dynamiques, plus modernes et plus préparés. Et tout ça en 50 ans seulement!

Ci sembra di aver iniziato ieri, perché il nostro entusiasmo e la nostra dinamicità sono gli stessi, ma di cose ne sono successe davvero tante: siamo partiti in pochi, ci siamo ingranditi, abbiamo compreso i mutamenti dei tempi e fatto di tutto per rispondere alle vostre esigenze.

Abbiamo ascoltato i vostri pareri creando servizi che ci hanno resi unici e diversi. Le nuove generazioni hanno affiancato le vecchie, avviato nuove strategie e integrato strumenti di comunicazione contemporanea per offrirvi sempre qualcosa in più.

Ci siamo occupati del nostro territorio e del patrimonio ambientale con progetti di sostegno al Ponte di Bassano, ai Territori del Brenta e all'Altopiano di Asiago. Abbiamo deciso di puntare su 9010, ma siamo sempre noi, più strutturati, più efficienti, più dinamici, più moderni e più preparati.

E sono passati appena 50 anni!



# Identità

Situata in una regione ricca di tesori e attività artistiche, Nove possiede una secolare tradizione di artigianato che le dona la nomea mondiale di Città della Ceramica. Una storia che nasce dal territorio veneto: dall'Altopiano di Asiago veniva ricavato il gesso, dalle colline di Marostica l'argilla, e dai Tretto il caolino. Una realtà estesissima che, a Nove come nel resto del Veneto, ha contribuito ad accrescere la fama del Made in Italy con antiche ed illustri manifatture di grande qualità. Un percorso cresciuto sempre più nel tempo, sino a giungere a 9010, leader nella produzione dell'illuminazione di design e prestigio, affermata sul panorama internazionale.



Il Marchio d'Area TERRITORI DEL BRENTA rappresenta in modo univoco non tanto e solo l'area geografica della valle, le montagne, la pedemontana del fiume Brenta, ma tutte le sue persone, imprese, comunità locali. Solo operando sotto un unico marchio si potrà garantire quella riconoscibilità di autenticità dalla forte valenza evocativa. I valori del Marchio d'Area risiedono principalmente nel patrimonio naturale e umano dell'area. È in questa dimensione che qualità dell'ambiente, storia, tradizioni, se comunicati in forma coesa e se accuratamente organizzati, potranno elevare l'attrattività, creare nuove opportunità, professioni, posti di lavoro, cultura.

©Giò Tarantini

**EN** Located in a region rich in treasures and artistic activities, Nove has a centuries-old tradition of craftsmanship that gives it the name of the City of Ceramics. A story that originates from the Veneto region. The gypsum was obtained from the Asiago plateau, the clay from the hills of Marostica, and the kaolin clay from the Tretto. A vast reality that, in Nove as in the rest of Veneto, has contributed to increasing the fame of Made in Italy with ancient and illustrious manufacturers of high quality. A path that has increasingly grown over time, until reaching 9010, a leader in the production of design and prestigious lighting that has established itself on the international scene.

**DE** Nove liegt in einer an Kunstschätzen und -aktivitäten reichen Gegend und besitzt eine jahrhundertealte Handwerkstradition, die sie weltweit als Stadt der Keramik bekanntgemacht hat. Diese Tradition ist der Landschaft des Veneto zu verdanken, denn in der Hochebene von Asiago wurde Gips abgebaut, aus den Hügeln von Marostica stammt der Ton und aus Tretto das Kaolin. Das Töpferhandwerk war in Nove und im gesamten Veneto weit verbreitet. Die berühmten alten Qualitätsmanufakturen haben dazu beigetragen, das Prestige des "Made in Italy" zu erhöhen. Am Ende eines weiten Weges sind wir schließlich zu 9010 gelangt, dessen Produkte sich international großer Beliebtheit erfreuen, nicht zuletzt auch wegen des besonderen Designs.

**FR** Située dans une région riche en trésors et en activités artistiques, Nove possède une tradition artisanale de plus d'un siècle, qui lui a valu sa renommée mondiale de Ville de la Céramique. Une histoire née dans le territoire vénitien : l'Altopiano di Asiago fournissait le gypse, les collines de Marostica l'argile, et le Tretto le kaolin. Une tradition solide qui, à Nove comme dans le reste de la Vénétie, a contribué à accroître la réputation du Made in Italy avec des manufactures anciennes et illustres, de grande qualité. Un parcours qui s'est développé au fil du temps, jusqu'à arriver à 9010, leader de la production d'éclairage design et prestigieux affirmant sa présence sur la scène internationale.

**EN** The Area Brand TERRITORI DEL BRENTA uniquely represents not only the geographical area of the valley, the mountains, and the foothills of the river Brenta, but all of its people, businesses, and local communities. Only by operating under a single brand will it be possible to guarantee that recognition of authenticity with a strong evocative value. The values of the Area Brand mainly reside in the natural and human heritage of the area. It is in this dimension that the quality of the environment, history, traditions if communicated in a cohesive form and if carefully organized, can increase attractiveness, and create new opportunities, professions, jobs, and culture.

**DE** Die Marke TERRITORI DEL BRENTA repräsentiert zweifelsohne nicht nur das geografische Gebiet des Tals, der Berge und des Vorgebirges am Fluss Brenta, sondern auch die Menschen, die dort leben, die dort ansässigen Betriebe und Gemeinden. Nur der Auftritt unter einer einzigen Marke kann die erkennbare Authentizität mit stark evokativem Wert garantieren. Die Werte dieser Marke liegen vor allem in der Natur und in den Menschen dieser Gegend. Umwelt, Geschichte und Traditionen können – wenn sie verständlich kommuniziert und sorgfältig organisiert sind – die Attraktivität erhöhen, neue Chancen, Berufe, Arbeitsplätze und Kultur zu schaffen.

**FR** Le label de la région du TERRITOIRE DE BRENTA représente de manière univoque non seulement la zone géographique de la vallée, les montagnes, le piémont du fleuve Brenta, mais aussi tous ses habitants, ses entreprises, ses communautés locales. Seul le fait de travailler sous un label unique peut garantir une authenticité d'une grande force évocatrice. Les valeurs du label de région, résident principalement dans le patrimoine naturel et humain de la région. C'est de cette manière que la qualité de l'environnement, l'histoire et les traditions pourront augmenter l'attractivité de la région, créer de nouvelles opportunités, des métiers, des postes de travail, la culture, à travers une communication uniforme et organisée.

# MATERIALI

Materials / Materialien / Matériaux

## CRISTALY<sup>®</sup> 9010



CRISTALY<sup>®</sup> è un compound originale di formulazione minerale con additivi e agenti leganti di origine naturale e rende da sempre i prodotti 9010 unici e riconoscibili.

EN CRISTALY<sup>®</sup> is an original compound of mineral formulation with natural additives and binding agents and it has always made 9010 products unique and recognizable.

DE CRISTALY<sup>®</sup> ist eine Verbindung aus Mineralstoffen, Zusatzstoffen und Bindemitteln natürlicher Herkunft, wodurch sich die Produkte 9010 auszeichnen und so einzigartig und erkennbar sind.

FR CRISTALY<sup>®</sup> est un composé original à la formulation minérale avec des additifs et des agents liants d'origine naturelle, qui rend depuis toujours les produits 9010 uniques et reconnaissables

**UV** **Resistenza ai raggi UV**  
UV resistant  
UV-Beständigkeit  
Résistant aux rayons UV

**Assenza di deformazione**  
Non deforming  
Keine Deformation  
Absence de déformation

**Colorabile con vernice all'acqua**  
Paintable with any water based color  
Mit Wasserfarben färbbar  
Colorable avec peinture à l'eau

**Sensazione di purezza al tatto**  
Sensation of pureness to the touch  
Gefühl einer samtigen Oberflächenstruktur  
Sensation de pureté

**Non infiammabile**  
Non flammable  
Nicht entflammbar  
Non inflammable

**Resistenza termica**  
Thermal resistant  
Thermische Beständigkeit  
Résistance thermique

**Resistente al gelo**  
Frost resistant  
Frostbeständig  
Résistant au gel

**Atossico**  
Non-toxic  
Nicht toxisch  
Non toxiques

**Assenza di reazioni chimiche**  
Absence of chemical reaction  
Ohne chemische Reaktion  
Absence de réactions chimiques

## ALUMITE<sup>®</sup> 9010



ALUMITE<sup>®</sup> è una speciale lega di alluminio che presenta innovative caratteristiche di leggerezza, brillantezza e resistenza agli agenti atmosferici, in esclusiva nei prodotti 9010.

EN ALUMITE<sup>®</sup> is a special aluminum alloy having innovative characteristics of lightness, brightness and resistance to atmospheric agents, exclusively in 9010 products.

DE ALUMITE<sup>®</sup> ist eine spezielle Aluminiumlegierung mit innovativen Merkmalen, die sie leicht, glänzend und witterungsbeständig machen. Sie wird exklusiv für die Produkte 9010 verwendet.

FR ALUMITE<sup>®</sup> est un alliage d'aluminium spécial doté de caractéristiques innovantes de légèreté, brillance et résistance aux intempéries, en exclusivité dans les produits 9010.

**Leggero**  
Light  
Leicht  
Léger

**Assenza di deformazione**  
Non deforming  
Keine Deformation  
Absence de déformation

**Alta capacità riflettente**  
High reflectivity  
Hohe Reflektivität  
Haute capacité réfléchissante

**Riciclabile**  
Recyclable  
Recyclebar  
Recyclable

**Resistente alla corrosione**  
Corrosion resistant  
Korrosionsbeständig  
Résistant à la corrosion

**Assenza di magnetismo**  
Non magnetic  
Abwesenheit von Magnetismus  
Absence de magnétisme

**Resistente al gelo**  
Frost resistant  
Frostbeständig  
Résistant au gel

**Atossico**  
Non-toxic  
Nicht toxisch  
Non toxiques

**Adatto per ambienti esterni**  
Suitable for outdoor use  
Geeignet für Outdoor  
Adapté pour l'extérieur

## CONCRETE<sup>®</sup> 9010



CONCRETE<sup>®</sup> è una fusione tra CRISTALY<sup>®</sup> e leganti cementizi, sviluppati da polimeri a base acquosa ad altissime prestazioni, senza contenuto di solventi nel rispetto della salute e dell'ambiente

EN CONCRETE<sup>®</sup> is a fusion of CRISTALY<sup>®</sup> and cement binders, developed from high performance water based polymers, without solvent content in respect of health and environment

DE CONCRETE<sup>®</sup> ist eine Verschmelzung von CRISTALY<sup>®</sup> und Zementbindemitteln, die von Hochleistungs-Polymeren auf Wasserbasis ohne Lösemittelgehalt zwecks Gesundheits- und Umweltschutz entwickelt werden.

FR CONCRETE<sup>®</sup> est une fusion entre CRISTALY<sup>®</sup> et des agents liants à base de ciment, développés à partir de polymères à base d'eau haute performance, sans solvants afin de respecter la santé et l'environnement.

**Adatto per ambienti esterni**  
Suitable for outdoor use  
Geeignet für Outdoor  
Adapté pour l'extérieur

**Assenza di deformazione**  
Non deforming  
Keine Deformation  
Non déformante

**Non infiammabile**  
Non flammable  
Nicht entflammbar  
Non inflammable

**UV** **Resistenza ai raggi UV**  
UV resistant  
UV-Beständigkeit  
Résistant aux rayons UV

**Resistenza termica**  
Thermal resistant  
Thermische Beständigkeit  
Résistance thermique

**Assenza di reazioni chimiche**  
Absence of chemical reaction  
Ohne chemische Reaktion  
Absence de réactions chimiques

**Alta resistenza agli urti**  
High Impact resistance  
Hohe Schlagbeständigkeit  
Haute résistance aux chocs

**Resistenza alla salinità**  
Salt corrosion resistant  
Salzkorrosionsbeständig  
Résistant aux agressions salines

**Resistente all'abrasione**  
Abrasion resistant  
Abriebbeständig  
Résistant à l'abrasion

IT Eventuali efflorescenze sono normali, dato le caratteristiche naturali del prodotto. Le efflorescenze sono una decolorazione causata da depositi cristallini di sali sulle superfici in calcestruzzo.

EN Any efflorescence is normal, given the natural characteristics of the product. Efflorescence is a discoloration caused by crystalline salt deposits on concrete surfaces.

DE Aufgrund der natürlichen Eigenschaften des Produkts können Ausblühungen auftreten, die als normale Erscheinung zu betrachten sind. Ausblühungen sind eine Dekolorierung, die durch kristalline Salzablagerungen auf Betonoberflächen entsteht.

FR Comme il s'agit d'un produit naturel, la présence éventuelle d'efflorescences est normale. Les efflorescences sont une décoloration causée par des dépôts de cristaux de sels sur les surfaces en ciment.

# MATERIALI

Materials / Materialien / Matériaux

## CONCRETE® indoor 9010

CONCRETE® indoor è uno speciale compound esclusivo 9010, frutto di una originale combinazione di argille minerali e cemento alleggerito.

EN CONCRETE® indoor is a special exclusive 9010 compound, being the result of an original combination of mineral clays and lightened cement.

DE CONCRETE® indoor ist eine exklusive, spezielle 9010 Verbindung, die das Ergebnis einer einzigartigen Kombination aus mineralischer Tonerde und Leichtzement ist.

FR CONCRETE® indoor est réalisé avec un composé spécial exclusif 9010, issu d'une combinaison originale d'argiles minérales et de ciment allégé.



**UV**  
Resistenza ai raggi UV  
UV resistant  
UV-Beständigkeit  
Résistant aux rayons UV

**Non infiammabile**  
Non flammable  
Nicht entflammbar  
Non inflammable

**Resistenza termica**  
Thermal resistant  
Thermische Beständigkeit  
Résistance thermique

**Atossico**  
Non-toxic  
Nicht toxisch  
Non toxiques

**Assenza di reazioni chimiche**  
Absence of chemical reaction  
Ohne chemische Reaktion  
Absence de réactions chimiques

**Assenza di deformazione**  
Non deforming  
Keine Deformation  
Absence de déformation

**Leggero**  
Light  
Leicht  
Léger

**Tocco materico**  
Materic touch  
Materialeffekt  
Touche Matière

## KERLITE

KERLITE è un materiale ceramico leggero, altamente resistente utilizzato nei prodotti 9010 in abbinamento a profili speciali in ALUMITE®.

EN KERLITE is a lightweight, highly resistant ceramic material used in 9010 products in combination with special ALUMITE® profiles

DE KERLITE ist ein leichtes, hochfestes keramisches Material, das für die 9010-Produkte in Verbindung mit Spezialprofilen aus ALUMITE® verwendet wird.

FR KERLITE est un matériau céramique léger et très résistant, utilisé dans les produits 9010 avec des profils spéciaux en ALUMITE®.



**UV**  
Resistenza ai raggi UV  
UV resistant  
UV-Beständigkeit  
Résistant aux Rayons UV

**Atossico**  
Non-toxic  
Nicht toxisch  
Non toxiques

**Resistenza termica**  
Thermal resistant  
Thermische Beständigkeit  
Résistance thermique

**Non infiammabile**  
Non flammable  
Nicht entflammbar  
Non inflammable

**Alta resistenza agli urti**  
High Impact resistance  
Hohe Schlagbeständigkeit  
Haute résistance aux chocs

**Assenza di reazioni chimiche**  
Absence of chemical reaction  
Ohne chemische Reaktion  
Absence de réactions chimiques

## CERAMICA 9010

La CERAMICA 9010 è realizzata con argille minerali selezionate, grazie ad un processo produttivo artigianale e frutto di un'antica tradizione manifatturiera.

EN 9010 CERAMIC is made with selected mineral clays, thanks to a handmade production process and being the result of an ancient manufacturing tradition.

DE Die KERAMIK 9010 besteht aus ausgewählter mineralischer Tonerde und wird mit einem handwerklichen Produktionsverfahren nach alter Tradition hergestellt.

FR La CERAMIQUE 9010 est réalisée à partir d'argiles minérales sélectionnées, grâce à un processus de production artisanale issu d'une longue tradition manufacturière.



**UV**  
Resistenza ai raggi UV  
UV resistant  
UV-Beständigkeit  
Résistant aux UV

**Finitura levigata**  
Smooth finish  
Glatte Oberfläche  
Texture Lisse

**Colorabile con vernice all'acqua**  
Paintable with any water based color  
Mit Wasserfarben färbbar  
Colorable avec couleurs à l'eau

**Non infiammabile**  
Non flammable  
Nicht entflammbar  
Non inflammable

**Atossico**  
Non-toxic  
Nicht toxisch  
Non toxiques

**Resistenza termica**  
Thermal resistant  
Thermische Beständigkeit  
Résistance thermique

**Assenza di reazioni chimiche**  
Absence of chemical reaction  
Ohne chemische Reaktion  
Absence de réactions chimiques

# FINITURE

Finishes / Ausführungen / Finitions

9010 offre un'ampia possibilità di finiture per una decorazione versatile che rispecchia le tendenze più contemporanee.

EN 9010 offer a wide range of finishes for a versatile decoration that reflects the most contemporary trends.

DE 9010 bietet eine breite Palette von Oberflächenverarbeitungen für vielseitige Anwendungen an.

FR 9010 propose une large gamme de finitions pour une décoration polyvalente reflétant les tendances les plus contemporaines.



Le finiture disponibili per ogni articolo sono consultabili nella pagina corrispondente. Siamo disponibili a valutare personalizzazioni su richiesta.

EN The finishes available for each article are indicated on the corresponding page. We are available to evaluate customizations on request.

DE Die für jeden Artikel verfügbaren Ausführungen sind auf der entsprechenden Seite angegeben. Wir stehen zur Verfügung, um individuelle Anfragen zu prüfen.

FR Les finitions disponibles pour chaque article sont indiquées sur la page correspondante. Nous sommes disponibles pour évaluer les personnalisations sur demande.

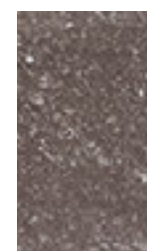

**Pietra marrone**  
Brown stone  
Brauner Stein  
Pierre brune

380



**Pietra grigia**  
Grey stone  
Grauer Stein  
Pierre Grise

381

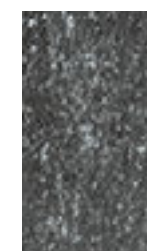

**Pietra nera**  
Black stone  
Schwarzer Stein  
Pierre Noire

382



**Corten**  
Corten

390



**Ossido**  
Oxide

391



**Foglia oro**  
Gold leaf  
Altgold  
Feuille d'or

670

## COLORI DEI MATERIALI

Colors of the materials / Farben der Materialien / Couleurs des matériaux

I prodotti in CRISTALY® e CERAMICA 9010 bianca possono essere colorati con qualsiasi colore all'acqua

EN Products made of CRISTALY® and white CERAMIC 9010 can be painted with any water based paint.

DE Die Produkte aus CRISTALY® und weisse KERAMIK 9010 können mit beliebiger Wasserfarbe gefärbt werden.

FR Les produits en CRISTALY® et CERAMIQUE 9010 blanche peuvent être colorés avec toutes les couleurs à l'eau.



CRISTALY®



**CONCRETE®**  
Grey  
368



**CONCRETE®**  
Darkgrey  
369



**CONCRETE® indoor**  
Grey

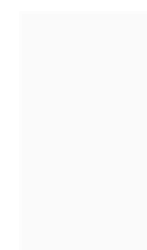

Ceramica 9010

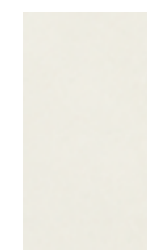

**Kerlite bianco**  
White Kerlite  
371



**Kerlite grigio**  
Grey Kerlite  
372



**Kerlite nero**  
Black Kerlite  
373

9010 propone da sempre innovative soluzioni a LED, che abbinate ai materiali esclusivi 9010 garantiscono elevato risparmio energetico, maggiore vita utile di esercizio, notevole riduzione dei costi di manutenzione e bassissimo impatto ambientale.

EN 9010 proposes more and more innovative LED solutions which offer considerable energy saving, longer working life as well as a considerable reduction in maintenance costs and very low environmental impact.

DE 9010 entwickelt ständig LED bestückte Leuchten, die äusserst energiesparsam sind, eine lange Lebensdauer und niedrige Wartungskosten aufweisen.

FR 9010 propose des solutions LED de plus en plus innovantes qui garantissent des économies d'énergie considérables, une longue durée de vie, une réduction considérable des coûts de maintenance et un très faible impact sur l'environnement.



SONO DISPONIBILI DATI FOTOMETRICI SU RICHIESTA  
PHOTOMETRIC DATA ARE AVAILABLE ON REQUEST  
PHOTOMETRISCHE DATEN AUF ANFRAGE VERFÜGBAR  
DONNÉES PHOTOMÉTRIQUES DISPONIBLES SUR DEMANDE



Per la collezione 9010 abbiamo scelto i migliori LED sul mercato, proposti in diversi wattaggi, temperature colore e lumen, al fine di soddisfare esigenze di applicazioni personalizzate. La temperatura colore standard dei nostri LED è 3000°K e sono disponibili le varianti 2700°K e 4000°K. La temperatura colore dei diodi è selezionata sull'ellisse MacAdam step 3, avendo quindi uno scostamento massimo dello standard di  $\pm 70^\circ\text{K}$ ; in questo modo garantisce la stessa tonalità di colore nel tempo, anche in caso di sostituzioni o integrazioni future. L'indice di resa cromatica (CRI) tipico è tra 85 e 90.

EN We chose for 9010 collection the best LED solutions, in a variety of wattage, colour temperature and lumen, in order to grant versatile and individual lighting propositions. Our LEDs have a standard colour temperature of 3000°K, and the versions with 2700°K and 4000°K are available. The colour temperature range on the MacAdam ellipse is step 3, the diodes are therefore guaranteed to have a maximum variation of  $\pm 70^\circ\text{K}$  from one order to the next; in this way we can guarantee that future orders will always have the same colour, even if the chipset is changed or upgraded. The typical color rating index (CRI) is between 85 and 90.

DE Wir haben für 9010 die besten LED's in verschiedenen Wattagen, Farbtemperaturen und Lumen ausgewählt, um vielseitige und individuelle Lichtlösungen zu gewähren. Alle LEDs haben eine Standard-Farbtemperatur von 3000°K; es sind auch Versionen mit 2700°K und 4000°K verfügbar. Die Farbtemperatur der Dioden kann mit einer 3-Step-MacAdam-Ellipse umschrieben werden, mit einer maximalen Abweichung vom Standard von  $\pm 70^\circ\text{K}$ . Dadurch wird eine gleichbleibende Farbtonalität auf Dauer garantiert, auch bei Ersatz oder zukünftigen Integrationen. Der Farbwiedergabeindex (CRI) ist zwischen 85 und 90.

FR Pour la collection 9010, nous avons choisi les meilleures LED sur le marché, proposés avec différentes puissances, températures de couleur et lumens, afin de satisfaire les exigences d'applications personnalisées. Nos LED ont température couleur standard de 3000°K et versions à 2700°K et 4000°K sont aussi disponibles. La température de la couleur des diodes est sélectionnée sur l'échelon 3 de l'ellipse de Macadam, avec un écart maximum de  $\pm 70^\circ\text{K}$  par rapport au standard. Cela garantit la conservation de la même tonalité de couleur au fil du temps, même en cas de remplacement ou d'intégrations futures. L'indice de rendu de couleur (IRC) typique est entre 85 et 90.



# ESEMPIO LETTURA PAGINA CATALOGO

Example for reading the catalogue page / Angaben für das Lesen der Katalogseite / Informations pour lire la page du catalogue

**Sezione**  
Section  
Produktgruppe

**Materiale**  
Material  
Matériel

**Direzione della luce**  
Direction of Light  
Lichtrichtung  
Direction de la lumière

**INCASSO A PARETE**  
Wall recessed lighting  
Wand-Einbauleuchten  
Encastrés Muraux

**CRISTALY<sup>®</sup>** made in Italy

CE III C.C. [m.A.] IP20

**Marchi/Classe di isolamento/Grado di protezione/SIMBOLI**  
Marks/Insulation class/Protection degree/ SYMBOLS  
Kennzeichnung/Schutzklasse /Schutzart/ SYMBOLE  
Marques / Classe d'isolation / Degré de protection/ SYMBOLES

**Caratteristiche parti elettriche**  
Characteristics of electrical parts  
Eigenschaften elektrischer Teile  
Caractéristiques des parties électriques

**Codice articolo**  
Article code  
Artikel Code

**DATI TECNICI / TECHNICAL DATA**

2365B-3031	LED 16.5W-700mA-2600lm-3000°K-CRI85
2365B-2731	LED 16.5W-700mA-2450lm-2700°K-CRI85
2365B-4031	LED 16.5W-700mA-2750lm-4000°K-CRI85
026.255	DRIVER ON/OFF min11.9W max18.2W 700mA
026.256	DRIVER ON/OFF min24.9W max35.7W 700mA
026.219	DRIVER DIM PUSH/0-10V/DALI 19.6W 700mA
026.207	DRIVER DIM 0-10V 60.2W 700mA
026.206	DRIVER DIM PUSH/DALI 60.2W 700mA

**ACCESSORI / ACCESSORIES**

023.408	Controcassa per muratura / Housing box for brickwork / Einbaugehäuse für Betonwand / Boîtier pour béton/briques [325x285x100mm]
099.142	Pg.415 Kit emergenza / Emergency Kit

**2365B**

3,65 Kg

**Misure**  
Measurements  
Abmessungen  
Mesures

**DATI TECNICI / TECHNICAL DATA**

8949B-35	GU10 ø111 MAX 35W-240V
8949B-92	G53 (QR111) MAX 20W-12V
8949B-3008	LED 13W-700mA-1600lm-3000°K-CRI90
8949B-2708	LED 13W-700mA-1500lm-2700°K-CRI90
8949B-4008	LED 13W-700mA-1700lm-4000°K-CRI90
026.255	DRIVER ON/OFF min11.9W max18.2W 700mA
026.256	DRIVER ON/OFF min24.9W max35.7W 700mA
026.219	DRIVER DIM PUSH/0-10V/DALI 19.6W 700mA
026.207	DRIVER DIM 0-10V 60.2W 700mA
026.206	DRIVER DIM PUSH/DALI 60.2W 700mA
8949B-3010	LED 18W-500mA-2400lm-3000°K-CRI85
8949B-2710	LED 18W-500mA-2280lm-2700°K-CRI85
8949B-4010	LED 18W-500mA-2540lm-4000°K-CRI85
026.254	DRIVER ON/OFF min16.5W max23.5W 500mA
026.219	DRIVER DIM PUSH/0-10V/DALI 20W 500mA
026.207	DRIVER DIM 0-10V 45W 500mA
026.206	DRIVER DIM PUSH/DALI 45W 500mA

**Varianti parti elettriche**  
Electrical parts available  
Verfügbare elektrische Teile  
Parties électriques disponibles

**Alimentatori abbinabili**  
Suitable power supplies  
Geeignete Netzteile  
Alimentations correspondantes







**Varianti parti elettriche**  
Electrical parts available  
Verfügbare elektrische Teile  
Parties électriques disponibles

**Alimentatori abbinabili**  
Suitable power supplies  
Geeignete Netzteile  
Alimentations correspondantes

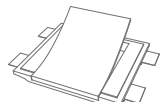
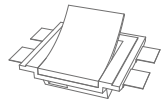
**Descrizione**  
Description  
Beschreibung

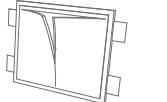
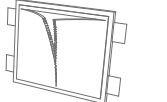
# INCASSO A PARETE

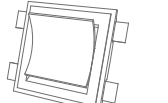
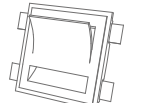
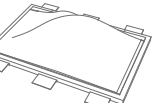
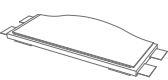
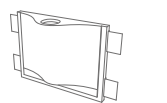
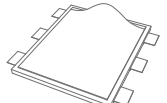
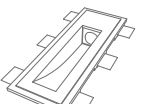
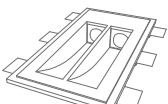
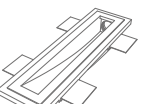
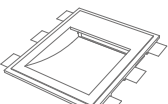
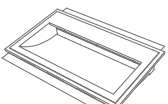
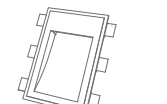
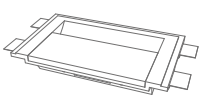
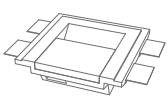
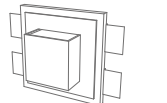
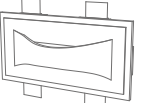
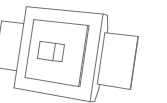
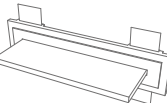
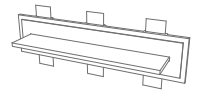
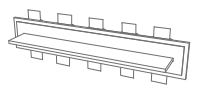
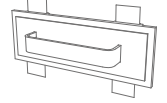
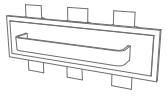
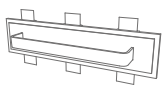
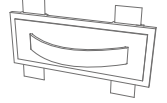
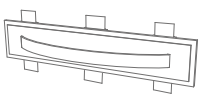
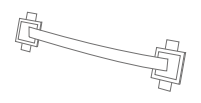
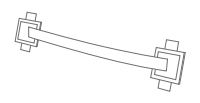
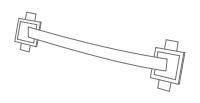
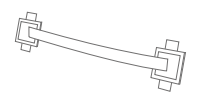
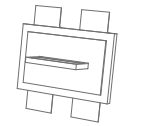
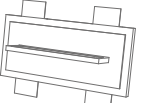
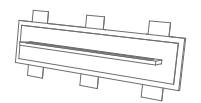
Wall recessed lighting  
Wand-Einbauleuchten  
Encastrés Muraux

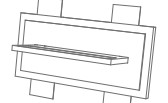
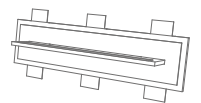
					
2365B p.21	<b>NEW</b> 2365E p.21	<b>NEW</b> 2365G p.21	2369A p.23	2371A p.23	2393 p.23
					
2402F p.25	2402G p.25	<b>NEW</b> 2372B p.26	2436 p.27	2446 p.27	<b>NEW</b> 2446B p.27
					
2414B p.31	2415B p.31	2417 p.31	2416A p.33	2416B p.33	2416C p.33
					
<b>NEW</b> 2416D p.35	<b>NEW</b> 2416E p.35	2618 p.37	2619 p.37	<b>NEW</b> 2466B p.37	2484A p.41
					
2484B p.41	2484C p.41	2485A p.45	2485B p.45	2485C p.45	2486A p.47
					
2486B p.47	2486C p.48	2486D p.49	2486E p.49	2486F p.49	<b>NEW</b> 2508A p.53
					
<b>NEW</b> 2508B p.53	<b>NEW</b> 2508C p.53	<b>NEW</b> 2508F p.55	<b>NEW</b> 2508G p.55	<b>NEW</b> 2508H p.55	

# INCASSO A PARETE

## Wall recessed lighting

## Wand-Einbauleuchten

## Encastrés Muraux

CRISTALY®

made in Italy

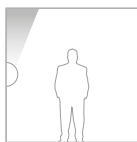

CASAMBI Pg.408

Art. 2365B - Private house - Ancona, Italy



Sistema Multitaglia  
Multi-size system  
P.417



### DATI TECNICI / TECHNICAL DATA

2365B-3031	LED 16.5W-700mA-2600lm-3000°K-CRI85
2365B-2731	LED 16.5W-700mA-2450lm-2700°K-CRI85
2365B-4031	LED 16.5W-700mA-2750lm-4000°K-CRI85
026.255	DRIVER ON/OFF min11.9W max18.2W 700mA
026.256	DRIVER ON/OFF min24.9W max35.7W 700mA
026.219	DRIVER DIM PUSH/0-10V/DALI 19.6W 700mA
026.207	DRIVER DIM 0-10V 60.2W 700mA
026.206	DRIVER DIM PUSH/DALI 60.2W 700mA

### ACCESSORI / ACCESSORIES

023.408	Controcassa per muratura / Housing box for brickwork / Einbaugeschäuse für Betonwand / Boîtier pour béton/briques [325x285x100mm]
099.142	Pg.415 Kit emergenza / Emergency Kit

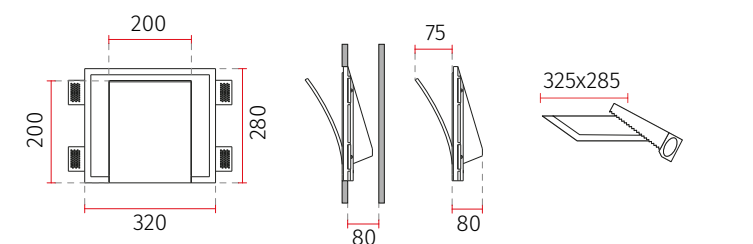

### DATI TECNICI / TECHNICAL DATA

2365E-30156	LED 9W-700mA-1350lm-3000°K-CRI85
2365E-27156	LED 9W-700mA-1300lm-2700°K-CRI85
2365E-40156	LED 9W-700mA-1400lm-4000°K-CRI85
026.173	DRIVER ON/OFF min7W max19.6W 700mA
026.239	DRIVER ON/OFF min17.5W max24.5W 700mA
026.256	DRIVER ON/OFF min24.9W max35.7W 700mA
026.219	DRIVER DIM PUSH/0-10V/DALI 19.6W 700mA
026.207	DRIVER DIM 0-10V 60.2W 700mA
026.206	DRIVER DIM PUSH/DALI 60.2W 700mA

### ACCESSORI / ACCESSORIES

023.495	Controcassa per muratura / Housing box for brickwork / Einbaugeschäuse für Betonwand / Boîtier pour béton/briques [220x220x75mm]
099.142	Pg.415 Kit emergenza / Emergency Kit
024.319	Vetro di protezione / Protection glass / Schutzglas / Verre de protection

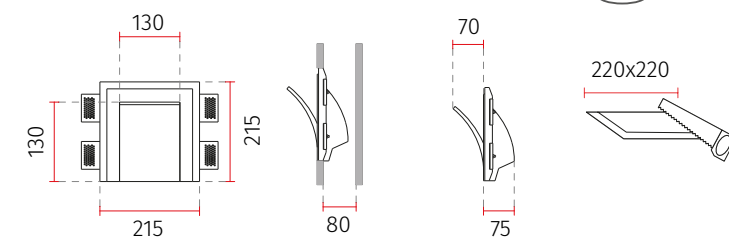

### DATI TECNICI / TECHNICAL DATA

2365G-3032	LED 21.5W-700mA-3250lm-3000°K-CRI85
2365G-2732	LED 21.5W-700mA-3100lm-2700°K-CRI85
2365G-4032	LED 21.5W-700mA-3400lm-4000°K-CRI85
026.239	DRIVER ON/OFF min17.5W max24.5W 700mA
026.207	DRIVER DIM 0-10V 60.2W 700mA
026.206	DRIVER DIM PUSH/DALI 60.2W 700mA

### ACCESSORI / ACCESSORIES

023.4012	Controcassa per muratura / Housing box for brickwork / Einbaugeschäuse für Betonwand / Boîtier pour béton/briques [405x255x80mm]
099.142	Pg.415 Kit emergenza / Emergency Kit
024.320	Vetro di protezione / Protection glass / Schutzglas / Verre de protection

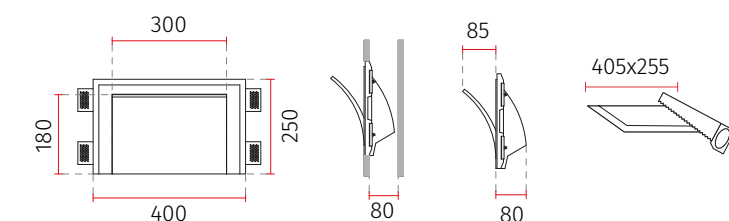

IT Misure espresse in mm, tolleranza +/- 1-2 mm. L'azienda si riserva la facoltà di apportare variazioni di dati caratteristici, materiali, design, stili, tonalità, senza alcun preavviso.  
EN Measures in mm, tolerance +/- 1/2 mm. The company reserves the right to carry out variations to technical details, materials, design, style, colors with no previous notice.

DE Die Masse sind in mm, mit einer Tolleranz von +/- 1-2 mm ausgedrückt. Die Firma behält sich das Recht vor ohne Voranmeldung Änderungen an den Werkstoffen, am Design, am Stil und an der Färbung vorzunehmen.  
FR Mesures en mm, tolérance +/- 1/2 mm. La société se réserve le droit de modifier sans préavis les détails techniques, les matériaux, le design, le style et les couleurs.

2365B



NEW 2365E



NEW 2365G



# INCASSO A PARETE

## Wall recessed lighting

## Wand-Einbauleuchten

## Encastrés Muraux

CRISTALY®

made in Italy

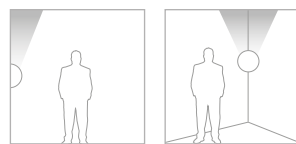

2393



CASAMBI Pg.408

Art. 2369A - Private house - London, UK



Art. 2393 - Private house - Firenze, Italy



### 2369A - 2371A:

Sistema Multitaglia  
Multi-size system  
P.417



### 2369A - 2371A:

LED 13W  
compatibile con  
GU10 Ø35 mm

EN LED 13W  
is compatible with  
GU10 Ø35mm

DE LED 13W  
kompatibel mit  
GU10 Ø35 mm

FR Compatibilité  
LED 13W avec  
GU10 Ø35 mm

### DATI TECNICI / TECHNICAL DATA

2369A-35	GU10 Ø35 MAX 5W-240V
2369A-3008	LED 13W-700mA-1600lm-3000°K-CRI90
2369A-2708	LED 13W-700mA-1500lm-2700°K-CRI90
2369A-4008	LED 13W-700mA-1700lm-4000°K-CRI90
026.255	DRIVER ON/OFF min11.9W max18.2W 700mA
026.256	DRIVER ON/OFF min24.9W max35.7W 700mA
026.219	DRIVER DIM PUSH/0-10V/DALI 19.6W 700mA
026.207	DRIVER DIM 0-10V 60.2W 700mA
026.206	DRIVER DIM PUSH/DALI 60.2W 700mA

### ACCESSORI / ACCESSORIES

023.476	Controcassa per muratura / Housing box for brickwork / Einbaugehäuse für Betonwand / Boîtier pour béton/briques [355x305x50mm]
099.142	Pg.415 Kit emergenza / Emergency Kit
L007	LED GU10 Ø35mm LED 3.2W-220-240V
021.226	Portalamпада / Lampholder / Lampenfassung / Source GU4

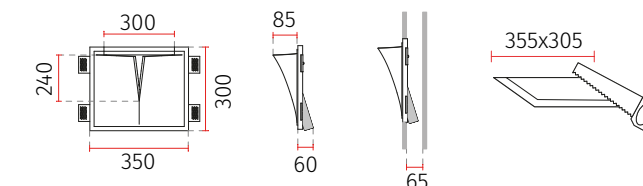

2369A



3 Kg

### DATI TECNICI / TECHNICAL DATA

2371A-35	GU10 Ø35 MAX 5W-240V
2371A-3008	LED 13W-700mA-1600lm-3000°K-CRI90
2371A-2708	LED 13W-700mA-1500lm-2700°K-CRI90
2371A-4008	LED 13W-700mA-1700lm-4000°K-CRI90
026.255	DRIVER ON/OFF min11.9W max18.2W 700mA
026.256	DRIVER ON/OFF min24.9W max35.7W 700mA
026.219	DRIVER DIM PUSH/0-10V/DALI 19.6W 700mA
026.207	DRIVER DIM 0-10V 60.2W 700mA
026.206	DRIVER DIM PUSH/DALI 60.2W 700mA

### ACCESSORI / ACCESSORIES

023.476	Controcassa per muratura / Housing box for brickwork / Einbaugehäuse für Betonwand / Boîtier pour béton/briques [355x305x50mm]
099.142	Pg.415 Kit emergenza / Emergency Kit
L007	LED GU10 Ø35mm LED 3.2W-220-240V
021.226	Portalamпада / Lampholder / Lampenfassung / Source GU4

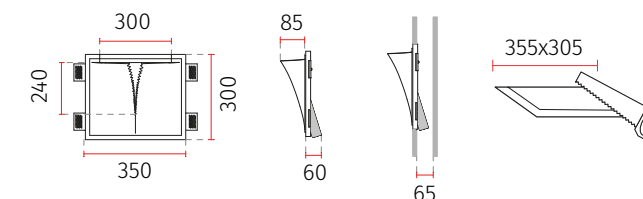

2371A



3 Kg

### DATI TECNICI / TECHNICAL DATA

2393-3008	LED 13W-700mA-1600lm-3000°K-CRI90
2393-2708	LED 13W-700mA-1500lm-2700°K-CRI90
2393-4008	LED 13W-700mA-1700lm-4000°K-CRI90
026.255	DRIVER ON/OFF min11.9W max18.2W 700mA
026.256	DRIVER ON/OFF min24.9W max35.7W 700mA
026.219	DRIVER DIM PUSH/0-10V/DALI 19.6W 700mA
026.207	DRIVER DIM 0-10V 60.2W 700mA
026.206	DRIVER DIM PUSH/DALI 60.2W 700mA

### ACCESSORI / ACCESSORIES

099.142	Pg.415 Kit emergenza / Emergency Kit
---------	--------------------------------------

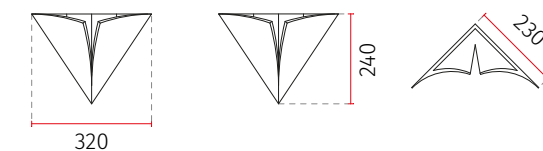

2393



1 Kg

IT Misure espresse in mm, tolleranza +/- 1-2 mm. L'azienda si riserva la facoltà di apportare variazioni di dati caratteristici, materiali, design, stili, tonalità, senza alcun preavviso.  
EN Measures in mm, tolerance +/- 1/2 mm. The company reserves the right to carry out variations to technical details, materials, design, style, colors with no previous notice.

DE Die Masse sind in mm, mit einer Tolleranz von +/- 1-2 mm ausgedrückt. Die Firma behält sich das Recht vor ohne Voranmeldung Änderungen an den Werkstoffen, am Design, am Stil und an der Färbung vorzunehmen.  
FR Mesures en mm, tolérance +/- 1/2 mm. La société se réserve le droit de modifier sans préavis les détails techniques, les matériaux, le design, le style et les couleurs.

# INCASSO A PARETE

## Wall recessed lighting

## Wand-Einbauleuchten

## Encastrés Muraux

CRISTALY®

made in Italy

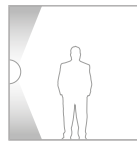

CASAMBI Pg.408

Art. 2402F - Private house - Bologna, Italy



Sistema Multitaglia  
Multi-size system  
P.417



### DATI TECNICI / TECHNICAL DATA

2402F-3033	LED 16.5W-700mA-2600lm-3000°K-CRI85
2402F-2733	LED 16.5W-700mA-2450lm-2700°K-CRI85
2402F-4033	LED 16.5W-700mA-2750lm-4000°K-CRI85
026.255	DRIVER ON/OFF min11.9W max18.2W 700mA
026.256	DRIVER ON/OFF min24.9W max35.7W 700mA
026.219	DRIVER DIM PUSH/0-10V/DALI 19.6W 700mA
026.207	DRIVER DIM 0-10V 60.2W 700mA
026.206	DRIVER DIM PUSH/DALI 60.2W 700mA

### ACCESSORI / ACCESSORIES

023.490	Controcassa per muratura / Housing box for brickwork / Einbaugehäuse für Betonwand / Boîtier pour béton/briques [320x320x85mm]
099.142	Pg.415 Kit emergenza / Emergency Kit

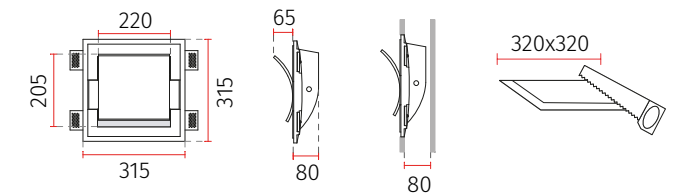

2402F

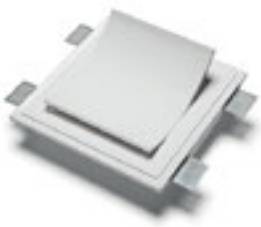

4 Kg

### DATI TECNICI / TECHNICAL DATA

2402G-3033	LED 16.5W-700mA-2600lm-3000°K-CRI85
2402G-2733	LED 16.5W-700mA-2450lm-2700°K-CRI85
2402G-4033	LED 16.5W-700mA-2750lm-4000°K-CRI85
026.255	DRIVER ON/OFF min11.9W max18.2W 700mA
026.256	DRIVER ON/OFF min24.9W max35.7W 700mA
026.219	DRIVER DIM PUSH/0-10V/DALI 19.6W 700mA
026.207	DRIVER DIM 0-10V 60.2W 700mA
026.206	DRIVER DIM PUSH/DALI 60.2W 700mA

### ACCESSORI / ACCESSORIES

023.490	Controcassa per muratura / Housing box for brickwork / Einbaugehäuse für Betonwand / Boîtier pour béton/briques [320x320x85mm]
099.142	Pg.415 Kit emergenza / Emergency Kit

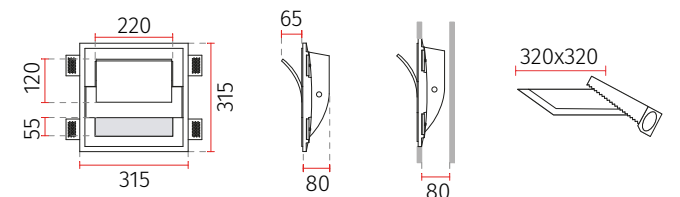

2402G



4 Kg

IT Misure espresse in mm, tolleranza +/- 1-2 mm. L'azienda si riserva la facoltà di apportare variazioni di dati caratteristici, materiali, design, stili, tonalità, senza alcun preavviso.  
EN Measures in mm, tolerance +/- 1/2 mm. The company reserves the right to carry out variations to technical details, materials, design, style, colors with no previous notice.

DE Die Masse sind in mm, mit einer Tolleranz von +/- 1-2 mm ausgedrückt. Die Firma behält sich das Recht vor ohne Voranmeldung Änderungen an den Werkstoffen, am Design, am Stil und an der Färbung vorzunehmen.  
FR Mesures en mm, tolérance +/- 1/2 mm. La société se réserve le droit de modifier sans préavis les détails techniques, les matériaux, le design, le style et les couleurs.

# INCASSO A PARETE

## Wall recessed lighting

## Wand-Einbauleuchten

## Encastrés Muraux

CRISTALY®

made in Italy

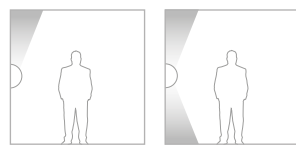

C.A.C. [m.A.] 2372B C.V. [v] 2436 CASAMBI Pg.408

Art. 2372B



Sistema Multitaglia  
Multi-size system  
P.417



### DATI TECNICI / TECHNICAL DATA

2436-3005	LED 9.5W-24Vdc-850lm-3000°K-CRI85
2436-2705	LED 9.5W-24Vdc-800lm-2700°K-CRI85
2436-4005	LED 9.5W-24Vdc-900lm-4000°K-CRI85
026.258	DRIVER ON/OFF 12W 24V
026.259	DRIVER ON/OFF 36W 24V
026.260	DRIVER ON/OFF 60W 24V
026.261	DRIVER ON/OFF 150W 24V
026.262	DRIVER ON/OFF 240W 24V
026.219	DRIVER DIM PUSH/0-10V/DALI 21.6W 24V
026.209	DRIVER DIM PUSH/1-10V 60W 24V
026.190+026.261	DRIVER DIM PUSH/0-10V/DALI 150W 24V
026.190+026.262	DRIVER DIM PUSH/0-10V/DALI 240W 24V

### ACCESSORI / ACCESSORIES

023.437	Controcassa per muratura / Housing box for brickwork / Einbaugehäuse für Betonwand / Boîtier pour béton/briques [525x185x50mm]
099.142	Pg.415 Kit emergenza / Emergency Kit

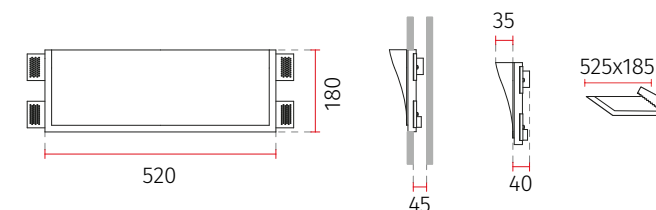

3 Kg

### DATI TECNICI / TECHNICAL DATA

2446-96	GUS.3+GU4 MAX 10W+5W-12V
---------	--------------------------

### ACCESSORI / ACCESSORIES

023.438	Controcassa per muratura / Housing box for brickwork / Einbaugehäuse für Betonwand / Boîtier pour béton/briques [315x245x50mm]
---------	--

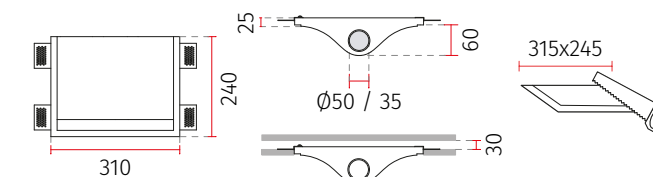

1,9 Kg

# 2446



# 2372B NEW



4,45 Kg

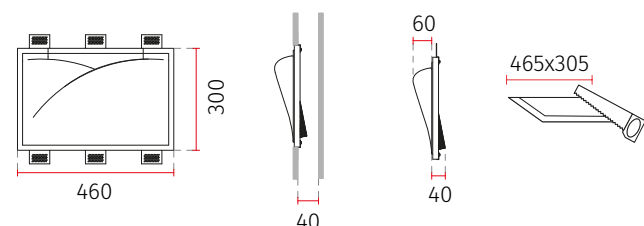

### DATI TECNICI / TECHNICAL DATA

2372B-3008	LED 13W-700mA-1600lm-3000°K-CRI90
2372B-2708	LED 13W-700mA-1500lm-2700°K-CRI90
2372B-4008	LED 13W-700mA-1700lm-4000°K-CRI90
026.255	DRIVER ON/OFF min11.9W max18.2W 700mA
026.256	DRIVER ON/OFF min24.9W max35.7W 700mA
026.219	DRIVER DIM PUSH/0-10V/DALI 19.6W 700mA
026.207	DRIVER DIM 0-10V 60.2W 700mA
026.206	DRIVER DIM PUSH/DALI 60.2W 700mA

### ACCESSORI / ACCESSORIES

023.4008	Controcassa per muratura / Housing box for brickwork / Einbaugehäuse für Betonwand / Boîtier pour béton/briques [305x465x85mm]
099.142	Pg.415 Kit emergenza / Emergency Kit

### DATI TECNICI / TECHNICAL DATA

2446B-35	GU10 Ø50 MAX 10W-240V
----------	-----------------------

### ACCESSORI / ACCESSORIES

023.488	Controcassa per muratura / Housing box for brickwork / Einbaugehäuse für Betonwand / Boîtier pour béton/briques [410x340x85mm]
021.231	Portalamпада / Lampholder / Lampenfassung / Source GU5.3

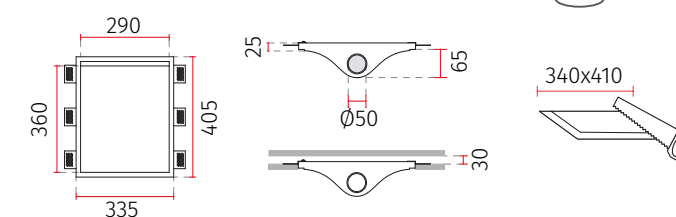

3 Kg

# NEW 2446B



IT Misure espresse in mm, tolleranza +/- 1-2 mm. L'azienda si riserva la facoltà di apportare variazioni di dati caratteristici, materiali, design, stili, tonalità, senza alcun preavviso.  
EN Measures in mm, tolerance +/- 1/2 mm. The company reserves the right to carry out variations to technical details, materials, design, style, colors with no previous notice.

DE Die Masse sind in mm, mit einer Tolleranz von +/- 1-2 mm ausgedrückt. Die Firma behält sich das Recht vor ohne Voranmeldung Änderungen an den Werkstoffen, am Design, am Stil und an der Färbung vorzunehmen.  
FR Mesures en mm, tolérance +/- 1/2 mm. La société se réserve le droit de modifier sans préavis les détails techniques, les matériaux, le design, le style et les couleurs.

Art. 2446 / 4195A - Hotel - Cremona, Italy



Art. 2446B



# INCASSO A PARETE

## Wall recessed lighting

## Wand-Einbauleuchten

## Encastrés Muraux

CRISTALY®

made in Italy

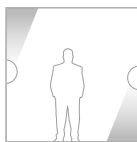

Art. 2417 - Private house - Ferrara, Italy



Sistema Multitaglia  
Multi-size system  
P.417



### DATI TECNICI / TECHNICAL DATA

2414B-35 GU5.3+GU4 MAX 10W+5W-12V

### ACCESSORI / ACCESSORIES

023.486	Controcassa per muratura / Housing box for brickwork / Einbaugehäuse für Betonwand / Boîtier pour béton/briques [470x170x85mm]
L001-3018	LED 8W-220-240V-650lm-3000°K-CRI85-60°
L002-3020	LED 12W-220-240V-1000lm-3000°K-CRI85-60°
L004-3018	LED 8W-220-240V-650lm-3000°K-CRI85-30°
L005-3020	LED 12W-220-240V-1000lm-3000°K-CRI85-30°
021.231	Portalamпада / Lampholder / Fassung / Douille: GU5.3

# 2414B



2,65 Kg

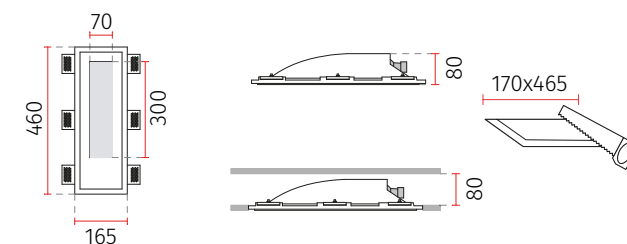

### DATI TECNICI / TECHNICAL DATA

2415B-35 GU10 ø50 MAX 2x35W-240V

### ACCESSORI / ACCESSORIES

023.487	Controcassa per muratura / Housing box for brickwork / Einbaugehäuse für Betonwand / Boîtier pour béton/briques [465x255x85mm]
L001-3018	LED 8W-220-240V-650lm-3000°K-CRI85-60°
L002-3020	LED 12W-220-240V-1000lm-3000°K-CRI85-60°
L004-3018	LED 8W-220-240V-650lm-3000°K-CRI85-30°
L005-3020	LED 12W-220-240V-1000lm-3000°K-CRI85-30°
021.231	Portalamпада / Lampholder / Fassung / Douille: GU5.3

# 2415B



3,9 Kg

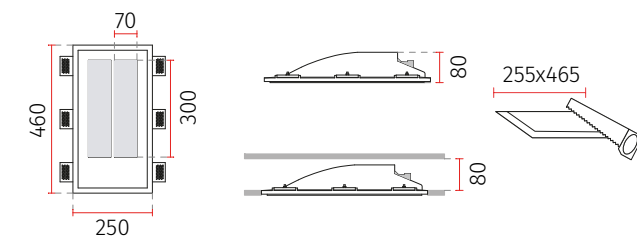

### DATI TECNICI / TECHNICAL DATA

2417-35 GU10 ø50 MAX 2x35W-240V

### ACCESSORI / ACCESSORIES

023.436	Controcassa per muratura / Housing box for brickwork / Einbaugehäuse für Betonwand / Boîtier pour béton/briques [105x410x80mm]
L007	LED GU10 Ø35mm LED 3.2W-220-240V
021.226	Portalamпада / Lampholder / Fassung / Douille: GU4

# 2417



1,5 Kg

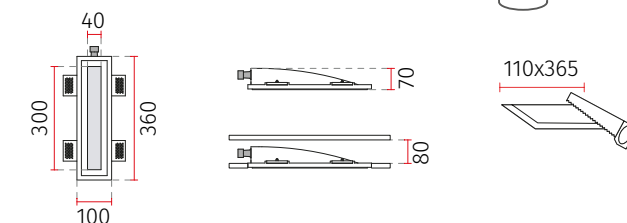

IT Misure espresse in mm, tolleranza +/- 1-2 mm. L'azienda si riserva la facoltà di apportare variazioni di dati caratteristici, materiali, design, stili, tonalità, senza alcun preavviso.  
EN Measures in mm, tolerance +/- 1/2 mm. The company reserves the right to carry out variations to technical details, materials, design, style, colors with no previous notice.

DE Die Maße sind in mm, mit einer Tolleranz von +/- 1-2 mm ausgedrückt. Die Firma behält sich das Recht vor ohne Voranmeldung Änderungen an den Werkstoffen, am Design, am Stil und an der Färbung vorzunehmen.  
FR Mesures en mm, tolérance +/- 1/2 mm. La société se réserve le droit de modifier sans préavis les détails techniques, les matériaux, le design, le style et les couleurs.



# INCASSO A PARETE

## Wall recessed lighting

## Wand-Einbauleuchten

## Encastrés Muraux

CRISTALY®

made in Italy

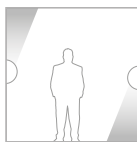

CASAMBI Pg.408

Art. 2416C / 4276 - Private house - Aosta, Italy



Sistema Multitaglia  
Multi-size system  
P.417



### DATI TECNICI / TECHNICAL DATA

2416A-3031	LED 16.5W-700mA-2600lm-3000°K-CRI85
2416A-2731	LED 16.5W-700mA-2450lm-2700°K-CRI85
2416A-4031	LED 16.5W-700mA-2750lm-4000°K-CRI85
026.255	DRIVER ON/OFF min11.9W max18.2W 700mA
026.256	DRIVER ON/OFF min24.9W max35.7W 700mA
026.219	DRIVER DIM PUSH/0-10V/DALI 19.6W 700mA
026.207	DRIVER DIM 0-10V 60.2W 700mA
026.206	DRIVER DIM PUSH/DALI 60.2W 700mA

### ACCESSORI / ACCESSORIES

023.488	Controcassa per muratura / Housing box for brickwork / Einbaugehäuse für Betonwand / Boîtier pour béton/briques [410x340x85mm]
099.142	Pg.415 Kit emergenza / Emergency Kit
024.321	Vetro di protezione (solo con luce verso l'alto) / Protection glass (only with light upwards) / Schutzglas (nur bei Licht nach oben) / Verre de protection (uniquement avec lumière vers le haut)

2416A



4,15 Kg

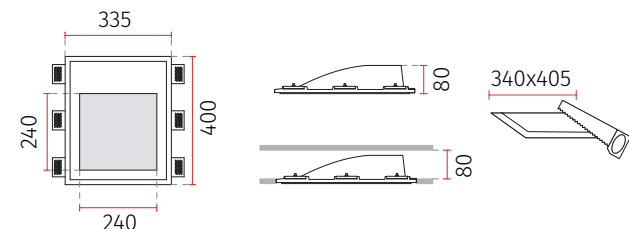

### DATI TECNICI / TECHNICAL DATA

2416B-3034	LED 32W-1050mA-4800lm-3000°K-CRI85
2416B-2734	LED 32W-1050mA-4600lm-2700°K-CRI85
2416B-4034	LED 32W-1050mA-5000lm-4000°K-CRI85
026.220	DRIVER ON/OFF min11.6W max34.7W 1050mA
026.207	DRIVER DIM 0-10V 59.9W 1050mA
026.206	DRIVER DIM PUSH/DALI 59.9W 1050mA

### ACCESSORI / ACCESSORIES

023.460	Controcassa per muratura / Housing box for brickwork / Einbaugehäuse für Betonwand / Boîtier pour béton/briques [615x360x110mm]
099.142	Pg.415 Kit emergenza / Emergency Kit
024.322	Vetro di protezione (solo con luce verso l'alto) / Protection glass (only with light upwards) / Schutzglas (nur bei Licht nach oben) / Verre de protection (uniquement avec lumière vers le haut)

2416B



7,5 Kg

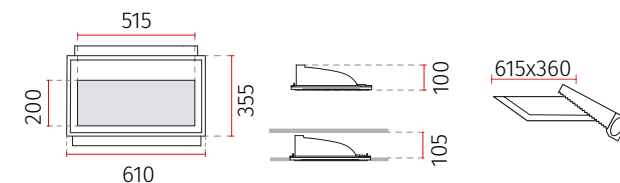

### DATI TECNICI / TECHNICAL DATA

2416C-3031	LED 16.5W-700mA-2600lm-3000°K-CRI85
2416C-2731	LED 16.5W-700mA-2450lm-2700°K-CRI85
2416C-4031	LED 16.5W-700mA-2750lm-4000°K-CRI85
026.255	DRIVER ON/OFF min11.9W max18.2W 700mA
026.256	DRIVER ON/OFF min24.9W max35.7W 700mA
026.219	DRIVER DIM PUSH/0-10V/DALI 19.6W 700mA
026.207	DRIVER DIM 0-10V 60.2W 700mA
026.206	DRIVER DIM PUSH/DALI 60.2W 700mA

### ACCESSORI / ACCESSORIES

023.4008	Controcassa per muratura / Housing box for brickwork / Einbaugehäuse für Betonwand / Boîtier pour béton/briques [305x465x85mm]
099.142	Pg.415 Kit emergenza / Emergency Kit
024.323	Vetro di protezione (solo con luce verso l'alto) / Protection glass (only with light upwards) / Schutzglas (nur bei Licht nach oben) / Verre de protection (uniquement avec lumière vers le haut)

2416C



4,9 Kg

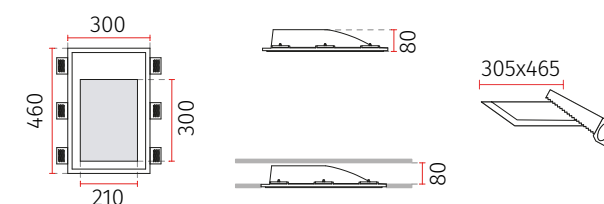

IT Misure espresse in mm, tolleranza +/- 1-2 mm. L'azienda si riserva la facoltà di apportare variazioni di dati caratteristici, materiali, design, stili, tonalità, senza alcun preavviso.  
EN Measures in mm, tolerance +/- 1/2 mm. The company reserves the right to carry out variations to technical details, materials, design, style, colors with no previous notice.

DE Die Maße sind in mm, mit einer Toleranz von +/- 1-2 mm ausgedrückt. Die Firma behält sich das Recht vor ohne Voranmeldung Änderungen an den Werkstoffen, am Design, am Stil und an der Färbung vorzunehmen.  
FR Mesures en mm, tolérance +/- 1/2 mm. La société se réserve le droit de modifier sans préavis les détails techniques, les matériaux, le design, le style et les couleurs.

# INCASSO A PARETE

## Wall recessed lighting

## Wand-Einbauleuchten

## Encastrés Muraux

CRISTALY®

made in Italy



CASAMBI Pg.408

Art. 2416D / 4193C - Private house - Verona, Italy



### DATI TECNICI / TECHNICAL DATA

2416D-3032	LED 21.5W-700mA-3250lm-3000°K-CRI85
2416D-2732	LED 21.5W-700mA-3100lm-2700°K-CRI85
2416D-4032	LED 21.5W-700mA-3400lm-4000°K-CRI85
026.239	DRIVER ON/OFF min17.5W max24.5W 700mA
026.207	DRIVER DIM 0-10V 60.2W 700mA
026.206	DRIVER DIM PUSH/DALI 60.2W 700mA

### ACCESSORI / ACCESSORIES

023.4012	Controcassa per muratura / Housing box for brickwork / Einbaugehäuse für Betonwand / Boîtier pour béton/briques [405x255x80mm]
099.142	Pg.415 Kit emergenza / Emergency Kit
024.325	Vetro di protezione / Protection glass / Schutzglas / Verre de protection

NEW 2416D



3,75 Kg

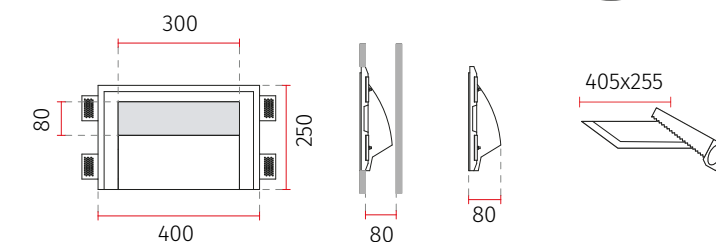

### DATI TECNICI / TECHNICAL DATA

2416E-30156	LED 9W-700mA-1350lm-3000°K-CRI85
2416E-27156	LED 9W-700mA-1300lm-2700°K-CRI85
2416E-40156	LED 9W-700mA-1400lm-4000°K-CRI85
026.173	DRIVER ON/OFF min7W max19.6W 700mA
026.239	DRIVER ON/OFF min17.5W max24.5W 700mA
026.256	DRIVER ON/OFF min24.9W max35.7W 700mA
026.219	DRIVER DIM PUSH/0-10V/DALI 19.6W 700mA
026.207	DRIVER DIM 0-10V 60.2W 700mA
026.206	DRIVER DIM PUSH/DALI 60.2W 700mA

### ACCESSORI / ACCESSORIES

023.495	Controcassa per muratura / Housing box for brickwork / Einbaugehäuse für Betonwand / Boîtier pour béton/briques [220x220x75mm]
099.142	Pg.415 Kit emergenza / Emergency Kit
024.324	Vetro di protezione / Protection glass / Schutzglas / Verre de protection

NEW 2416E



1,8 Kg

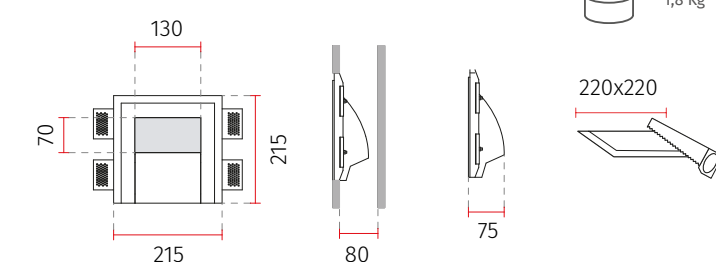

# INCASSO A PARETE

Wall recessed lighting  
Wand-Einbauleuchten  
Encastrés Muraux

CRISTALY<sup>®</sup>

made in Italy

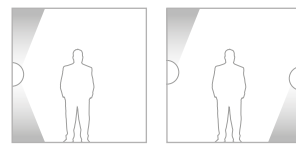

CASAMBI Pg.408

Art. 2618 - Private house - Caserta, Italy



Art. 2466B

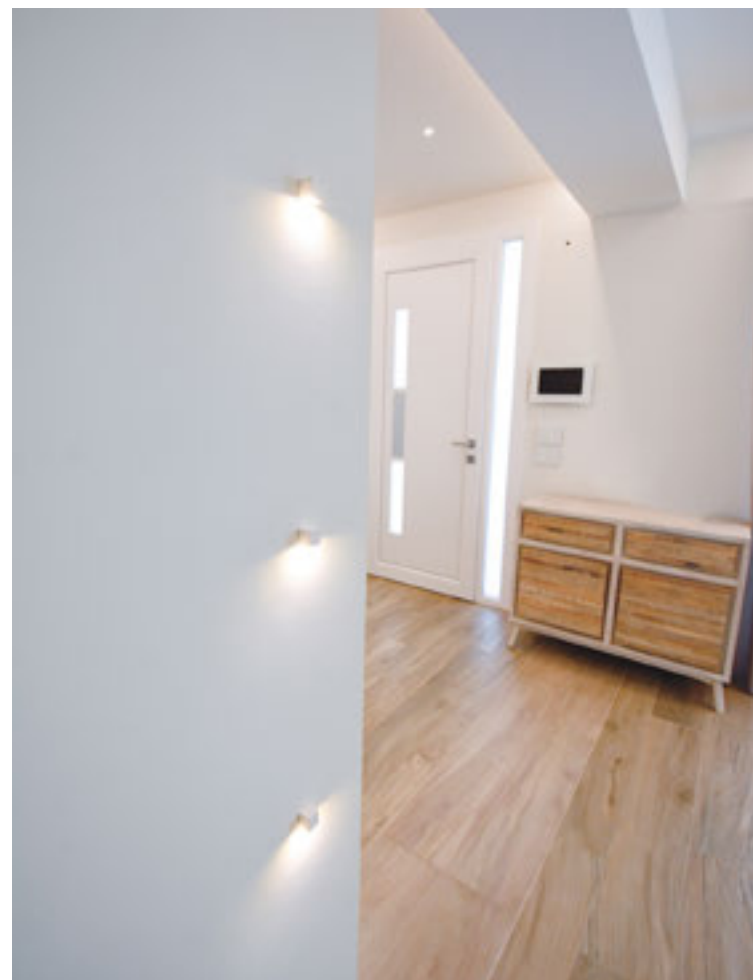

## DATI TECNICI / TECHNICAL DATA

2618-3008	LED 2x13W-700mA-3200lm-3000°K-CRI90
2618-2708	LED 2x13W-700mA-3050lm-2700°K-CRI90
2618-4008	LED 2x13W-700mA-3350lm-4000°K-CRI90
026.256	DRIVER ON/OFF min24.9W max35.7W 700mA
026.207	DRIVER DIM 0-10V 60.2W 700mA
026.206	DRIVER DIM PUSH/DALI 60.2W 700mA

## ACCESSORI / ACCESSORIES

023.495	Controcassa per muratura / Housing box for brickwork / Einbaugehäuse für Betonwand / Boîtier pour béton/briques [220x220x75mm]
099.142	Pg.415 Kit emergenza / Emergency Kit

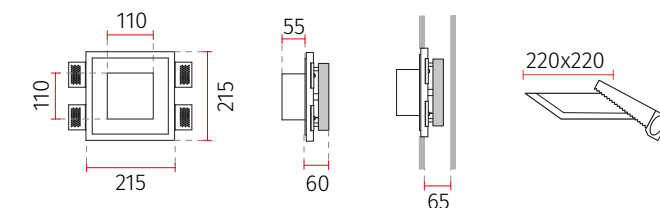

2618



## DATI TECNICI / TECHNICAL DATA

2619-3008	LED 2x13W-700mA-3200lm-3000°K-CRI90
2619-2708	LED 2x13W-700mA-3050lm-2700°K-CRI90
2619-4008	LED 2x13W-700mA-3350lm-4000°K-CRI90
026.256	DRIVER ON/OFF min24.9W max35.7W 700mA
026.207	DRIVER DIM 0-10V 60.2W 700mA
026.206	DRIVER DIM PUSH/DALI 60.2W 700mA

## ACCESSORI / ACCESSORIES

023.491	Controcassa per muratura / Housing box for brickwork / Einbaugehäuse für Betonwand / Boîtier pour béton/briques [205x405x75mm]
099.142	Pg.415 Kit emergenza / Emergency Kit

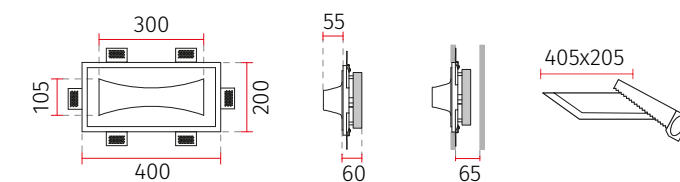

2619

## DATI TECNICI / TECHNICAL DATA

2466B-3000	LED 2W-24Vdc-200lm-3000°K-CRI90
2466B-2700	LED 2W-24Vdc-190lm-2700°K-CRI90
2466B-4000	LED 2W-24Vdc-210lm-4000°K-CRI90
026.258	DRIVER ON/OFF 12W 24V
026.259	DRIVER ON/OFF 36W 24V
026.260	DRIVER ON/OFF 60W 24V
026.219	DRIVER DIM PUSH/0-10V/DALI 21.6W 24V
026.209	DRIVER DIM PUSH/1-10V 60W 24V

## ACCESSORI / ACCESSORIES

023.450	Controcassa per muratura / Housing box for brickwork / Einbaugehäuse für Betonwand / Boîtier pour béton/briques [105x105x65mm]
099.142	Pg.415 Kit emergenza / Emergency Kit

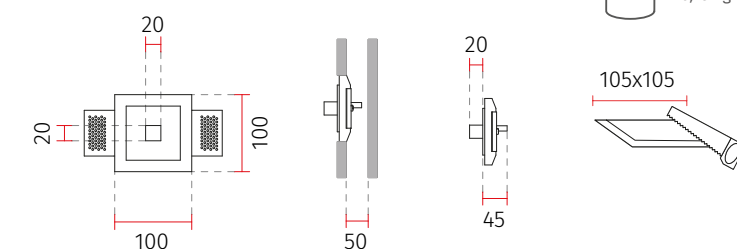

NEW 2466B

IT Misure espresse in mm, tolleranza +/- 1-2 mm. L'azienda si riserva la facoltà di apportare variazioni di dati caratteristici, materiali, design, stili, tonalità, senza alcun preavviso.  
EN Measures in mm, tolerance +/- 1/2 mm. The company reserves the right to carry out variations to technical details, materials, design, style, colors with no previous notice.

DE Die Masse sind in mm, mit einer Tolleranz von +/- 1-2 mm ausgedrückt. Die Firma behält sich das Recht vor ohne Voranmeldung Änderungen an den Werkstoffen, am Design, am Stil und an der Färbung vorzunehmen.  
FR Mesures en mm, tolérance +/- 1/2 mm. La société se réserve le droit de modifier sans préavis les détails techniques, les matériaux, le design, le style et les couleurs.

# TRASPARENZA DI LUCE

DESIGN MINIMALE  
MINIMAL DESIGN

FACILE DA INSTALLARE  
EASY INSTALLATION

ALTA RESISTENZA  
HIGH RESISTANCE

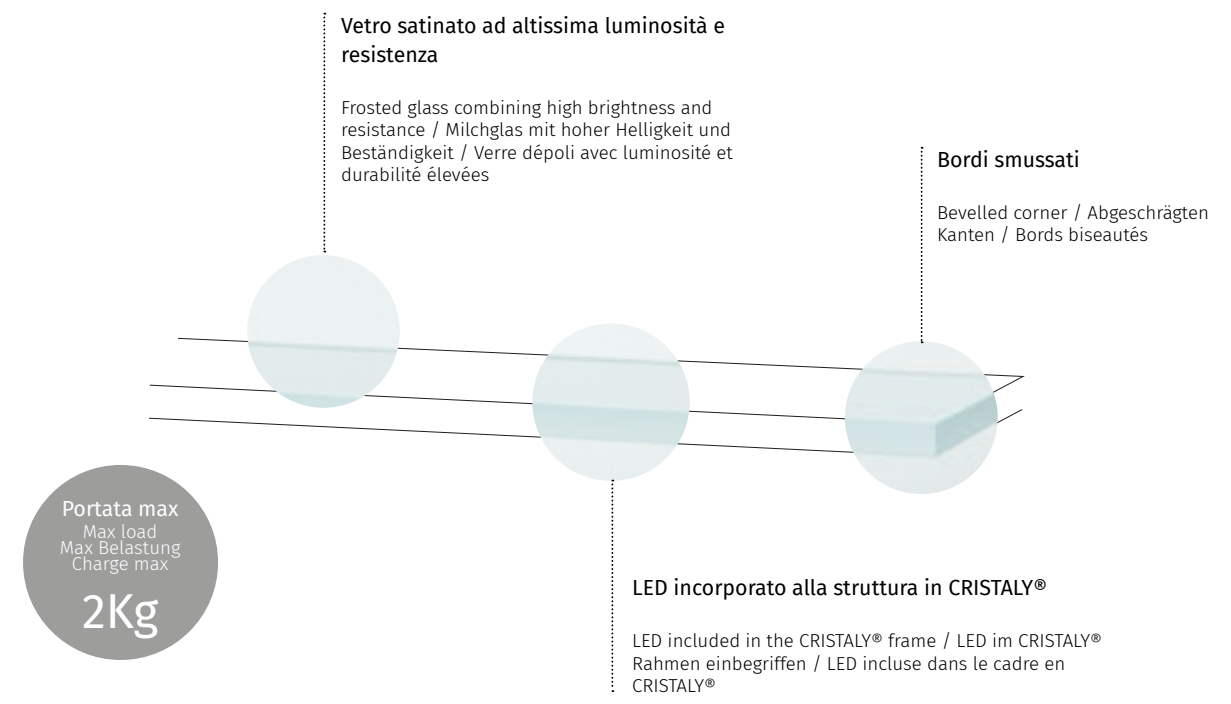

Grazie allo speciale sistema da incasso 9010 in totale assenza di supporti visibili, il prodotto si integra nella parete, combinando la semplicità del vetro con un effetto luminoso unico.

EN Thanks to the special 9010 recessed system, with no visible fixing support, the product integrates into the wall, combining the simplicity of the glass with a unique lighting effect.

DE Dank des speziellen Einbausystems 9010, ohne sichtbare Befestigungsunterstützung, integriert sich das Produkt in die Wand und kombiniert die Einfachheit des Glases mit einer einzigartigen Lichtwirkung.

FR Grâce au système spécial encastré 9010 en l'absence totale de supports visibles, le produit s'intègre dans le mur, alliant la simplicité du verre à un effet lumineux unique.



- A**  
**Vetro extra chiaro**  
Extra clear glass  
Extra klares Glas  
Verre extra clair
- B**  
**Superficie trasparente**  
Transparent surface  
Transparente Oberfläche  
Surface transparente
- C**  
**Bordi sabbati**  
Frosted glass edges  
Glas geschliffene Kanten  
Chants de verre dépoli
- D**  
**Superficie sabbata**  
Sandblasted glass  
Sandgestrahltes Glas  
Verre sablé

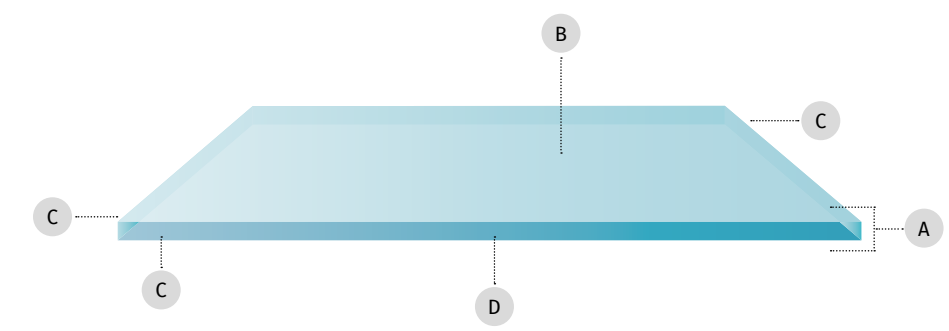

# INCASSO A PARETE

## Wall recessed lighting

### Wand-Einbauleuchten

### Encastrés Muraux

CRISTALY®

made in Italy



CASAMBI Pg.408

Art. 2484B



#### DATI TECNICI / TECHNICAL DATA

2484A-3004	LED 5.5W-24Vdc-500lm-3000°K-CRI85
2484A-2704	LED 5.5W-24Vdc-475lm-2700°K-CRI85
2484A-4004	LED 5.5W-24Vdc-530lm-4000°K-CRI85
026.258	DRIVER ON/OFF 12W 24V
026.259	DRIVER ON/OFF 36W 24V
026.260	DRIVER ON/OFF 60W 24V
026.261	DRIVER ON/OFF 150W 24V
026.262	DRIVER ON/OFF 240W 24V
026.219	DRIVER DIM PUSH/0-10V/DALI 21.6W 24V
026.209	DRIVER DIM PUSH/1-10V 60W 24V
026.190+026.261	DRIVER DIM PUSH/0-10V/DALI 150W 24V
026.190+026.262	DRIVER DIM PUSH/0-10V/DALI 240W 24V

#### ACCESSORI / ACCESSORIES

023.4003	Controcassa per muratura/Housing box for brickwork / Einbaugeschäuse für Betonwand / Boîtier pour béton/briques [405x145x80mm]
099.142	Pg.415 Kit emergenza / Emergency Kit

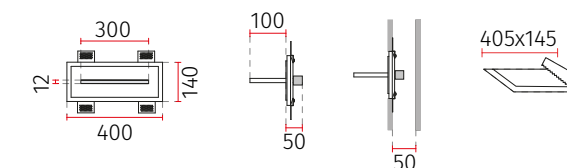

# 2484A



3,5 Kg

#### DATI TECNICI / TECHNICAL DATA

2484B-3004	LED 12W-24Vdc-1100lm-3000°K-CRI85
2484B-2704	LED 12W-24Vdc-1050lm-2700°K-CRI85
2484B-4004	LED 12W-24Vdc-1150lm-4000°K-CRI85
026.259	DRIVER ON/OFF 36W 24V
026.260	DRIVER ON/OFF 60W 24V
026.261	DRIVER ON/OFF 150W 24V
026.262	DRIVER ON/OFF 240W 24V
026.219	DRIVER DIM PUSH/0-10V/DALI 21.6W 24V
026.209	DRIVER DIM PUSH/1-10V 60W 24V
026.190+026.261	DRIVER DIM PUSH/0-10V/DALI 150W 24V
026.190+026.262	DRIVER DIM PUSH/0-10V/DALI 240W 24V

#### ACCESSORI / ACCESSORIES

023.4005	Controcassa per muratura/Housing box for brickwork / Einbaugeschäuse für Betonwand / Boîtier pour béton/briques [705x145x80mm]
099.142	Pg.415 Kit emergenza / Emergency Kit

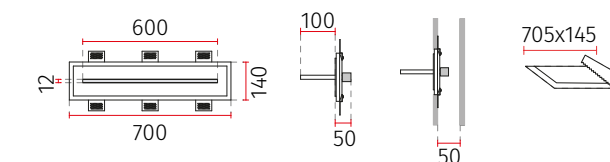

# 2484B



6,5 Kg

#### DATI TECNICI / TECHNICAL DATA

2484C-3004	LED 19W-24Vdc-1700lm-3000°K-CRI85
2484C-2704	LED 19W-24Vdc-1600lm-2700°K-CRI85
2484C-4004	LED 19W-24Vdc-1800lm-4000°K-CRI85
026.259	DRIVER ON/OFF 36W 24V
026.260	DRIVER ON/OFF 60W 24V
026.261	DRIVER ON/OFF 150W 24V
026.262	DRIVER ON/OFF 240W 24V
026.219	DRIVER DIM PUSH/0-10V/DALI 21.6W 24V
026.209	DRIVER DIM PUSH/1-10V 60W 24V
026.190+026.261	DRIVER DIM PUSH/0-10V/DALI 150W 24V
026.190+026.262	DRIVER DIM PUSH/0-10V/DALI 240W 24V

#### ACCESSORI / ACCESSORIES

023.4006	Controcassa per muratura/Housing box for brickwork / Einbaugeschäuse für Betonwand / Boîtier pour béton/briques [1005x145x65mm]
099.142	Pg.415 Kit emergenza / Emergency Kit

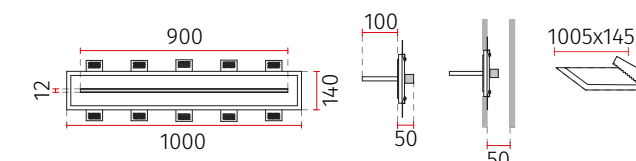

# 2484C



9,5 Kg

IT Misure espresse in mm, tolleranza +/- 1-2 mm. L'azienda si riserva la facoltà di apportare variazioni di dati caratteristici, materiali, design, stili, tonalità, senza alcun preavviso.  
EN Measures in mm, tolerance +/- 1/2 mm. The company reserves the right to carry out variations to technical details, materials, design, style, colors with no previous notice.

DE Die Masse sind in mm, mit einer Tolleranz von +/- 1-2 mm ausgedrückt. Die Firma behält sich das Recht vor ohne Voranmeldung Änderungen an den Werkstoffen, am Design, am Stil und an der Färbung vorzunehmen.  
FR Mesures en mm, tolérance +/- 1/2 mm. La société se réserve le droit de modifier sans préavis les détails techniques, les matériaux, le design, le style et les couleurs.

# L'ESSENZIALITÀ CHE ILLUMINA

DESIGN ESSENZIALE  
ESSENTIAL DESIGN

FACILE DA INSTALLARE  
EASY INSTALLATION

LUCE DIFFUSA  
DIFFUSED LIGHT

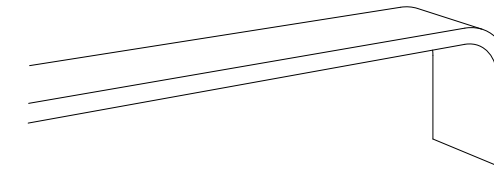

ALUMITE® verniciato RAL 9010 con angolo arrotondato

ALUMITE® painted RAL 9010 with rounded corner / ALUMITE® lackiert RAL 9010 mit abgerundeter Ecke / ALUMITE® peint RAL 9010 avec avec coins arrondis

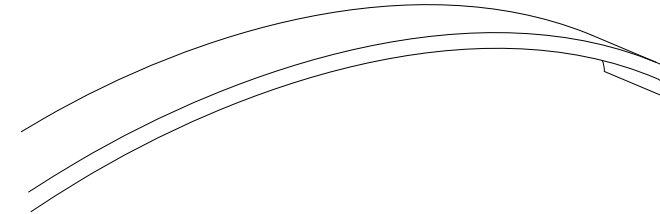

ALUMITE® verniciato RAL 9010 dalla forma arrotondata

ALUMITE® painted RAL 9010 rounded shape / ALUMITE® lackiert RAL 9010 mit abgerundeter Form / ALUMITE® peint RAL 9010 avec forme arrondie

9010 presenta una nuova forma di ALUMITE®: lampade da parete adattabili secondo le tue esigenze, disponibili in diverse lunghezze. Grazie allo speciale sistema da incasso 9010 in totale assenza di supporti visibili i prodotti si integrano nella parete. 9010 propone queste due lampade in diverse lunghezze, semplici da installare e adatte a tutti gli ambienti.

EN 9010 introduces new shapes with ALUMITE®, suitable for any interior need, available in different lengths. Thanks to the special recessed system by 9010 without any mounting support, the products are fully integrated into the wall. 9010 offers these lamps in different lengths, easy to install and suitable for any environment.

DE 9010 führt mit ALUMITE® neue Formen ein, die für jeden Innenbereich geeignet sind und in verschiedenen Längen erhältlich sind. Dank des speziellen Einbausystems von 9010 ohne Montagehilfe sind die Produkte vollständig in die Wand integriert. 9010 bietet diese Lampen in verschiedenen Längen an, einfach zu installieren und für jede Umgebung geeignet.

FR 9010 introduit de nouvelles formes avec ALUMITE®, adaptées à tous les besoins intérieurs, disponibles en différentes longueurs. Grâce au système spécial encastré 9010 sans aucun support de montage, les produits sont entièrement intégrés au mur. 9010 propose ses lampes dans différentes longueurs, faciles à installer et adaptées à tous les environnements.

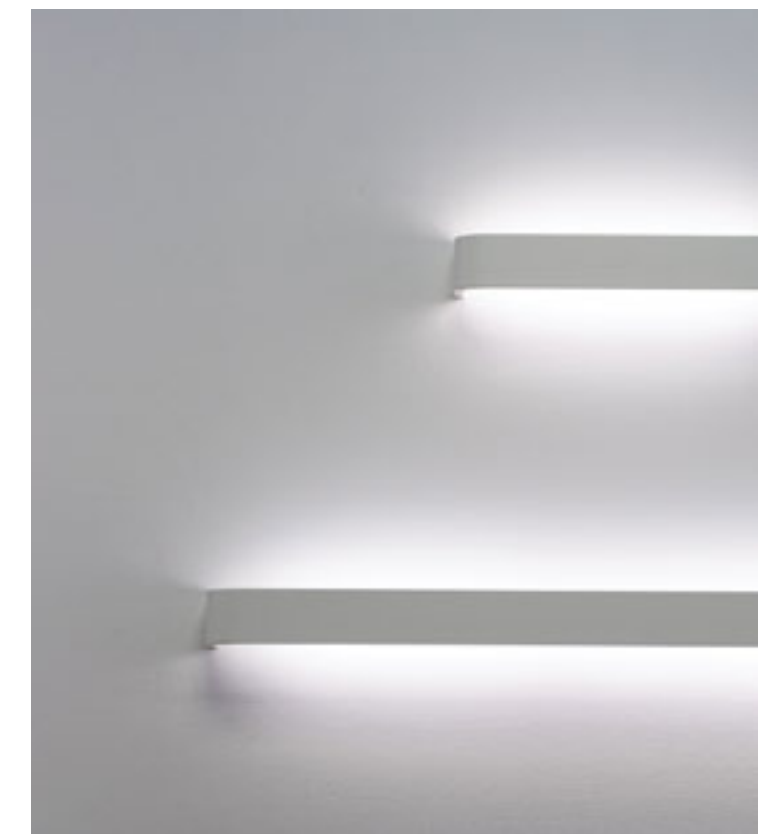

Sono disponibili diverse misure per soddisfare le varie esigenze

Various Measurements are available to meet different needs / Verschiedene Maßnahmen stehen zur Verfügung, um unterschiedliche Bedürfnisse zu erfüllen / Diverses mesures sont disponibles pour répondre aux différents besoins



# INCASSO A PARETE

## Wall recessed lighting

## Wand-Einbauleuchten

## Encastrés Muraux

ALUMITE®

made in Italy

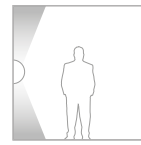

CASAMBI Pg.408

Art. 2485C - Private house - Varese, Italy  
Arch. Simonetta Franzini

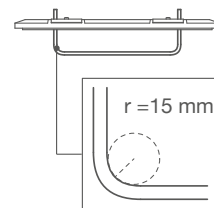
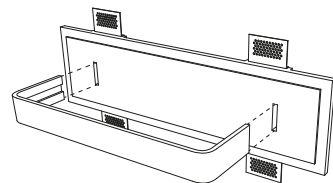

Raggio curvatura 15 mm  
Curvation radius 15 mm  
Kurvenradius 15 mm  
Rayon de courbe 15mm



Dettaglio STRIP LED e schermo  
Detail of LED Strip and cover  
Detail des LED-Streifens und der Abdeckung  
Détail du LED et de la couverture

### DATI TECNICI / TECHNICAL DATA

2485A-3003	LED 5.5W-24Vdc-600lm-3000°K-CRI90
2485A-2703	LED 5.5W-24Vdc-575lm-2700°K-CRI90
2485A-4003	LED 5.5W-24Vdc-630lm-4000°K-CRI90
026.258	DRIVER ON/OFF 12W 24V
026.259	DRIVER ON/OFF 36W 24V
026.260	DRIVER ON/OFF 60W 24V
026.261	DRIVER ON/OFF 150W 24V
026.262	DRIVER ON/OFF 240W 24V
026.219	DRIVER DIM PUSH/0-10V/DALI 21.6W 24V
026.209	DRIVER DIM PUSH/1-10V 60W 24V
026.190+026.261	DRIVER DIM PUSH/0-10V/DALI 150W 24V
026.190+026.262	DRIVER DIM PUSH/0-10V/DALI 240W 24V

### ACCESSORI / ACCESSORIES

023.4003	Controcassa per muratura/Housing box for brickwork / Einbaugehäuse für Betonwand / Boîtier pour béton/briques [405x145x80mm]
099.142	Pg.415 Kit emergenza / Emergency Kit

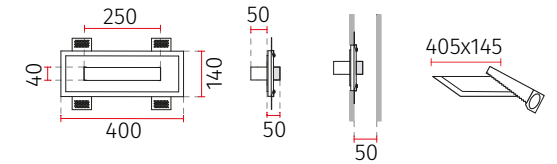

# 2485A



2,4 Kg

### DATI TECNICI / TECHNICAL DATA

2485B-3003	LED 10.5W-24Vdc-1200lm-3000°K-CRI90
2485B-2703	LED 10.5W-24Vdc-1150lm-2700°K-CRI90
2485B-4003	LED 10.5W-24Vdc-1250lm-4000°K-CRI90
026.258	DRIVER ON/OFF 12W 24V
026.259	DRIVER ON/OFF 36W 24V
026.260	DRIVER ON/OFF 60W 24V
026.261	DRIVER ON/OFF 150W 24V
026.262	DRIVER ON/OFF 240W 24V
026.219	DRIVER DIM PUSH/0-10V/DALI 21.6W 24V
026.209	DRIVER DIM PUSH/1-10V 60W 24V
026.190+026.261	DRIVER DIM PUSH/0-10V/DALI 150W 24V
026.190+026.262	DRIVER DIM PUSH/0-10V/DALI 240W 24V

### ACCESSORI / ACCESSORIES

023.4004	Controcassa per muratura/Housing box for brickwork / Einbaugehäuse für Betonwand / Boîtier pour béton/briques [555x145x85mm]
099.142	Pg.415 Kit emergenza / Emergency Kit

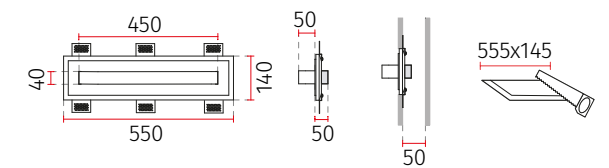

# 2485B



3,4 Kg

### DATI TECNICI / TECHNICAL DATA

2485C-3003	LED 14,5W-24Vdc-1650lm-3000°K-CRI90
2485C-2703	LED 14,5W-24Vdc-1600lm-2700°K-CRI90
2485C-4003	LED 14,5W-24Vdc-1700lm-4000°K-CRI90
026.259	DRIVER ON/OFF 36W 24V
026.260	DRIVER ON/OFF 60W 24V
026.261	DRIVER ON/OFF 150W 24V
026.262	DRIVER ON/OFF 240W 24V
026.219	DRIVER DIM PUSH/0-10V/DALI 21.6W 24V
026.209	DRIVER DIM PUSH/1-10V 60W 24V
026.190+026.261	DRIVER DIM PUSH/0-10V/DALI 150W 24V
026.190+026.262	DRIVER DIM PUSH/0-10V/DALI 240W 24V

### ACCESSORI / ACCESSORIES

023.4005	Controcassa per muratura/Housing box for brickwork / Einbaugehäuse für Betonwand / Boîtier pour béton/briques [705x145x80mm]
099.142	Pg.415 Kit emergenza / Emergency Kit

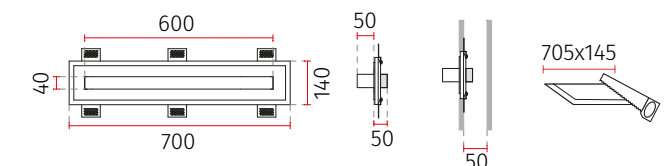

# 2485C



5,6 Kg

IT Misure espresse in mm, tolleranza +/- 1-2 mm. L'azienda si riserva la facoltà di apportare variazioni di dati caratteristici, materiali, design, stili, tonalità, senza alcun preavviso.  
EN Measures in mm, tolerance +/- 1/2 mm. The company reserves the right to carry out variations to technical details, materials, design, style, colors with no previous notice.

DE Die Masse sind in mm, mit einer Tolleranz von +/- 1-2 mm ausgedrückt. Die Firma behält sich das Recht vor ohne Voranmeldung Änderungen an den Werkstoffen, am Design, am Stil und an der Färbung vorzunehmen.  
FR Mesures en mm, tolérance +/- 1/2 mm. La société se réserve le droit de modifier sans préavis les détails techniques, les matériaux, le design, le style et les couleurs.

# INCASSO A PARETE

## Wall recessed lighting

## Wand-Einbauleuchten

## Encastrés Muraux

CRISTALY<sup>®</sup>  
ALUMITE<sup>®</sup> made in Italy



CASAMBI Pg.408

Art. 2486B / M900C - Rifugio Pranolz - Belluno, Italy

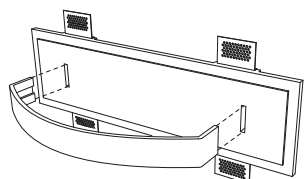
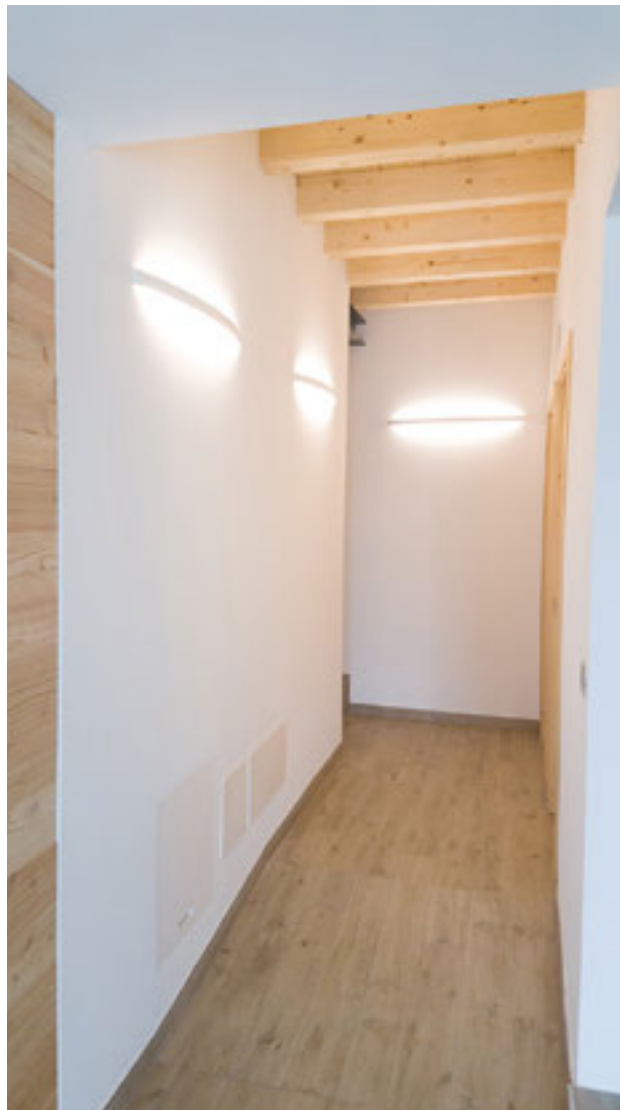

Dettaglio STRIP LED e schermo  
Detail of LED Strip and cover  
Detail des LED-Streifens und der Abdeckung  
Détail du LED et de la couverture

### DATI TECNICI / TECHNICAL DATA

2486A-3003	LED 8W-24Vdc-900lm-3000°K-CRI90
2486A-2703	LED 8W-24Vdc-850lm-2700°K-CRI90
2486A-4003	LED 8W-24Vdc-950lm-4000°K-CRI90
026.258	DRIVER ON/OFF 12W 24V
026.259	DRIVER ON/OFF 36W 24V
026.260	DRIVER ON/OFF 60W 24V
026.261	DRIVER ON/OFF 150W 24V
026.262	DRIVER ON/OFF 240W 24V
026.219	DRIVER DIM PUSH/0-10V/DALI 21.6W 24V
026.209	DRIVER DIM PUSH/1-10V 60W 24V
026.190+026.261	DRIVER DIM PUSH/0-10V/DALI 150W 24V
026.190+026.262	DRIVER DIM PUSH/0-10V/DALI 240W 24V

### ACCESSORI / ACCESSORIES

023.4003	Controcassa per muratura/Housing box for brickwork / Einbaugehäuse für Betonwand / Boîtier pour béton/briques [405x145x80mm]
099.142	Pg.415 Kit emergenza / Emergency Kit

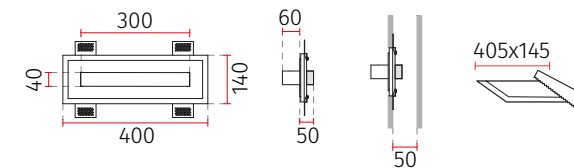

### DATI TECNICI / TECHNICAL DATA

2486B-3003	LED 16W-24Vdc-1800lm-3000°K-CRI90
2486B-2703	LED 16W-24Vdc-1700lm-2700°K-CRI90
2486B-4003	LED 16W-24Vdc-1900lm-4000°K-CRI90
026.259	DRIVER ON/OFF 36W 24V
026.260	DRIVER ON/OFF 60W 24V
026.261	DRIVER ON/OFF 150W 24V
026.262	DRIVER ON/OFF 240W 24V
026.219	DRIVER DIM PUSH/0-10V/DALI 21.6W 24V
026.209	DRIVER DIM PUSH/1-10V 60W 24V
026.190+026.261	DRIVER DIM PUSH/0-10V/DALI 150W 24V
026.190+026.262	DRIVER DIM PUSH/0-10V/DALI 240W 24V

### ACCESSORI / ACCESSORIES

023.4005	Controcassa per muratura/Housing box for brickwork / Einbaugehäuse für Betonwand / Boîtier pour béton/briques [705x145x80mm]
099.142	Pg.415 Kit emergenza / Emergency Kit

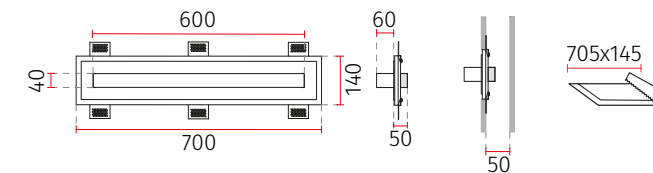

# 2486A

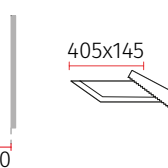

# 2486B

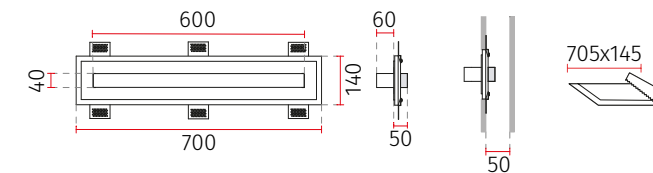

IT Misure espresse in mm, tolleranza +/- 1-2 mm. L'azienda si riserva la facoltà di apportare variazioni di dati caratteristici, materiali, design, stili, tonalità, senza alcun preavviso.  
EN Measures in mm, tolerance +/- 1/2 mm. The company reserves the right to carry out variations to technical details, materials, design, style, colors with no previous notice.

DE Die Masse sind in mm, mit einer Tolleranz von +/- 1-2 mm ausgedrückt. Die Firma behält sich das Recht vor ohne Voranmeldung Änderungen an den Werkstoffen, am Design, am Stil und an der Färbung vorzunehmen.  
FR Mesures en mm, tolérance +/- 1/2 mm. La société se réserve le droit de modifier sans préavis les détails techniques, les matériaux, le design, le style et les couleurs.



# INCASSO A PARETE

## Wall recessed lighting

## Wand-Einbauleuchten

## Encastrés Muraux

CRISTALY®  
ALUMITE®  
made in Italy



CASAMBI Pg.408

Art. 2486C

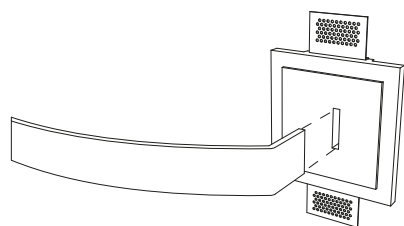

Dettaglio STRIP LED e schermo  
Detail of LED Strip and cover  
Detail des LED-Streifens und der Abdeckung  
Détail du LED et de la couverture

### DATI TECNICI / TECHNICAL DATA

2486D-3003	LED 32W-24Vdc-3600lm-3000°K-CRI90
2486D-2703	LED 32W-24Vdc-3450lm-2700°K-CRI90
2486D-4003	LED 32W-24Vdc-3800lm-4000°K-CRI90
026.259	DRIVER ON/OFF 36W 24V
026.260	DRIVER ON/OFF 60W 24V
026.261	DRIVER ON/OFF 150W 24V
026.262	DRIVER ON/OFF 240W 24V
026.209	DRIVER DIM PUSH/1-10V 60W 24V
026.190+026.261	DRIVER DIM PUSH/0-10V/DALI 150W 24V
026.190+026.262	DRIVER DIM PUSH/0-10V/DALI 240W 24V

### ACCESSORI / ACCESSORIES

2x023.478	Controcassa per muratura / Housing box for brickwork / Einbaugehäuse für Betonwand / Boîtier pour béton/briques [140x140x75mm]
099.142	Pg.415 Kit emergenza / Emergency Kit

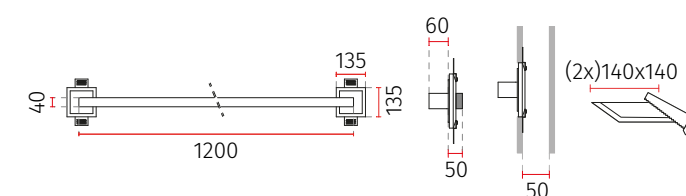

# 2486D

1,9 Kg

### DATI TECNICI / TECHNICAL DATA

2486E-3003	LED 39W-24Vdc-4500lm-3000°K-CRI90
2486E-2703	LED 39W-24Vdc-4300lm-2700°K-CRI90
2486E-4003	LED 39W-24Vdc-4700lm-4000°K-CRI90
026.259	DRIVER ON/OFF 36W 24V
026.260	DRIVER ON/OFF 60W 24V
026.261	DRIVER ON/OFF 150W 24V
026.262	DRIVER ON/OFF 240W 24V
026.209	DRIVER DIM PUSH/1-10V 60W 24V
026.190+026.261	DRIVER DIM PUSH/0-10V/DALI 150W 24V
026.190+026.262	DRIVER DIM PUSH/0-10V/DALI 240W 24V

### ACCESSORI / ACCESSORIES

2x023.478	Controcassa per muratura / Housing box for brickwork / Einbaugehäuse für Betonwand / Boîtier pour béton/briques [140x140x75mm]
099.142	Pg.415 Kit emergenza / Emergency Kit

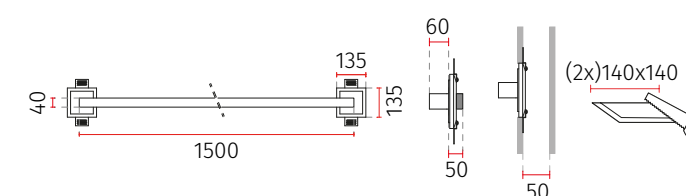

# 2486E

2,1 Kg

### DATI TECNICI / TECHNICAL DATA

2486F-3003	LED 52W-24Vdc-6000lm-3000°K-CRI90
2486F-2703	LED 52W-24Vdc-5700lm-2700°K-CRI90
2486F-4003	LED 52W-24Vdc-6300lm-4000°K-CRI90
026.260	DRIVER ON/OFF 60W 24V
026.261	DRIVER ON/OFF 150W 24V
026.262	DRIVER ON/OFF 240W 24V
026.209	DRIVER DIM PUSH/1-10V 60W 24V
026.190+026.261	DRIVER DIM PUSH/0-10V/DALI 150W 24V
026.190+026.262	DRIVER DIM PUSH/0-10V/DALI 240W 24V

### ACCESSORI / ACCESSORIES

2x023.478	Controcassa per muratura / Housing box for brickwork / Einbaugehäuse für Betonwand / Boîtier pour béton/briques [140x140x75mm]
099.142	Pg.415 Kit emergenza / Emergency Kit

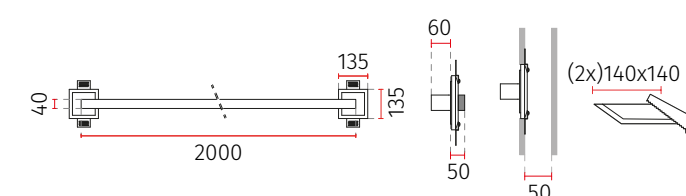

# 2486F

2,4 Kg

# 2486C



1,7 Kg

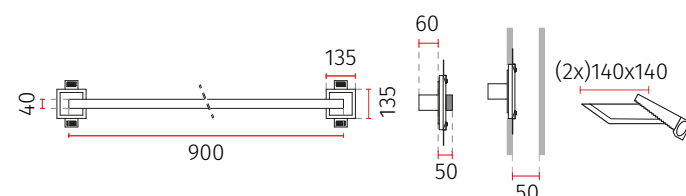

### DATI TECNICI / TECHNICAL DATA

2486C-3003	LED 24W-24Vdc-2700lm-3000°K-CRI90
2486C-2703	LED 24W-24Vdc-2600lm-2700°K-CRI90
2486C-4003	LED 24W-24Vdc-2850lm-4000°K-CRI90
026.259	DRIVER ON/OFF 36W 24V
026.260	DRIVER ON/OFF 60W 24V
026.261	DRIVER ON/OFF 150W 24V
026.262	DRIVER ON/OFF 240W 24V
026.209	DRIVER DIM PUSH/1-10V 60W 24V
026.190+026.261	DRIVER DIM PUSH/0-10V/DALI 150W 24V
026.190+026.262	DRIVER DIM PUSH/0-10V/DALI 240W 24V

### ACCESSORI / ACCESSORIES

2x023.478	Controcassa per muratura / Housing box for brickwork / Einbaugehäuse für Betonwand / Boîtier pour béton/briques [140x140x75mm]
099.142	Pg.415 Kit emergenza / Emergency Kit

IT Misure espresse in mm, tolleranza +/- 1-2 mm. L'azienda si riserva la facoltà di apportare variazioni di dati caratteristici, materiali, design, stili, tonalità, senza alcun preavviso.  
EN Measures in mm, tolerance +/- 1/2 mm. The company reserves the right to carry out variations to technical details, materials, design, style, colors with no previous notice.

DE Die Masse sind in mm, mit einer Tolleranz von +/- 1-2 mm ausgedrückt. Die Firma behält sich das Recht vor ohne Voranmeldung Änderungen an den Werkstoffen, am Design, am Stil und an der Färbung vorzunehmen.  
FR Mesures en mm, tolérance +/- 1/2 mm. La société se réserve le droit de modifier sans préavis les détails techniques, les matériaux, le design, le style et les couleurs.



## MINIMALISMO D'IMPATTO

**DUE SPORGENZE**  
TWO DEPTHS

**MINIMALE**  
MINIMAL

**ELEVATA RESA LUMINOSA**  
HIGH LIGHT OUTPUT

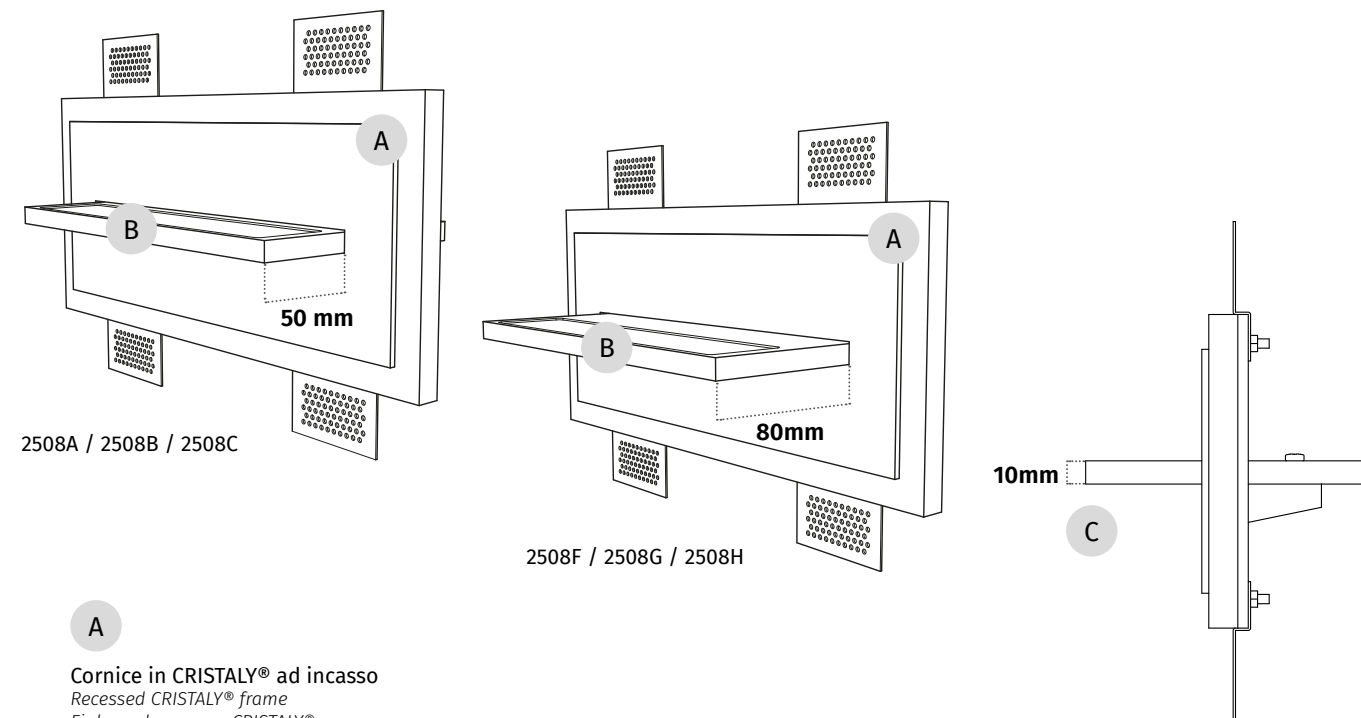

**A**

**Cornice in CRISTALY® ad incasso**  
Recessed CRISTALY® frame  
Einbaurahmen aus CRISTALY®  
Cadre encastré en CRISTALY®

**B**

**Speciale supporto ALUMITE® verniciato RAL 9010**  
Special ALUMITE® support painted RAL 9010  
Spezielle ALUMITE® Halterung lackiert RAL 9010  
Support spécial en ALUMITE® peint RAL 9010

**C**

**Spessore minimale e due misure di sporgenza**  
Minimal Thickness and two different depths  
Minimale Dicke und zwei verschiedene Tiefe  
Épaisseur minimale et deux mesures de saillie

9010 propone un connubio tra CRISTALY® ed ALUMITE® sviluppando una serie di articoli ad incasso dall'estetica minimale: una sottile ed elegante linea con un'elevata resa luminosa.

EN 9010 proposes a combination of CRISTALY® and ALUMITE® developing a series of recessed items with minimal aesthetics. This is a thin and elegant line with a high light output.

DE Bei 9010 entsteht aus der Verbindung zwischen CRISTALY® und ALUMITE® eine Reihe von Einbauleuchten mit minimalistischem Erscheinungsbild: eine schmale, elegante Linie mit hoher Lichtausbeute.

FR 9010 propose une association entre CRISTALY® et ALUMITE® en développant une série d'articles à encastrer à l'aspect minimaliste : une ligne élégante et fine avec une grande intensité lumineuse.



# INCASSO A PARETE

Wall recessed lighting  
Wand-Einbauleuchten  
Encastrés Muraux

CRISTALY®  
ALUMITE®

made in Italy



CASAMBI Pg.408

Art. 2508B



Standard RAL 9010 opaco - Su richiesta altri colori RAL (tempi di consegna da confermare)

EN Standard RAL 9010 matt - On request other RAL colours (delivery time to be confirmed)

DE Standard RAL 9010 matt - Auf Anfrage andere RAL Farben (Lieferzeit zu bestätigen)

FR Standard RAL 9010 mat - Sur demande autres couleurs RAL (délai de livraison à confirmer)

IT Misure espresse in mm, tolleranza +/- 1-2 mm. L'azienda si riserva la facoltà di apportare variazioni di dati caratteristici, materiali, design, stili, tonalità, senza alcun preavviso.  
EN Measures in mm, tolerance +/- 1/2 mm. The company reserves the right to carry out variations to technical details, materials, design, style, colors with no previous notice.

## DATI TECNICI / TECHNICAL DATA

2508A-30135	LED 8.5W-700mA-1250lm-3000°K-CRI85
2508A-27135	LED 8.5W-700mA-1200lm-2700°K-CRI85
2508A-40135	LED 8.5W-700mA-1300lm-4000°K-CRI85
026.173	DRIVER ON/OFF min7W max19.6W 700mA
026.256	DRIVER ON/OFF min24.9W max35.7W 700mA
026.219	DRIVER DIM PUSH/0-10V/DALI 19.6W 700mA
026.207	DRIVER DIM 0-10V 60.2W 700mA
026.206	DRIVER DIM PUSH/DALI 60.2W 700mA

## ACCESSORI / ACCESSORIES

023.489	Controcassa per muratura / Housing box for brickwork / Einbaugehäuse für Betonwand / Boîtier pour béton/briques [210x140x85mm]
099.142	Pg.415 Kit emergenza / Emergency Kit

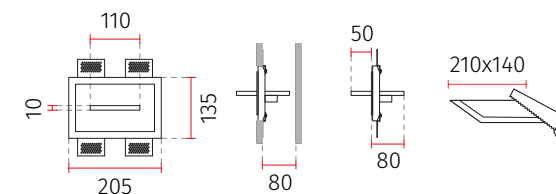

## DATI TECNICI / TECHNICAL DATA

2508B-30135	LED 17W-700mA-2500lm-3000°K-CRI85
2508B-27135	LED 17W-700mA-2400lm-2700°K-CRI85
2508B-40135	LED 17W-700mA-2600lm-4000°K-CRI85
026.255	DRIVER ON/OFF min11.9W max18.2W 700mA
026.256	DRIVER ON/OFF min24.9W max35.7W 700mA
026.219	DRIVER DIM PUSH/0-10V/DALI 19.6W 700mA
026.207	DRIVER DIM 0-10V 60.2W 700mA
026.206	DRIVER DIM PUSH/DALI 60.2W 700mA

## ACCESSORI / ACCESSORIES

023.4013	Controcassa per muratura / Housing box for brickwork / Einbaugehäuse für Betonwand / Boîtier pour béton/briques [315x145x85mm]
099.142	Pg.415 Kit emergenza / Emergency Kit

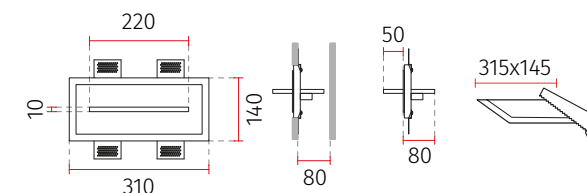

## DATI TECNICI / TECHNICAL DATA

2508C-30135	LED 34W-700mA-5000lm-3000°K-CRI85
2508C-27135	LED 34W-700mA-4750lm-2700°K-CRI85
2508C-40135	LED 34W-700mA-5250lm-4000°K-CRI85
026.256	DRIVER ON/OFF min24.9W max35.7W 700mA
026.207	DRIVER DIM 0-10V 60.2W 700mA
026.206	DRIVER DIM PUSH/DALI 60.2W 700mA

## ACCESSORI / ACCESSORIES

023.4004	Controcassa per muratura / Housing box for brickwork / Einbaugehäuse für Betonwand / Boîtier pour béton/briques [555x145x85mm]
099.142	Pg.415 Kit emergenza / Emergency Kit

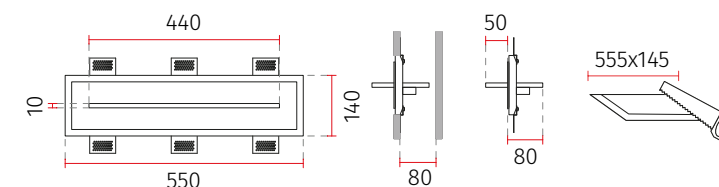

DE Die Masse sind in mm, mit einer Tolleranz von +/- 1-2 mm ausgedrückt, Die Firma behält sich das Recht vor ohne Voranmeldung Änderungen an den Werkstoffen, am Design, am Stil und an der Färbung vorzunehmen.  
FR Mesures en mm, tolérance +/- 1/2 mm. La société se réserve le droit de modifier sans préavis les détails techniques, les matériaux, le design, le style et les couleurs.

NEW 2508A



NEW 2508B



NEW 2508C



# INCASSO A PARETE

Wall recessed lighting  
Wand-Einbauleuchten  
Encastrés Muraux

CRISTALY®  
ALUMITE®

made in Italy

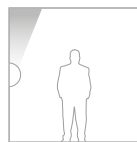

CASAMBI Pg.408

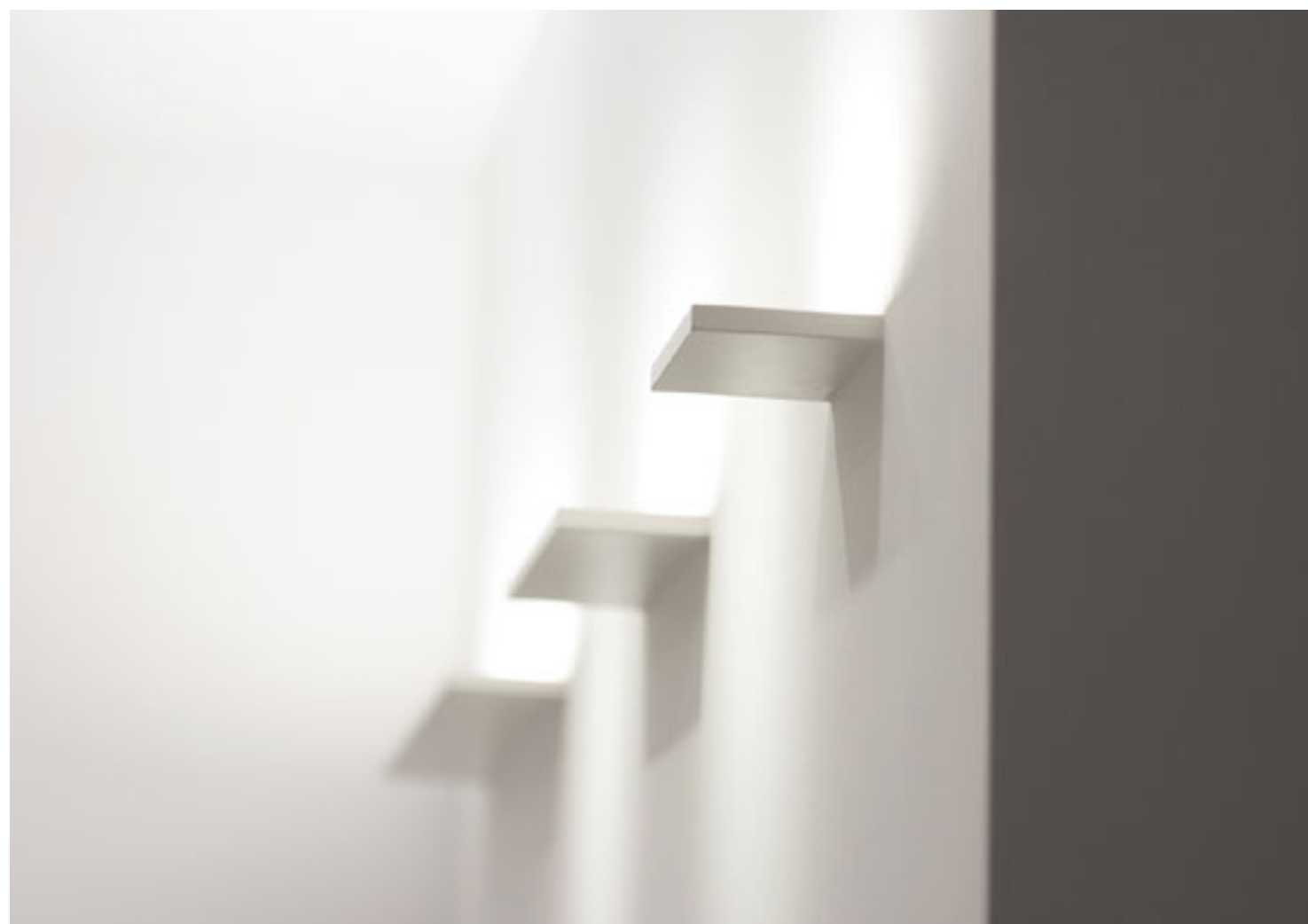

Standard RAL 9010 opaco - Su richiesta altri colori RAL (tempi di consegna da confermare)

EN Standard RAL 9010 matt - On request other RAL colours (delivery time to be confirmed)

DE Standard RAL 9010 matt - Auf Anfrage andere RAL Farben (Lieferzeit zu bestätigen)

FR Standard RAL 9010 mat - Sur demande autres couleurs RAL (délai de livraison à confirmer)

IT Misure espresse in mm, tolleranza +/- 1-2 mm. L'azienda si riserva la facoltà di apportare variazioni di dati caratteristici, materiali, design, stili, tonalità, senza alcun preavviso.  
EN Measures in mm, tolerance +/- 1/2 mm. The company reserves the right to carry out variations to technical details, materials, design, style, colors with no previous notice.

## DATI TECNICI / TECHNICAL DATA

2508F-30135	LED 8.5W-700mA-1250lm-3000°K-CRI85
2508F-27135	LED 8.5W-700mA-1200lm-2700°K-CRI85
2508F-40135	LED 8.5W-700mA-1300lm-4000°K-CRI85
026.173	DRIVER ON/OFF min7W max19.6W 700mA
026.256	DRIVER ON/OFF min24.9W max35.7W 700mA
026.219	DRIVER DIM PUSH/0-10V/DALI 19.6W 700mA
026.207	DRIVER DIM 0-10V 60.2W 700mA
026.206	DRIVER DIM PUSH/DALI 60.2W 700mA

## ACCESSORI / ACCESSORIES

023.489	Controcassa per muratura / Housing box for brickwork / Einbaugehäuse für Betonwand / Boîtier pour béton/briques [210x140x85mm]
099.142	Pg.415 Kit emergenza / Emergency Kit

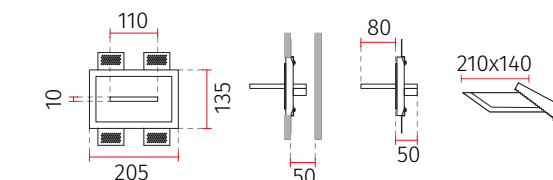

NEW 2508F



## DATI TECNICI / TECHNICAL DATA

2508G-30135	LED 17W-700mA-2500lm-3000°K-CRI85
2508G-27135	LED 17W-700mA-2400lm-2700°K-CRI85
2508G-40135	LED 17W-700mA-2600lm-4000°K-CRI85
026.255	DRIVER ON/OFF min11.9W max18.2W 700mA
026.256	DRIVER ON/OFF min24.9W max35.7W 700mA
026.219	DRIVER DIM PUSH/0-10V/DALI 19.6W 700mA
026.207	DRIVER DIM 0-10V 60.2W 700mA
026.206	DRIVER DIM PUSH/DALI 60.2W 700mA

## ACCESSORI / ACCESSORIES

023.4013	Controcassa per muratura / Housing box for brickwork / Einbaugehäuse für Betonwand / Boîtier pour béton/briques [315x145x85mm]
099.142	Pg.415 Kit emergenza / Emergency Kit

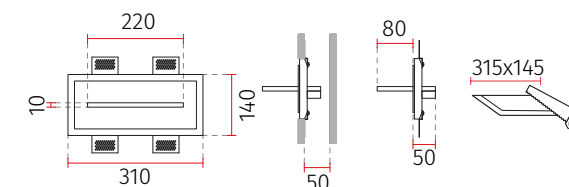

NEW 2508G



## DATI TECNICI / TECHNICAL DATA

2508H-30135	LED 34W-700mA-5000lm-3000°K-CRI85
2508H-27135	LED 34W-700mA-4750lm-2700°K-CRI85
2508H-40135	LED 34W-700mA-5250lm-4000°K-CRI85
026.256	DRIVER ON/OFF min24.9W max35.7W 700mA
026.207	DRIVER DIM 0-10V 60.2W 700mA
026.206	DRIVER DIM PUSH/DALI 60.2W 700mA

## ACCESSORI / ACCESSORIES

023.4004	Controcassa per muratura / Housing box for brickwork / Einbaugehäuse für Betonwand / Boîtier pour béton/briques [555x145x85mm]
099.142	Pg.415 Kit emergenza / Emergency Kit

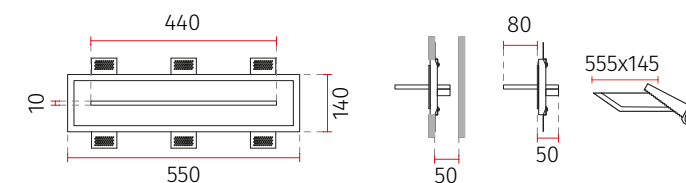













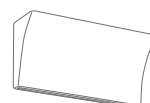



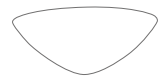
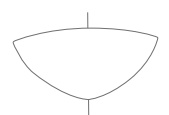
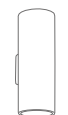
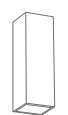



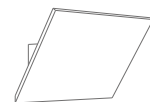
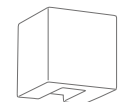
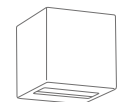

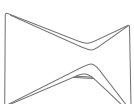

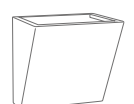
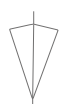

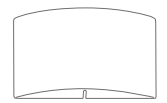
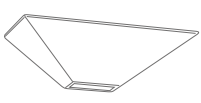
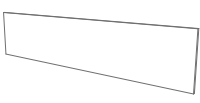
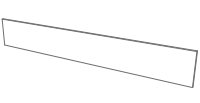
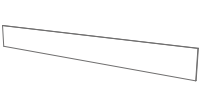
NEW 2508H

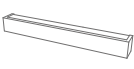
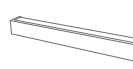

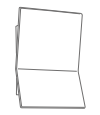
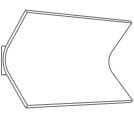
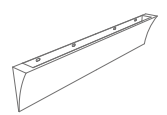
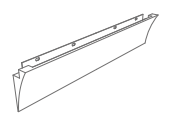
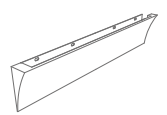
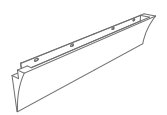
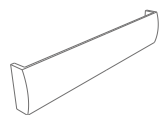
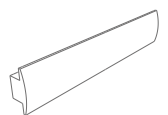
DE Die Masse sind in mm, mit einer Tolleranz von +/- 1-2 mm ausgedrückt, Die Firma behält sich das Recht vor ohne Voranmeldung Änderungen an den Werkstoffen, am Design, am Stil und an der Färbung vorzunehmen.  
FR Mesures en mm, tolérance +/- 1/2 mm. La société se réserve le droit de modifier sans préavis les détails techniques, les matériaux, le design, le style et les couleurs.

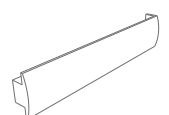
# APPARECCHI A PARETE

Wall lighting  
Wandleuchten  
Appliques

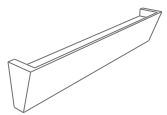
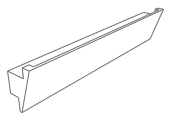
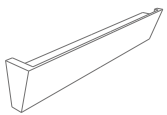
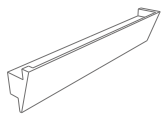
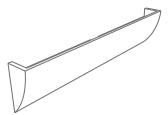
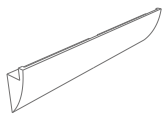
					
2012 p.61	2013 p.61	2014 p.61	2018 p.63	2019 p.63	2020 p.63
					
2139 p.65	7958 p.65	2184 p.67	8418 p.67	2293 p.69	8342 p.69
					
2304 p.71	<b>NEW</b> 2304B p.71	<b>NEW</b> 2509 p.71	2336 p.73	2336B p.73	<b>NEW</b> 2511 p.73
					
2388 p.77	<b>NEW</b> 2496 p.77	2601A p.77	2396 p.79	2602A p.79	2340 p.81
					
2398 p.81	2419A p.81	2421B p.84	2421C p.85	2421D p.85	2422B p.87
					
2423B p.87	2427B p.89	2429B p.89	<b>NEW</b> 2438 p.91	2474 p.91	<b>NEW</b> 2497 p.91
					
2443A p.95	2443B p.95	2443C p.95	2443D p.95	<b>NEW</b> 2630A p.97	<b>NEW</b> 2630B p.97
					
<b>NEW</b> 2630C p.97	<b>NEW</b> 2630D p.97	<b>NEW</b> 2632A p.99	<b>NEW</b> 2632B p.99	<b>NEW</b> 2632C p.99	<b>NEW</b> 2632D p.99
					
<b>NEW</b> 2634A p.101	<b>NEW</b> 2634B p.101	<b>NEW</b> 2634C p.101	<b>NEW</b> 2634D p.101	<b>NEW</b> 2635A p.103	<b>NEW</b> 2635B p.103

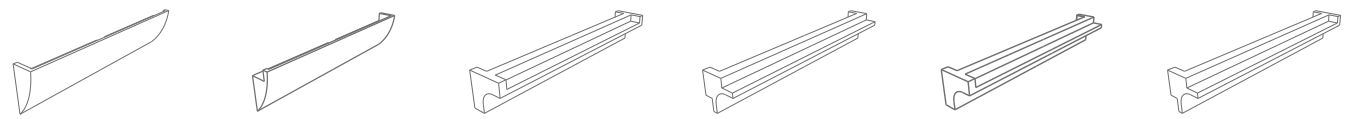

**NEW 2635C** p.103 **NEW 2635D** p.103 **NEW 2636A** p.105 **NEW 2636B** p.105 **NEW 2636C** p.105 **NEW 2636D** p.105



2452 p.107 2453 p.107 2546 p.107 2547 p.107 2455 p.109 2457 p.109

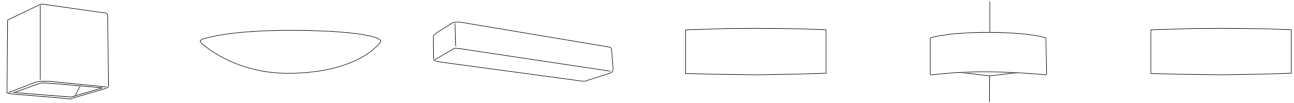

2495 p.109 2456 p.111 2458 p.111 2483A p.113 2483B p.113 2489A p.113

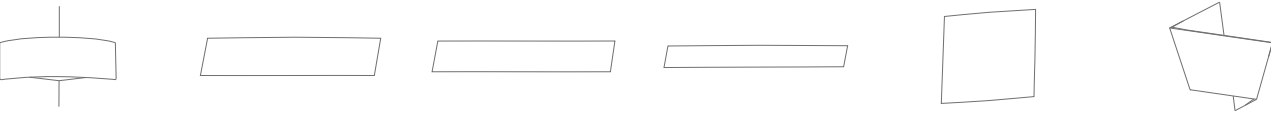

2489B p.113 2493A p.115 2493B p.115 2493C p.115 2493D p.115 **NEW 2498** p.116



**NEW 2500** p.117 **NEW 2503** p.117 **NEW 2504** p.117 **NEW 2516A** p.120 **NEW 2516C** p.120 **NEW 2516D** p.120



**NEW 2516F** p.121 **NEW 2516M** p.121 **NEW 2516Q** p.121 2536 p.125 2537 p.125 2541 p.125



2603A p.127 2603B p.127 2604B p.127 2608B p.127 2613B p.129 2614B p.129

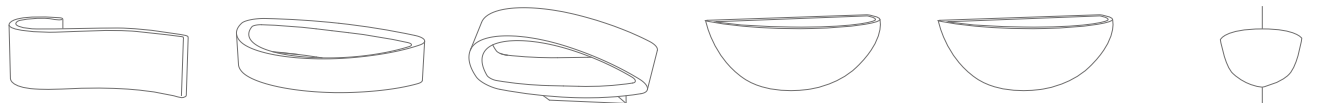

2615A p.129 2623C p.131 2623D p.131 7156 p.133 7157 p.133 7305 p.133



7310 p.133 7576 p.135 7577 p.135 7578 p.135 7946 p.137 7949 p.137



8215 p.137 8259 p.137 8042 p.139 8056 p.139 8144 p.139 8216 p.141

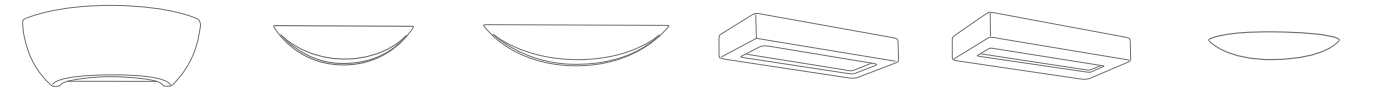

8254 p.141 8235 p.143 8411 p.143 8284 p.145 8382 p.145 8336 p.147



8337 p.147 8338 p.147 8428 p.149 9207 p.149 8429 p.151 8430 p.151

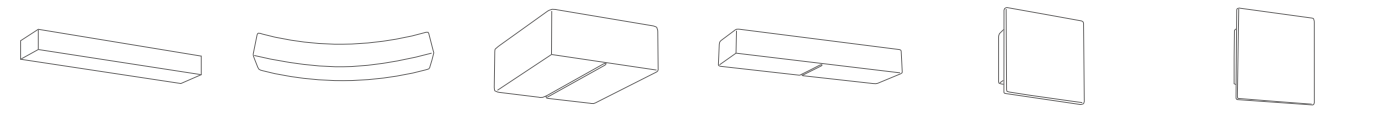

8431 p.151 8285 p.151 8459 p.153 8481 p.153 8672 p.155 8672B p.155



8673 p.155 8673B p.155 8759 p.157 8760 p.157

# A PARETE

Wall lighting  
Wandleuchten  
Appliques

CERAMICA 9200

made in Italy



Art. 2012 - Private house - Lucca, Italy



DATI TECNICI / TECHNICAL DATA	
2012-52	G9 60W-240V L100mm
2012-3057	LED 9W-220-240V-1350lm-3000°K-CRI85
2012-2757	LED 9W-220-240V-1300lm-2700°K-CRI85
2012-4057	LED 9W-220-240V-1400lm-4000°K-CRI85
2012-3057T	DIM LED* 9W-220-240V-1350lm-3000°K-CRI85
2012-2757T	DIM LED* 9W-220-240V-1300lm-2700°K-CRI85
2012-4057T	DIM LED* 9W-220-240V-1400lm-4000°K-CRI85

\* Alimentatore dimmerabile a taglio di fase / Dimmable phase cut power supply / Dimmbare Phasenanschnitt-Betriebsgerät / Alimentation dimmable à coupure de phase

2012



0,9 Kg

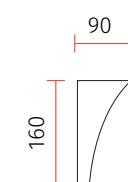
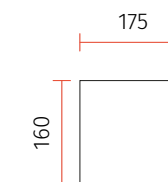

DATI TECNICI / TECHNICAL DATA	
2013-52	G9 60W-240V L90mm
2013-3056	LED 6W-220-240V-900lm-3000°K-CRI85
2013-2756	LED 6W-220-240V-850lm-2700°K-CRI85
2013-4056	LED 6W-220-240V-950lm-4000°K-CRI85
2013-3056T	DIM LED* 6W-220-240V-900lm-3000°K-CRI85
2013-2756T	DIM LED* 6W-220-240V-850lm-2700°K-CRI85
2013-4056T	DIM LED* 6W-220-240V-950lm-4000°K-CRI85

\* Alimentatore dimmerabile a taglio di fase / Dimmable phase cut power supply / Dimmbare Phasenanschnitt-Betriebsgerät / Alimentation dimmable à coupure de phase

2013



0,55 Kg

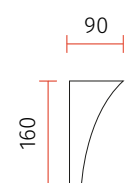
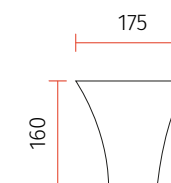

DATI TECNICI / TECHNICAL DATA	
2014-52	G9 2X60W-240V L90mm
2014-3060	LED 18W-220-240V-2700lm-3000°K-CRI85
2014-2760	LED 18W-220-240V-2550lm-2700°K-CRI85
2014-4060	LED 18W-220-240V-2850lm-4000°K-CRI85

2014



1,65 Kg

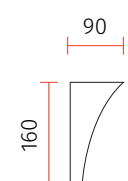
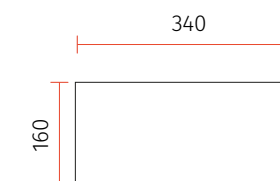

IT Misure espresse in mm, tolleranza +/- 1-2 mm. L'azienda si riserva la facoltà di apportare variazioni di dati caratteristici, materiali, design, stili, tonalità, senza alcun preavviso.  
EN Measures in mm, tolerance +/- 1/2 mm. The company reserves the right to carry out variations to technical details, materials, design, style, colors with no previous notice.

DE Die Masse sind in mm, mit einer Tolleranz von +/- 1-2 mm ausgedrückt, Die Firma behält sich das Recht vor ohne Voranmeldung Änderungen an den Werkstoffen, am Design, am Stil und an der Färbung vorzunehmen.  
FR Mesures en mm, tolérance +/- 1/2 mm. La société se réserve le droit de modifier sans préavis les détails techniques, les matériaux, le design, le style et les couleurs.

# A PARETE

## Wall lighting

## Wandleuchten

## Appliques

CERAMICA 9000

made in Italy



Art. 2020 - Private house - Torino, Italy



Diffusore in vetro  
Glass diffuser  
Glasabdeckung  
Diffuseur en verre



### DATI TECNICI / TECHNICAL DATA

2018-52	G9 60W-240V L 100mm
2018-3057	LED 9W-220-240V-1350lm-3000°K-CRI85
2018-2757	LED 9W-220-240V-1300lm-2700°K-CRI85
2018-4057	LED 9W-220-240V-1400lm-4000°K-CRI85
2018-3057T	DIM LED* 9W-220-240V-1350lm-3000°K-CRI85
2018-2757T	DIM LED* 9W-220-240V-1300lm-2700°K-CRI85
2018-4057T	DIM LED* 9W-220-240V-1400lm-4000°K-CRI85

\* Alimentatore dimmerabile a taglio di fase / Dimmable phase cut power supply /  
Dimmbare Phasenanschnitt-Betriebsgerät / Alimentation dimmable à coupure de phase

2018

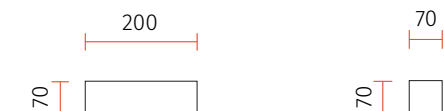

### DATI TECNICI / TECHNICAL DATA

2019-52	G9 2X60W-240V L 100mm
2019-3060	LED 18W-220-240V-2700lm-3000°K-CRI85
2019-2760	LED 18W-220-240V-2550lm-2700°K-CRI85
2019-4060	LED 18W-220-240V-2850lm-4000°K-CRI85
2019-3060T	DIM LED* 18W-220-240V-2700lm-3000°K-CRI85
2019-2760T	DIM LED* 18W-220-240V-2550lm-2700°K-CRI85
2019-4060T	DIM LED* 18W-220-240V-2850lm-4000°K-CRI85

\* Alimentatore dimmerabile a taglio di fase / Dimmable phase cut power supply /  
Dimmbare Phasenanschnitt-Betriebsgerät / Alimentation dimmable à coupure de phase

2019

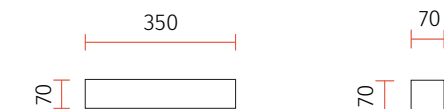

### DATI TECNICI / TECHNICAL DATA

2020-52	G9 2X60W-240V L 100mm
2020-3061	LED 24W-220-240V-3600lm-3000°K-CRI85
2020-2761	LED 24W-220-240V-3400lm-2700°K-CRI85
2020-4061	LED 24W-220-240V-3800lm-4000°K-CRI85
2020-3061T	DIM LED* 24W-220-240V-3600lm-3000°K-CRI85
2020-2761T	DIM LED* 24W-220-240V-3400lm-2700°K-CRI85
2020-4061T	DIM LED* 24W-220-240V-3800lm-4000°K-CRI85

\* Alimentatore dimmerabile a taglio di fase / Dimmable phase cut power supply /  
Dimmbare Phasenanschnitt-Betriebsgerät / Alimentation dimmable à coupure de phase

2020



IT Misure espresse in mm, tolleranza +/- 1-2 mm. L'azienda si riserva la facoltà di apportare variazioni di dati caratteristici, materiali, design, stili, tonalità, senza alcun preavviso.  
EN Measures in mm, tollerance +/- 1/2 mm. The company reserves the right to carry out variations to technical details, materials, design, style, colors with no previous notice.

DE Die Masse sind in mm, mit einer Tolleranz von +/- 1-2 mm ausgedrückt, Die Firma behält sich das Recht vor ohne Voranmeldung Änderungen an den Werkstoffen, am Design, am Stil und an der Färbung vorzunehmen.  
FR Mesures en mm, tolérance +/- 1/2 mm. La société se réserve le droit de modifier sans préavis les détails techniques, les matériaux, le design, le style et les couleurs.



**A PARETE**  
Wall lighting  
Wandleuchten  
Appliques

CERAMICA 1010

made in Italy

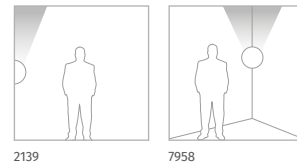

Art. 2139



Art. 7958



**DATI TECNICI / TECHNICAL DATA**

2139-41	E27 52W-240V L 110mm
2139-51	R7s 78mm 120W-240V
2139-57	R7s 118mm MAX 20W-220-240V
2139-3052	LED 12W-220-240V-1800lm-3000°K-CRI85
2139-2752	LED 12W-220-240V-1700lm-2700°K-CRI85
2139-4052	LED 12W-220-240V-1900lm-4000°K-CRI85
2139-3052T	DIM LED* 12W-220-240V-1800lm-3000°K-CRI85
2139-2752T	DIM LED* 12W-220-240V-1700lm-2700°K-CRI85
2139-4052T	DIM LED* 12W-220-240V-1900lm-4000°K-CRI85

\* Alimentatore dimmerabile a taglio di fase / Dimmable phase cut power supply /  
Dimmbare Phasenanschnitt-Betriebsgerät / Alimentation dimmable à coupure de phase

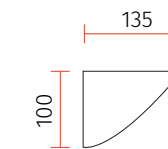
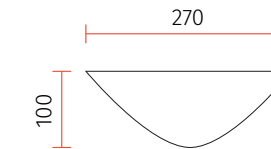

**7958**

**DATI TECNICI / TECHNICAL DATA**

7958-42	E27 52W-240V L 115mm
7958-3064	LED 12W-220-240V-1800lm-3000°K-CRI85
7958-2764	LED 12W-220-240V-1700lm-2700°K-CRI85
7958-4064	LED 12W-220-240V-1900lm-4000°K-CRI85
7958-3064T	DIM LED* 12W-220-240V-1800lm-3000°K-CRI85
7958-2764T	DIM LED* 12W-220-240V-1700lm-2700°K-CRI85
7958-4064T	DIM LED* 12W-220-240V-1900lm-4000°K-CRI85

\* Alimentatore dimmerabile a taglio di fase / Dimmable phase cut power supply /  
Dimmbare Phasenanschnitt-Betriebsgerät / Alimentation dimmable à coupure de phase

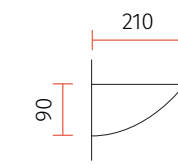
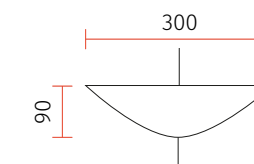

IT Misure espresse in mm, tolleranza +/- 1-2 mm. L'azienda si riserva la facoltà di apportare variazioni di dati caratteristici, materiali, design, stili, tonalità, senza alcun preavviso.  
EN Measures in mm, tolerance +/- 1/2 mm. The company reserves the right to carry out variations to technical details, materials, design, style, colors with no previous notice.

DE Die Masse sind in mm, mit einer Tolleranz von +/- 1-2 mm ausgedrückt, Die Firma behält sich das Recht vor ohne Voranmeldung Änderungen an den Werkstoffen, am Design, am Stil und an der Färbung vorzunehmen.  
FR Mesures en mm, tolérance +/- 1/2 mm. La société se réserve le droit de modifier sans préavis les détails techniques, les matériaux, le design, le style et les couleurs.



**A PARETE**  
Wall lighting  
Wandleuchten  
Appliques

CERAMICA 9000

made in Italy



**DATI TECNICI / TECHNICAL DATA**

2184-35	GU10 Ø50 MAX 2x50W-240V L 90mm
2184-54	G9 2X33W-240V L 75mm



**2184**

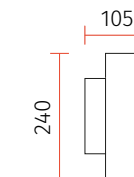
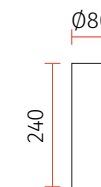

Art. 8418 - Private house - Pescara, Italy



**2184**

FINITURE SU RICHIESTA / FINISHES ON DEMAND  
OBERFLÄCHENVERARBEITUNGEN AUF NACHFRAGE / FINITIONS SUR DEMANDE:



390  
CORTEN



391  
OSSIDO  
OXIDE

**DATI TECNICI / TECHNICAL DATA**

8418-35	GU10 Ø50 MAX 2x50W-240V L 70mm
8418-54	G9 2X33W-240V L 70mm

**8418**

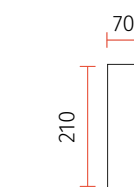
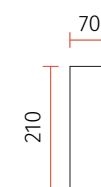

**8418**

FINITURE SU RICHIESTA / FINISHES ON DEMAND  
OBERFLÄCHENVERARBEITUNGEN AUF NACHFRAGE / FINITIONS SUR DEMANDE:



380  
PIETRA MARRONE  
BROWN STONE  
BRAUNER  
PIERRE BRUNE



381  
PIETRA GRIGIA  
GREY STONE  
GRAUER STEIN  
PIERRE GRISE



382  
PIETRA NERA  
BLACK STONE  
SCHWARZER STEIN  
PIERRE NOIRE



390  
CORTEN



391  
OSSIDO  
OXIDE



670  
FOGLIA ORO  
GOLD LEAF  
ALT GOLD  
FEUILLE D'OR

IT Misure espresse in mm, tolleranza +/- 1-2 mm. L'azienda si riserva la facoltà di apportare variazioni di dati caratteristici, materiali, design, stili, tonalità, senza alcun preavviso.  
EN Measures in mm, tolerance +/- 1/2 mm. The company reserves the right to carry out variations to technical details, materials, design, style, colors with no previous notice.

DE Die Masse sind in mm, mit einer Tolleranz von +/- 1-2 mm ausgedrückt, Die Firma behält sich das Recht vor ohne Voranmeldung Änderungen an den Werkstoffen, am Design, am Stil und an der Färbung vorzunehmen.  
FR Mesures en mm, tolérance +/- 1/2 mm. La société se réserve le droit de modifier sans préavis les détails techniques, les matériaux, le design, le style et les couleurs.

**A PARETE**  
Wall lighting  
Wandleuchten  
Appliques

CERAMICA 9000

made in Italy

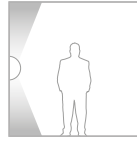

DATI TECNICI / TECHNICAL DATA	
2293-41	E27 52W-240V L 135mm Ø45
2293-51	R7s 78mm 120W-240V
2293-57	R7s 118mm MAX 20W-220-240V
2293-3058	LED 12W-220-240V-1800lm-3000°K-CRI85
2293-2758	LED 12W-220-240V-1700lm-2700°K-CRI85
2293-4058	LED 12W-220-240V-1900lm-4000°K-CRI85
2293-3058T	DIM LED* 12W-220-240V-1800lm-3000°K-CRI85
2293-2758T	DIM LED* 12W-220-240V-1700lm-2700°K-CRI85
2293-4058T	DIM LED* 12W-220-240V-1900lm-4000°K-CRI85

\* Alimentatore dimmerabile a taglio di fase / Dimmable phase cut power supply / Dimmbare Phasenanschnitt-Betriebsgerät / Alimentation dimmable à coupure de phase

2293

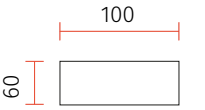
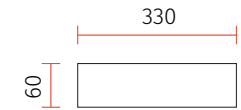

Art. 8342 - Private house - Locarno, Switzerland



2293  
FINITURE SU RICHIESTA / FINISHES ON DEMAND  
OBERFLÄCHENVERARBEITUNGEN AUF NACHFRAGE / FINITIONS SUR DEMANDE:

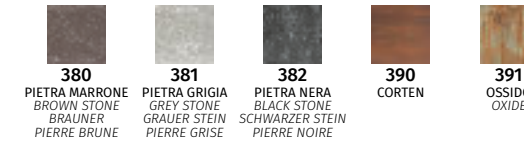

DATI TECNICI / TECHNICAL DATA	
8342-41	E27 52W-240V L 165mm
8342-3058	LED 12W-220-240V-1800lm-3000°K-CRI85
8342-2758	LED 12W-220-240V-1700lm-2700°K-CRI85
8342-4058	LED 12W-220-240V-1900lm-4000°K-CRI85
8342-3058T	DIM LED* 12W-220-240V-1800lm-3000°K-CRI85
8342-2758T	DIM LED* 12W-220-240V-1700lm-2700°K-CRI85
8342-4058T	DIM LED* 12W-220-240V-1900lm-4000°K-CRI85

\* Alimentatore dimmerabile a taglio di fase / Dimmable phase cut power supply / Dimmbare Phasenanschnitt-Betriebsgerät / Alimentation dimmable à coupure de phase

8342

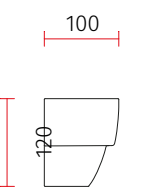
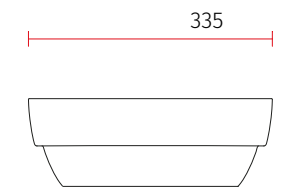
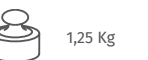

2293:  
Diffusore in vetro  
Glass diffuser  
Glasabdeckung  
Diffuseur en verre

IT Misure espresse in mm, tolleranza +/- 1-2 mm. L'azienda si riserva la facoltà di apportare variazioni di dati caratteristici, materiali, design, stili, tonalità, senza alcun preavviso.  
EN Measures in mm, tolerance +/- 1/2 mm. The company reserves the right to carry out variations to technical details, materials, design, style, colors with no previous notice.

DE Die Masse sind in mm, mit einer Tolleranz von +/- 1-2 mm ausgedrückt, Die Firma behält sich das Recht vor ohne Voranmeldung Änderungen an den Werkstoffen, am Design, am Stil und an der Färbung vorzunehmen.  
FR Mesures en mm, tolérance +/- 1/2 mm. La société se réserve le droit de modifier sans préavis les détails techniques, les matériaux, le design, le style et les couleurs.

# A PARETE

## Wall lighting

## Wandleuchten

## Appliques

CERAMICA 9020

made in Italy



Art. 2304 / 5507C / P001 / 4178 - B&B - Bologna, Italy



IT Misure espresse in mm, tolleranza +/- 1-2 mm. L'azienda si riserva la facoltà di apportare variazioni di dati caratteristici, materiali, design, stili, tonalità, senza alcun preavviso.  
EN Measures in mm, tollerance +/- 1/2 mm. The company reserves the right to carry out variations to technical details, materials, design, style, colors with no previous notice.

### DATI TECNICI / TECHNICAL DATA

2304-95	R7s 78mm 80W-240V
2304-57	R7s 118mm MAX 20W-220-240V
2304-3064	LED 12W-220-240V-1800lm-3000°K-CRI85
2304-2764	LED 12W-220-240V-1700lm-2700°K-CRI85
2304-4064	LED 12W-220-240V-1900lm-4000°K-CRI85
2304-3064T	DIM LED* 12W-220-240V-1800lm-3000°K-CRI85
2304-2764T	DIM LED* 12W-220-240V-1700lm-2700°K-CRI85
2304-4064T	DIM LED* 12W-220-240V-1900lm-4000°K-CRI85

\* Alimentatore dimmerabile a taglio di fase / Dimmable phase cut power supply / Dimmbare Phasenanschnitt-Betriebsgerät / Alimentation dimmable à coupure de phase

#### 2304

FINITURE SU RICHIESTA / FINISHES ON DEMAND  
OBERFLÄCHENVERARBEITUNGEN AUF NACHFRAGE / FINITIONS SUR DEMANDE:

380 PIETRA MARRONE BROWN STONE BRÄUNER PIERRE BRUNE	381 PIETRA GRIGIA GREY STONE GRAUER STEIN PIERRE GRISE	382 PIETRA NERA BLACK STONE SCHWARZER STEIN PIERRE NOIRE	390 CORTEN	391 OSSIDO OXIDE	670 FOGLIA ORO GOLD LEAF ALT GOLD FEUILLE D'OR

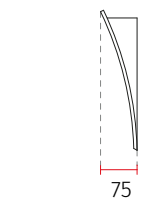
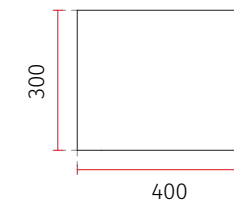

### DATI TECNICI / TECHNICAL DATA

2304B-3050	LED 6W-220-240V-900lm-3000°K-CRI85
2304B-2750	LED 6W-220-240V-850lm-2700°K-CRI85
2304B-4050	LED 6W-220-240V-950lm-4000°K-CRI85
2304B-3050T	DIM LED* 6W-220-240V-900lm-3000°K-CRI85
2304B-2750T	DIM LED* 6W-220-240V-850lm-2700°K-CRI85
2304B-4050T	DIM LED* 6W-220-240V-950lm-4000°K-CRI85

\* Alimentatore dimmerabile a taglio di fase / Dimmable phase cut power supply / Dimmbare Phasenanschnitt-Betriebsgerät / Alimentation dimmable à coupure de phase

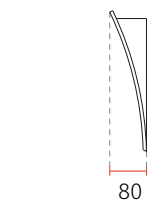
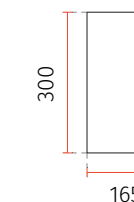

### DATI TECNICI / TECHNICAL DATA

2509-3051	LED 9W-220-240V-1350lm-3000°K-CRI85
2509-2751	LED 9W-220-240V-1300lm-2700°K-CRI85
2509-4051	LED 9W-220-240V-1400lm-4000°K-CRI85
2509-3051T	DIM LED* 9W-220-240V-1350lm-3000°K-CRI85
2509-2751T	DIM LED* 9W-220-240V-1300lm-2700°K-CRI85
2509-4051T	DIM LED* 9W-220-240V-1400lm-4000°K-CRI85

\* Alimentatore dimmerabile a taglio di fase / Dimmable phase cut power supply / Dimmbare Phasenanschnitt-Betriebsgerät / Alimentation dimmable à coupure de phase

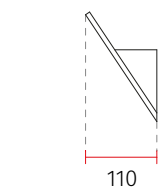
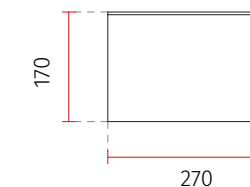

DE Die Masse sind in mm, mit einer Tolleranz von +/- 1-2 mm ausgedrückt, Die Firma behält sich das Recht vor ohne Voranmeldung Änderungen an den Werkstoffen, am Design, am Stil und an der Färbung vorzunehmen.  
FR Mesures en mm, tolérance +/- 1/2 mm. La société se réserve le droit de modifier sans préavis les détails techniques, les matériaux, le design, le style et les couleurs.

# 2304



# NEW 2304B



# NEW 2509



# A PARETE

## Wall lighting

## Wandleuchten

## Appliques

CERAMICA 9010

made in Italy



Art. 2336 - Private house - Pescara, Italy



### DATI TECNICI / TECHNICAL DATA

2336-52 G9 33W-240V L 50mm

2336



0,6 Kg

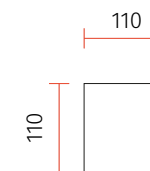
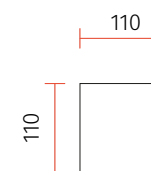

### 2336 FINITURE SU RICHIESTA / FINISHES ON DEMAND OBERFLÄCHENVERARBEITUNGEN AUF NACHFRAGE / FINITIONS SUR DEMANDE:

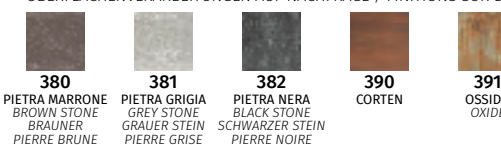

### DATI TECNICI / TECHNICAL DATA

2336B-3082	LED 12W-220-240V-1800lm-3000°K-CRI85
2336B-2782	LED 12W-220-240V-1700lm-2700°K-CRI85
2336B-4082	LED 12W-220-240V-1900lm-4000°K-CRI85
2336B-3082T	DIM LED* 12W-220-240V-1800lm-3000°K-CRI85
2336B-2782T	DIM LED* 12W-220-240V-1700lm-2700°K-CRI85
2336B-4082T	DIM LED* 12W-220-240V-1900lm-4000°K-CRI85

\* Alimentatore dimmerabile a taglio di fase / Dimmable phase cut power supply /  
Dimmbare Phasenanschnitt-Betriebsgerät / Alimentation dimmable à coupure de phase

2336B



1,05 Kg

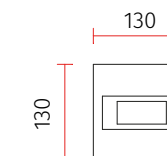
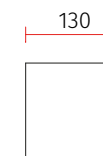

### 2336B FINITURE SU RICHIESTA / FINISHES ON DEMAND OBERFLÄCHENVERARBEITUNGEN AUF NACHFRAGE / FINITIONS SUR DEMANDE:

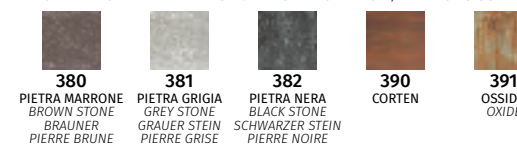

### DATI TECNICI / TECHNICAL DATA

2511-3050	LED 6W-220-240V-900lm-3000°K-CRI85
2511-2750	LED 6W-220-240V-850lm-2700°K-CRI85
2511-4050	LED 6W-220-240V-950lm-4000°K-CRI85
2511-3050T	DIM LED* 6W-220-240V-900lm-3000°K-CRI85
2511-2750T	DIM LED* 6W-220-240V-850lm-2700°K-CRI85
2511-4050T	DIM LED* 6W-220-240V-950lm-4000°K-CRI85

\* Alimentatore dimmerabile a taglio di fase / Dimmable phase cut power supply /  
Dimmbare Phasenanschnitt-Betriebsgerät / Alimentation dimmable à coupure de phase

### ACCESSORI / ACCESSORIES

024.326	Vetro di protezione / Protection glass / Schutzglas / Verre de protection
---------	---

Designer  
**Alberto Ghirardello**  
>BOX

CRISTALY® 9010

2511



1,9 Kg

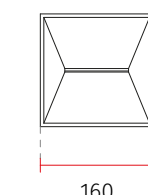
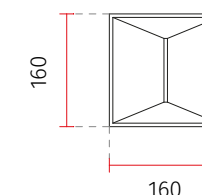

IT Misure espresse in mm, tolleranza +/- 1-2 mm. L'azienda si riserva la facoltà di apportare variazioni di dati caratteristici, materiali, design, stili, tonalità, senza alcun preavviso.  
EN Measures in mm, tolerance +/- 1/2 mm. The company reserves the right to carry out variations to technical details, materials, design, style, colors with no previous notice.

DE Die Masse sind in mm, mit einer Tolleranz von +/- 1-2 mm ausgedrückt, Die Firma behält sich das Recht vor ohne Voranmeldung Änderungen an den Werkstoffen, am Design, am Stil und an der Färbung vorzunehmen.  
FR Mesures en mm, tolérance +/- 1/2 mm. La société se réserve le droit de modifier sans préavis les détails techniques, les matériaux, le design, le style et les couleurs.



# A PARETE

## Wall lighting

## Wandleuchten

## Appliques

CERAMICA 2010

made in Italy

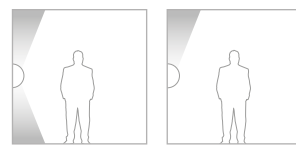

2388 / 2601A

2496



DATI TECNICI / TECHNICAL DATA	
2388-52	G9 60W-240V L 50mm
2388-3057	LED 9W-220-240V-1350lm-3000°K-CRI85
2388-2757	LED 9W-220-240V-1300lm-2700°K-CRI85
2388-4057	LED 9W-220-240V-1400lm-4000°K-CRI85
2388-3057T	DIM LED* 9W-220-240V-1350lm-3000°K-CRI85
2388-2757T	DIM LED* 9W-220-240V-1300lm-2700°K-CRI85
2388-4057T	DIM LED* 9W-220-240V-1400lm-4000°K-CRI85

\* Alimentatore dimmerabile a taglio di fase / Dimmable phase cut power supply / Dimmbare Phasenanschnitt-Betriebsgerät / Alimentation dimmable à coupure de phase

# 2388

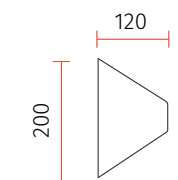

Art. 2388 - Private house - Lille, France



Art. 2496



DATI TECNICI / TECHNICAL DATA	
2496-3050	LED 6W-220-240V-900lm-3000°K-CRI85
2496-2750	LED 6W-220-240V-850lm-2700°K-CRI85
2496-4050	LED 6W-220-240V-950lm-4000°K-CRI85
2496-3050T	DIM LED* 6W-220-240V-900lm-3000°K-CRI85
2496-2750T	DIM LED* 6W-220-240V-850lm-2700°K-CRI85
2496-4050T	DIM LED* 6W-220-240V-950lm-4000°K-CRI85

\* Alimentatore dimmerabile a taglio di fase / Dimmable phase cut power supply / Dimmbare Phasenanschnitt-Betriebsgerät / Alimentation dimmable à coupure de phase

NEW

# 2496

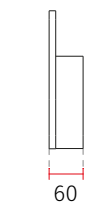
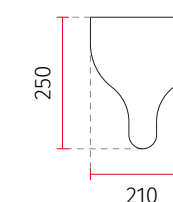

Art. 2601A



DATI TECNICI / TECHNICAL DATA	
2601A-52	G9 60W-240V L 50mm
2601A-3056	LED 6W-220-240V-900lm-3000°K-CRI85
2601A-2756	LED 6W-220-240V-850lm-2700°K-CRI85
2601A-4056	LED 6W-220-240V-950lm-4000°K-CRI85
2601A-3056T	DIM LED* 6W-220-240V-900lm-3000°K-CRI85
2601A-2756T	DIM LED* 6W-220-240V-850lm-2700°K-CRI85
2601A-4056T	DIM LED* 6W-220-240V-950lm-4000°K-CRI85

\* Alimentatore dimmerabile a taglio di fase / Dimmable phase cut power supply / Dimmbare Phasenanschnitt-Betriebsgerät / Alimentation dimmable à coupure de phase

# 2601A

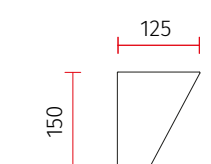
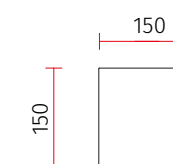

IT Misure espresse in mm, tolleranza +/- 1-2 mm. L'azienda si riserva la facoltà di apportare variazioni di dati caratteristici, materiali, design, stili, tonalità, senza alcun preavviso.  
EN Measures in mm, tolerance +/- 1/2 mm. The company reserves the right to carry out variations to technical details, materials, design, style, colors with no previous notice.

DE Die Masse sind in mm, mit einer Tolleranz von +/- 1-2 mm ausgedrückt, Die Firma behält sich das Recht vor ohne Voranmeldung Änderungen an den Werkstoffen, am Design, am Stil und an der Färbung vorzunehmen.  
FR Mesures en mm, tolérance +/- 1/2 mm. La société se réserve le droit de modifier sans préavis les détails techniques, les matériaux, le design, le style et les couleurs.

**A PARETE**  
Wall lighting  
Wandleuchten  
Appliques

CERAMICA 1010

made in Italy

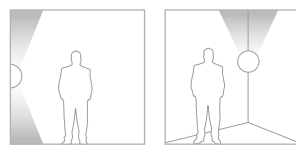

2602A 2396



DATI TECNICI / TECHNICAL DATA	
2396-35	GU10 ø50 MAX 50W-240V L 100mm
2396-44	E27 52W-240V L 130mm

**2396**

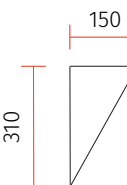
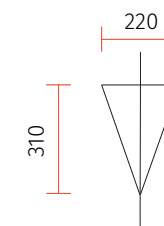

Art. 2602A



Art. 2396

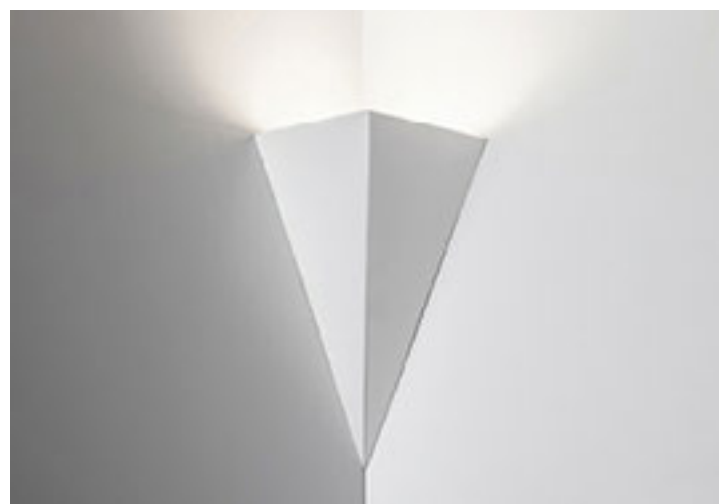

DATI TECNICI / TECHNICAL DATA	
2602A-41	E27 52W-240V L 150mm

**2602A**

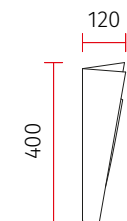
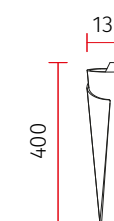

IT Misure espresse in mm, tolleranza +/- 1-2 mm. L'azienda si riserva la facoltà di apportare variazioni di dati caratteristici, materiali, design, stili, tonalità, senza alcun preavviso.  
EN Measures in mm, tolerance +/- 1/2 mm. The company reserves the right to carry out variations to technical details, materials, design, style, colors with no previous notice.

DE Die Masse sind in mm, mit einer Tolleranz von +/- 1-2 mm ausgedrückt, Die Firma behält sich das Recht vor ohne Voranmeldung Änderungen an den Werkstoffen, am Design, am Stil und an der Färbung vorzunehmen.  
FR Mesures en mm, tolérance +/- 1/2 mm. La société se réserve le droit de modifier sans préavis les détails techniques, les matériaux, le design, le style et les couleurs.



**A PARETE**  
Wall lighting  
Wandleuchten  
Appliques

CERAMICA 1000

made in Italy

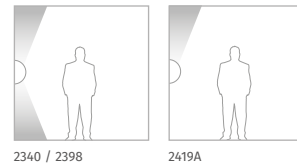

Art. 2419A - Private house - Granada, Spain



**DATI TECNICI / TECHNICAL DATA**

2340-41	E27 52W-240V L 115mm Ø45
2340-51	R7s 78mm 120W-240V
2340-57	R7s 118mm MAX 20W-220-240V
2340-3057	LED 9W-220-240V-1350lm-3000°K-CRI85
2340-2757	LED 9W-220-240V-1300lm-2700°K-CRI85
2340-4057	LED 9W-220-240V-1400lm-4000°K-CRI85
2340-3057T	DIM LED* 9W-220-240V-1350lm-3000°K-CRI85
2340-2757T	DIM LED* 9W-220-240V-1300lm-2700°K-CRI85
2340-4057T	DIM LED* 9W-220-240V-1400lm-4000°K-CRI85

\* Alimentatore dimmerabile a taglio di fase / Dimmable phase cut power supply /  
Dimmbare Phasenanschnitt-Betriebsgerät / Alimentation dimmable à coupure de phase



Diffusore in vetro  
Glass diffuser  
Glasabdeckung  
Diffuseur en verre

**DATI TECNICI / TECHNICAL DATA**

2398-52	G9 2X33W-240V L 50mm
---------	----------------------

**DATI TECNICI / TECHNICAL DATA**

2419A-41	E27 52W-240V L 150mm
----------	----------------------

**2340**



0,85 Kg

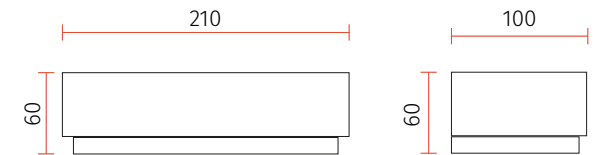

**2398**



0,75 Kg

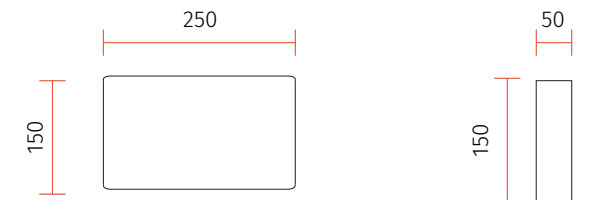

**2419A**



1,3 Kg

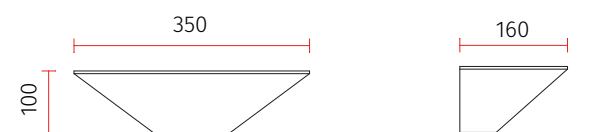

IT Misure espresse in mm, tolleranza +/- 1-2 mm. L'azienda si riserva la facoltà di apportare variazioni di dati caratteristici, materiali, design, stili, tonalità, senza alcun preavviso.  
EN Measures in mm, tolerance +/- 1/2 mm. The company reserves the right to carry out variations to technical details, materials, design, style, colors with no previous notice.

DE Die Masse sind in mm, mit einer Tolleranz von +/- 1-2 mm ausgedrückt, Die Firma behält sich das Recht vor ohne Voranmeldung Änderungen an den Werkstoffen, am Design, am Stil und an der Färbung vorzunehmen.  
FR Mesures en mm, tolérance +/- 1/2 mm. La société se réserve le droit de modifier sans préavis les détails techniques, les matériaux, le design, le style et les couleurs.

Art. 2340 - Private house - Perugia, Italy



# A PARETE

Wall lighting  
Wandleuchten  
Appliques

CRISTALY®

made in Italy



IP20

CASAMBI Pg.408

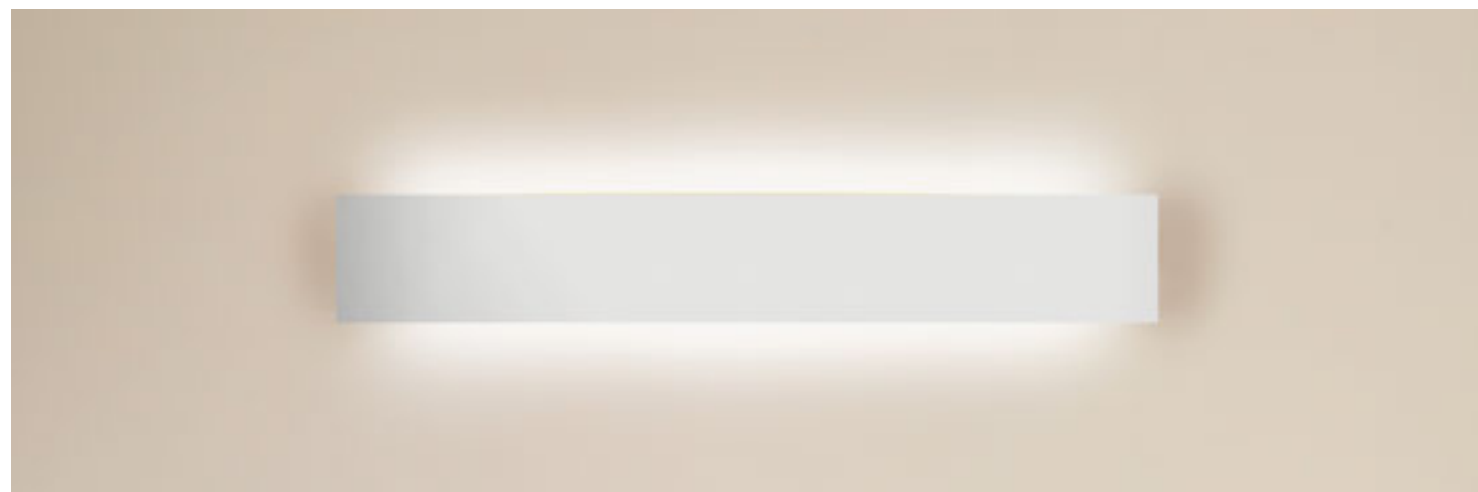

L'alimentatore dimmerabile non può essere installato nell'appliche ma deve essere installato in una scatola di derivazione remota.

EN The dimmable driver shall not be installed in the wall lamp, but on a remote box.

DE Der dimmbare Betriebsgerät darf nicht in der Wandleuchte installiert werden, sondern im Schaltkasten

FR L'alimentation dimmable ne doit pas être installé dans l'applique, mais dans une boîte électrique

## DATI TECNICI / TECHNICAL DATA

2421C-3045	LED 37W-220-240V-4200lm-3000°K-CRI90
2421C-2745	LED 37W-220-240V-4000lm-2700°K-CRI90
2421C-4045	LED 37W-220-240V-4400lm-4000°K-CRI90

Versione senza alimentatore / Version without power supply /  
Version ohne Betribesgerät / Version sans alimentation:

2421C-3003	LED 37W-24Vdc-4200lm-3000°K-CRI90
2421C-2703	LED 37W-24Vdc-4000lm-2700°K-CRI90
2421C-4003	LED 37W-24Vdc-4400lm-4000°K-CRI90
026.260	DRIVER ON/OFF 60W 24V
026.261	DRIVER ON/OFF 150W 24V
026.262	DRIVER ON/OFF 240W 24V
026.209	DRIVER DIM PUSH/1-10V 60W 24V
026.190+026.261	DRIVER DIM PUSH/0-10V/DALI 150W 24V
026.190+026.262	DRIVER DIM PUSH/0-10V/DALI 240W 24V

## ACCESSORI / ACCESSORIES

099.142	Pg.415 Kit emergenza / Emergency Kit
---------	--------------------------------------



# 2421C



3,1 Kg

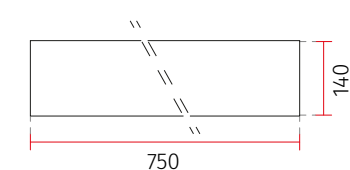

50

# 2421B



2,2 Kg

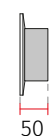
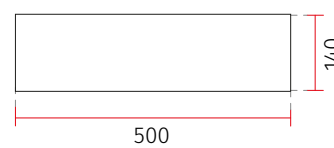

50

## DATI TECNICI / TECHNICAL DATA

2421B-3045	LED 24W-220-240V-2700lm-3000°K-CRI90
2421B-2745	LED 24W-220-240V-2600lm-2700°K-CRI90
2421B-4045	LED 24W-220-240V-2850lm-4000°K-CRI90

Versione senza alimentatore / Version without power supply /  
Version ohne Betribesgerät / Version sans alimentation:

2421B-3003	LED 24W-24Vdc-2700lm-3000°K-CRI90
2421B-2703	LED 24W-24Vdc-2600lm-2700°K-CRI90
2421B-4003	LED 24W-24Vdc-2850lm-4000°K-CRI90
026.259	DRIVER ON/OFF 36W 24V
026.260	DRIVER ON/OFF 60W 24V
026.261	DRIVER ON/OFF 150W 24V
026.262	DRIVER ON/OFF 240W 24V
026.209	DRIVER DIM PUSH/1-10V 60W 24V
026.190+026.261	DRIVER DIM PUSH/0-10V/DALI 150W 24V
026.190+026.262	DRIVER DIM PUSH/0-10V/DALI 240W 24V

## ACCESSORI / ACCESSORIES

099.142	Pg.415 Kit emergenza / Emergency Kit
---------	--------------------------------------

## DATI TECNICI / TECHNICAL DATA

2421D-3045	LED 50W-220-240V-5700lm-3000°K-CRI90
2421D-2745	LED 50W-220-240V-5450lm-2700°K-CRI90
2421D-4045	LED 50W-220-240V-6000lm-4000°K-CRI90

Versione senza alimentatore / Version without power supply /  
Version ohne Betribesgerät / Version sans alimentation:

2421D-3003	LED 50W-24Vdc-5700lm-3000°K-CRI90
2421D-2703	LED 50W-24Vdc-5450lm-2700°K-CRI90
2421D-4003	LED 50W-24Vdc-6000lm-4000°K-CRI90
026.260	DRIVER ON/OFF 60W 24V
026.261	DRIVER ON/OFF 150W 24V
026.262	DRIVER ON/OFF 240W 24V
026.209	DRIVER DIM PUSH/1-10V 60W 24V
026.190+026.261	DRIVER DIM PUSH/0-10V/DALI 150W 24V
026.190+026.262	DRIVER DIM PUSH/0-10V/DALI 240W 24V

## ACCESSORI / ACCESSORIES

099.142	Pg.415 Kit emergenza / Emergency Kit
---------	--------------------------------------

# 2421D



4,1 Kg

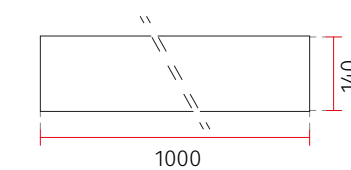

50

IT Misure espresse in mm, tolleranza +/- 1-2 mm. L'azienda si riserva la facoltà di apportare variazioni di dati caratteristici, materiali, design, stili, tonalità, senza alcun preavviso.  
EN Measures in mm, tollerance +/- 1/2 mm. The company reserves the right to carry out variations to technical details, materials, design, style, colors with no previous notice.

DE Die Masse sind in mm, mit einer Tolleranz von +/- 1-2 mm ausgedrückt, Die Firma behält sich das Recht vor ohne Voranmeldung Änderungen an den Werkstoffen, am Design, am Stil und an der Färbung vorzunehmen.  
FR Mesures en mm, tolérance +/- 1/2 mm. La société se réserve le droit de modifier sans préavis les détails techniques, les matériaux, le design, le style et les couleurs.

# A PARETE

## Wall lighting

## Wandleuchten

## Appliques

CRISTALY®

made in Italy

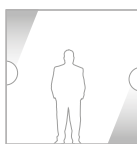

CASAMBI Pg.408

L'alimentatore dimmerabile non può essere installato nell'applicazione ma deve essere installato in una scatola di derivazione remota.

EN The dimmable driver shall not be installed in the wall lamp, but on a remote box.

DE Der dimmbare Betriebsgerät darf nicht in der Wandleuchte installiert werden, sondern im Schaltkasten

FR L'alimentation dimmable ne doit pas être installé dans l'applique, mais dans une boîte électrique

Art. 2422B - Private house - Vicenza, Italy



Schermo in metacrilato opalino goffrato  
Screen in opal methacrylate  
Abdeckung aus Opal-Methacrylat  
Couverture opale en methacrylate

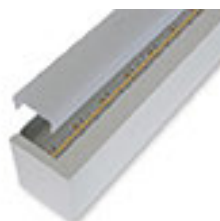

### DATI TECNICI / TECHNICAL DATA

2422B-3045	LED 16W-220-240V-1800lm-3000°K-CRI90
2422B-2745	LED 16W-220-240V-1700lm-2700°K-CRI90
2422B-4045	LED 16W-220-240V-1900lm-4000°K-CRI90

Versione senza alimentatore / Version without power supply /  
Version ohne Betriebsgerät / Version sans alimentation:

2422B-3003	LED 16W-24Vdc-1800lm-3000°K-CRI90
2422B-2703	LED 16W-24Vdc-1700lm-2700°K-CRI90
2422B-4003	LED 16W-24Vdc-1900lm-4000°K-CRI90
026.259	DRIVER ON/OFF 36W 24V
026.260	DRIVER ON/OFF 60W 24V
026.261	DRIVER ON/OFF 150W 24V
026.262	DRIVER ON/OFF 240W 24V
026.219	DRIVER DIM PUSH/0-10V/DALI 21.6W 24V
026.209	DRIVER DIM PUSH/1-10V 60W 24V
026.190+026.261	DRIVER DIM PUSH/0-10V/DALI 150W 24V
026.190+026.262	DRIVER DIM PUSH/0-10V/DALI 240W 24V

### ACCESSORI / ACCESSORIES

099.142	Pg.415 Kit emergenza / Emergency Kit
---------	--------------------------------------

FINITURE SU RICHIESTA / FINISHES ON DEMAND  
OBERFLÄCHENVERARBEITUNGEN AUF NACHFRAGE / FINITIONS SUR DEMANDE:



390  
CORTEN



391  
OSSIDO  
OXIDE

### DATI TECNICI / TECHNICAL DATA

2423B-3045	LED 8W-220-240V-900lm-3000°K-CRI90
2423B-2745	LED 8W-220-240V-850lm-2700°K-CRI90
2423B-4045	LED 8W-220-240V-950lm-4000°K-CRI90

Versione senza alimentatore / Version without power supply /  
Version ohne Betriebsgerät / Version sans alimentation:

2423B-3003	LED 8W-24Vdc-900lm-3000°K-CRI90
2423B-2703	LED 8W-24Vdc-850lm-2700°K-CRI90
2423B-4003	LED 8W-24Vdc-950lm-4000°K-CRI90
026.258	DRIVER ON/OFF 12W 24V
026.259	DRIVER ON/OFF 36W 24V
026.260	DRIVER ON/OFF 60W 24V
026.261	DRIVER ON/OFF 150W 24V
026.262	DRIVER ON/OFF 240W 24V
026.219	DRIVER DIM PUSH/0-10V/DALI 21.6W 24V
026.209	DRIVER DIM PUSH/1-10V 60W 24V
026.190+026.261	DRIVER DIM PUSH/0-10V/DALI 150W 24V
026.190+026.262	DRIVER DIM PUSH/0-10V/DALI 240W 24V

### ACCESSORI / ACCESSORIES

099.142	Pg.415 Kit emergenza / Emergency Kit
---------	--------------------------------------

FINITURE SU RICHIESTA / FINISHES ON DEMAND  
OBERFLÄCHENVERARBEITUNGEN AUF NACHFRAGE / FINITIONS SUR DEMANDE:



390  
CORTEN



391  
OSSIDO  
OXIDE

DE Die Masse sind in mm, mit einer Tolleranz von +/- 1-2 mm ausgedrückt, Die Firma behält sich das Recht vor ohne Voranmeldung Änderungen an den Werkstoffen, am Design, am Stil und an der Färbung vorzunehmen.  
FR Mesures en mm, tolérance +/- 1/2 mm. La société se réserve le droit de modifier sans préavis les détails techniques, les matériaux, le design, le style et les couleurs.

# 2422B



2,6 Kg

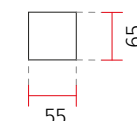
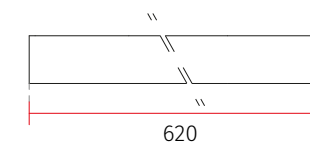

# 2423B



1,4 Kg

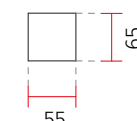
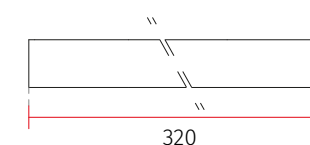

IT Misure espresse in mm, tolleranza +/- 1-2 mm. L'azienda si riserva la facoltà di apportare variazioni di dati caratteristici, materiali, design, stili, tonalità, senza alcun preavviso.  
EN Measures in mm, tolerance +/- 1/2 mm. The company reserves the right to carry out variations to technical details, materials, design, style, colors with no previous notice.

# A PARETE

## Wall lighting

## Wandleuchten

## Appliques

CRISTALY®

made in Italy



CASAMBI Pg.408

Art. 2427B-2429B - Private house - Bristol, England

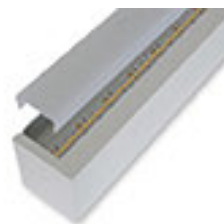

Schermo in metacrilato opalino gofrato  
Screen in opal methacrylate  
Abdeckung aus Opal-Methacrylat  
Couverture opale en methacrylate

L'alimentatore dimmerabile non può essere installato nell'applique ma deve essere installato in una scatola di derivazione remota.

EN The dimmable driver shall not be installed in the wall lamp, but on a remote box.

DE Das dimmbare Betriebsgerät darf nicht in der Wandleuchte installiert werden, sondern im Schaltkasten

FR L'alimentation dimmable ne doit pas être installé dans l'applique, mais dans une boîte électrique

IT Misure espresse in mm, tolleranza +/- 1-2 mm. L'azienda si riserva la facoltà di apportare variazioni di dati caratteristici, materiali, design, stili, tonalità, senza alcun preavviso.  
EN Measures in mm, tolerance +/- 1/2 mm. The company reserves the right to carry out variations to technical details, materials, design, style, colors with no previous notice.

### DATI TECNICI / TECHNICAL DATA

2427B-3045	LED 16W-220-240V-1800lm-3000°K-CRI90
2427B-2745	LED 16W-220-240V-1700lm-2700°K-CRI90
2427B-4045	LED 16W-220-240V-1900lm-4000°K-CRI90

Versione senza alimentatore / Version without power supply /  
Version ohne Betriebsgerät / Version sans alimentation:

2427B-3003	LED 16W-24Vdc-1800lm-3000°K-CRI90
2427B-2703	LED 16W-24Vdc-1700lm-2700°K-CRI90
2427B-4003	LED 16W-24Vdc-1900lm-4000°K-CRI90
026.259	DRIVER ON/OFF 36W 24V
026.260	DRIVER ON/OFF 60W 24V
026.261	DRIVER ON/OFF 150W 24V
026.262	DRIVER ON/OFF 240W 24V
026.219	DRIVER DIM PUSH/0-10V/DALI 21.6W 24V
026.209	DRIVER DIM PUSH/1-10V 60W 24V
026.190+026.261	DRIVER DIM PUSH/0-10V/DALI 150W 24V
026.190+026.262	DRIVER DIM PUSH/0-10V/DALI 240W 24V

### ACCESSORI / ACCESSORIES

099.142	Pg.415 Kit emergenza / Emergency Kit
---------	--------------------------------------

FINITURE SU RICHIESTA / FINISHES ON DEMAND  
OBERFLÄCHENVERARBEITUNGEN AUF NACHFRAGE / FINITIONS SUR DEMANDE:

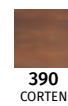

390  
CORTEN



391  
OSSIDO  
OXIDE

### DATI TECNICI / TECHNICAL DATA

2429B-3045	LED 32W-220-240V-3600lm-3000°K-CRI90
2429B-2745	LED 32W-220-240V-3400lm-2700°K-CRI90
2429B-4045	LED 32W-220-240V-3800lm-4000°K-CRI90

Versione senza alimentatore / Version without power supply /  
Version ohne Betriebsgerät / Version sans alimentation:

2429B-3003	LED 32W-24Vdc-3600lm-3000°K-CRI90
2429B-2703	LED 32W-24Vdc-3450lm-2700°K-CRI90
2429B-4003	LED 32W-24Vdc-3800lm-4000°K-CRI90
026.259	DRIVER ON/OFF 36W 24V
026.260	DRIVER ON/OFF 60W 24V
026.261	DRIVER ON/OFF 150W 24V
026.262	DRIVER ON/OFF 240W 24V
026.209	DRIVER DIM PUSH/1-10V 60W 24V
026.190+026.261	DRIVER DIM PUSH/0-10V/DALI 150W 24V
026.190+026.262	DRIVER DIM PUSH/0-10V/DALI 240W 24V

### ACCESSORI / ACCESSORIES

099.142	Pg.415 Kit emergenza / Emergency Kit
---------	--------------------------------------

FINITURE SU RICHIESTA / FINISHES ON DEMAND  
OBERFLÄCHENVERARBEITUNGEN AUF NACHFRAGE / FINITIONS SUR DEMANDE:

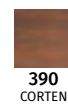

390  
CORTEN



391  
OSSIDO  
OXIDE

DE Die Masse sind in mm, mit einer Tolleranz von +/- 1-2 mm ausgedrückt, Die Firma behält sich das Recht vor ohne Voranmeldung Änderungen an den Werkstoffen, am Design, am Stil und an der Färbung vorzunehmen.  
FR Mesures en mm, tolérance +/- 1/2 mm. La société se réserve le droit de modifier sans préavis les détails techniques, les matériaux, le design, le style et les couleurs.

# 2427B



1,2 Kg

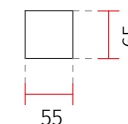
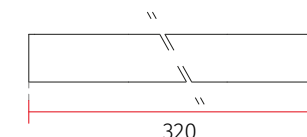

# 2429B



2 Kg

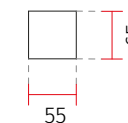
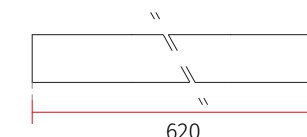

**A PARETE**  
Wall lighting  
Wandleuchten  
Appliques

CERAMICA 1000

made in Italy

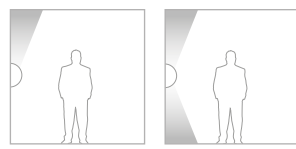

**DATI TECNICI / TECHNICAL DATA**

2438-3053	LED 15W-220-240V-2250lm-3000°K-CRI85
2438-2753	LED 15W-220-240V-2150lm-2700°K-CRI85
2438-4053	LED 15W-220-240V-2350lm-4000°K-CRI85
2438-3053T	DIM LED* 15W-220-240V-2250lm-3000°K-CRI85
2438-2753T	DIM LED* 15W-220-240V-2150lm-2700°K-CRI85
2438-4053T	DIM LED* 15W-220-240V-2350lm-4000°K-CRI85

\* Alimentatore dimmerabile a taglio di fase / Dimmable phase cut power supply / Dimmbare Phasenanschnitt-Betriebsgerät / Alimentation dimmable à coupure de phase

NEW

2438

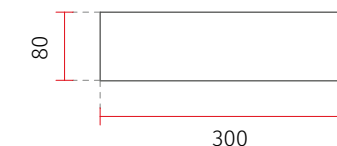

**DATI TECNICI / TECHNICAL DATA**

2474-3080	LED 18W-220-240V-2700lm-3000°K-CRI85
2474-2780	LED 18W-220-240V-2550lm-2700°K-CRI85
2474-4080	LED 18W-220-240V-2850lm-4000°K-CRI85
2474-3080T	DIM LED* 18W-220-240V-2700lm-3000°K-CRI85
2474-2780T	DIM LED* 18W-220-240V-2550lm-2700°K-CRI85
2474-4080T	DIM LED* 18W-220-240V-2850lm-4000°K-CRI85

\* Alimentatore dimmerabile a taglio di fase / Dimmable phase cut power supply / Dimmbare Phasenanschnitt-Betriebsgerät / Alimentation dimmable à coupure de phase

2474

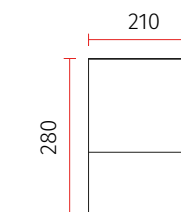

**DATI TECNICI / TECHNICAL DATA**

2497-3080	LED 18W-220-240V-2700lm-3000°K-CRI85
2497-2780	LED 18W-220-240V-2550lm-2700°K-CRI85
2497-4080	LED 18W-220-240V-2850lm-4000°K-CRI85
2497-3080T	DIM LED* 18W-220-240V-2700lm-3000°K-CRI85
2497-2780T	DIM LED* 18W-220-240V-2550lm-2700°K-CRI85
2497-4080T	DIM LED* 18W-220-240V-2850lm-4000°K-CRI85

\* Alimentatore dimmerabile a taglio di fase / Dimmable phase cut power supply / Dimmbare Phasenanschnitt-Betriebsgerät / Alimentation dimmable à coupure de phase

NEW

2497

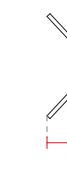
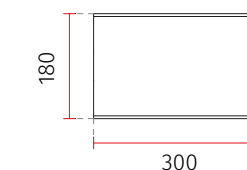

Designer

**Matteo Beraldi**  
>FOLIO

Art. 2474 - Private house - Udine, Italy



Art. 2438

Art. 2497

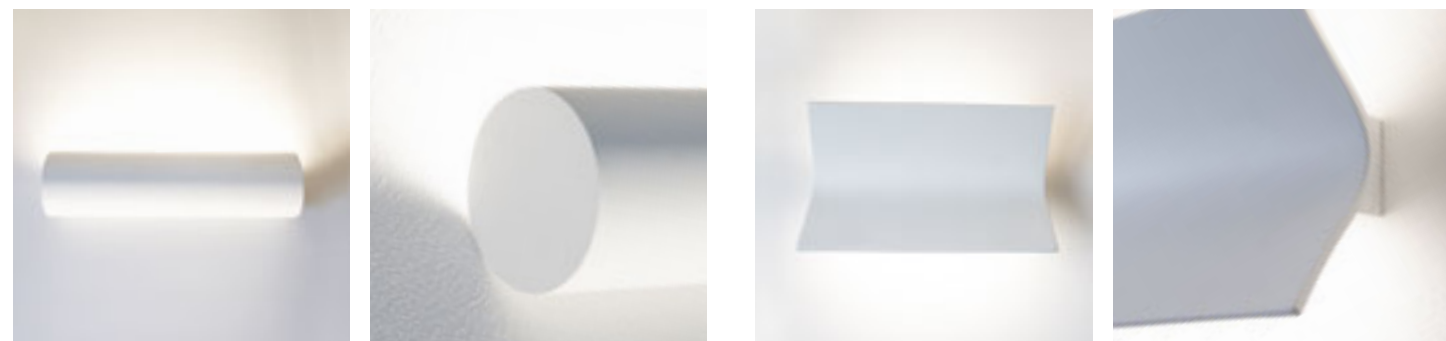

IT Misure espresse in mm, tolleranza +/- 1-2 mm. L'azienda si riserva la facoltà di apportare variazioni di dati caratteristici, materiali, design, stili, tonalità, senza alcun preavviso.  
EN Measures in mm, tolerance +/- 1/2 mm. The company reserves the right to carry out variations to technical details, materials, design, style, colors with no previous notice.

DE Die Masse sind in mm, mit einer Tolleranz von +/- 1-2 mm ausgedrückt, Die Firma behält sich das Recht vor ohne Voranmeldung Änderungen an den Werkstoffen, am Design, am Stil und an der Färbung vorzunehmen.  
FR Mesures en mm, tolérance +/- 1/2 mm. La société se réserve le droit de modifier sans préavis les détails techniques, les matériaux, le design, le style et les couleurs.

ESEMPIO DI INSTALLAZIONE ARTICOLO 2630 / Example of installation article 2630 /  
Installationsbeispiel für Artikel 2630 / Exemple d'installation de l'article 2630

**Fissare le staffe a parete**  
Fix the wall brackets  
Befestigen Sie die Wandhalterungen  
Fixer les supports muraux

**Mettere il collante (siliconico, poliuretano...) nel retro del corpo in CRISTALY®**  
Put the adhesive (silicone, polyurethane...) on the back of CRISTALY® lamp  
Tragen Sie den Kleber (Silikon, Polyurethan...) auf der Rückseite der CRISTALY®-Lampe auf  
Appliquer l'adhésif (silicone, polyuréthane...) au dos de la lampe en CRISTALY®

**Posizionare l'articolo alla parete e fissare le viti**  
Position the article on the wall and fix the screws  
Legen Sie den Artikel an die Wand und befestigen Sie die Schrauben  
Positionner l'article sur le mur et fixez les vis

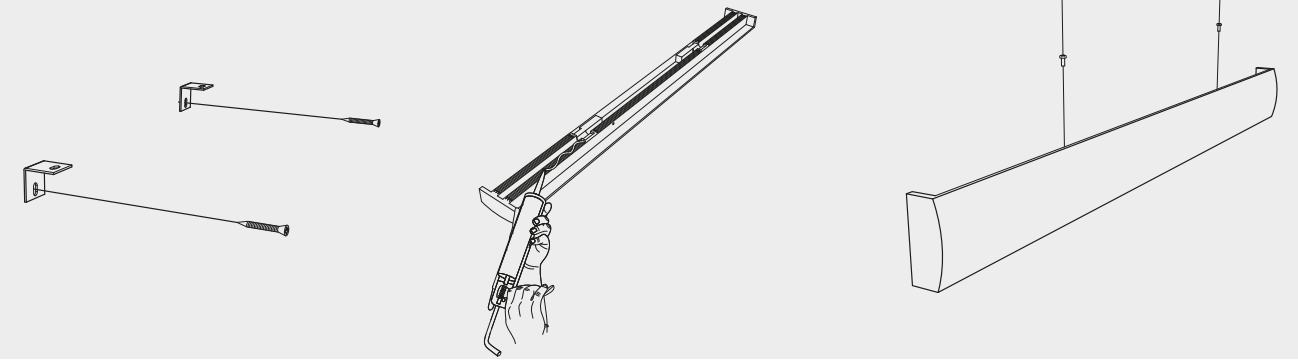

**Sezione 2630A/B/C/D**  
fornito di profili in alluminio dotati di  
schermo in metacrilato opalino

ENG Section 2630A / B / C / D equipped with  
ALUMITE® profiles and with opal methacrylate  
screen

DE Abschnitt 2630A / B / C / D, ausgestattet  
mit ALUMITE® Profilen und Abdeckungen aus  
Opal-Methacrylat

FR Section 2630A / B / C / D équipée de  
profilés en ALUMITE® et couverture en  
méthacrylate opal

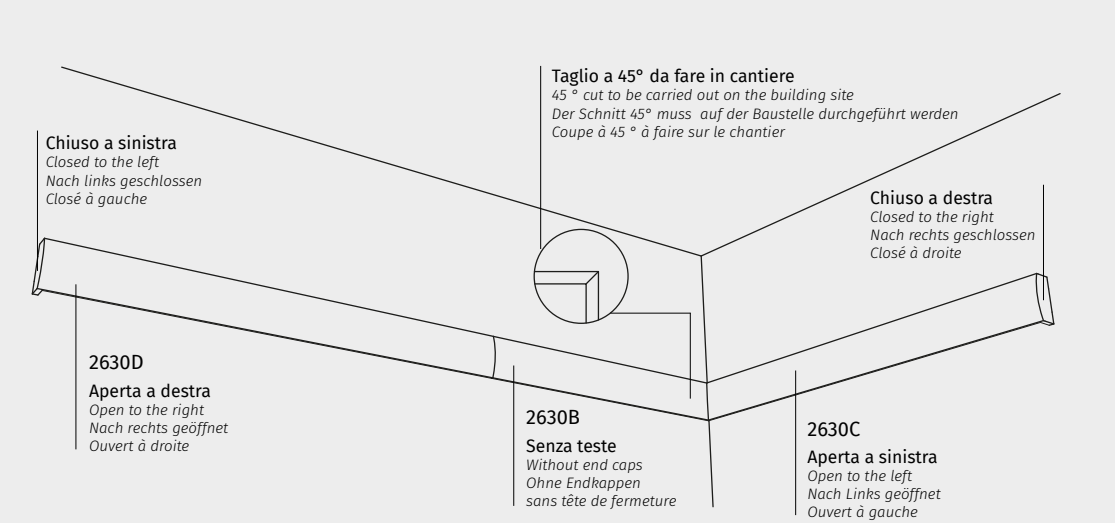
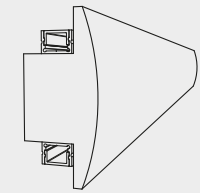

# LUCE DIFFUSA D'IMPATTO

LUCE INDIRETTA  
INDIRECT LIGHT

VERSATILE  
VERSATILE

DIVERSI DESIGN  
DIFFERENT DESIGNS

Profili in CRISTALY® e ALUMITE® dal design moderno, che grazie alla tecnologia LED 9010 permettono alla luce indiretta di illuminare adeguatamente gli ambienti. Una fonte luminosa invisibile ed uniforme, dall'ampia versatilità in quanto non richiedono installazione ad incasso.

EN CRISTALY® and ALUMITE® profiles with a modern design that, thanks to the LED 9010 technology, allows indirect light to adequately illuminate the rooms. An invisible and uniform light source, with great versatility since they do not require recessed installation.

DE Profile aus CRISTALY® und ALUMITE® mit modernem Design, die dank der Technologie LED 9010 für die richtige indirekte Raumbelichtung sorgen. Eine unsichtbare, gleichmäßige Lichtquelle mit hoher Vielseitigkeit, da keine Einbauinstallation erforderlich ist.

FR Profilés en CRISTALY® et ALUMITE® au design moderne qui, grâce à la technologie LED 9010, permettent à la lumière indirecte d'éclairer correctement les pièces. Une source de lumière invisible, uniforme et polyvalente, car elle ne requiert pas d'installation à encastrer.

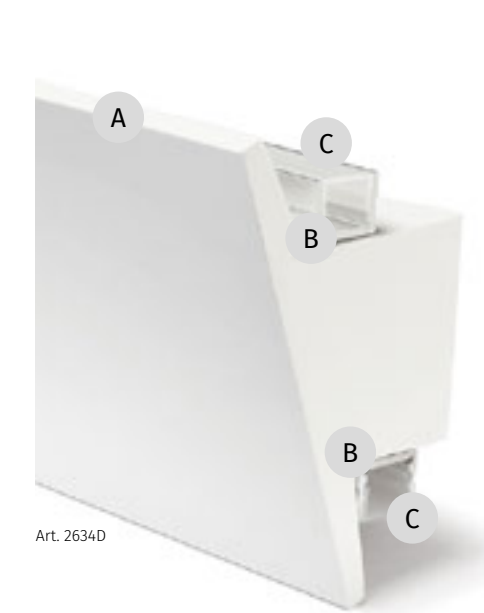

**A**  
Corpo in CRISTALY® per ogni esigenza  
CRISTALY® lamp suitable for any need  
Lampe aus CRISTALY® für jeden Gebrauch  
Lampe en CRISTALY® pour tout besoin

**B**  
Profili in ALUMITE®  
ALUMITE® profile  
ALUMITE®-Profil  
Profils ALUMITE®

**C**  
Schermi in metacrilato opalino  
Screens in opal methacrylate  
Abdeckungen aus Opal-Methacrylat  
Diffuseurs en méthacrylate opale

Art. 2634D

# A PARETE

Wall lighting  
Wandleuchten  
Appliques

CRISTALY®  
ALUMITE®  
made in Italy

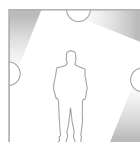

CASAMBI Pg.408

Art. 2443

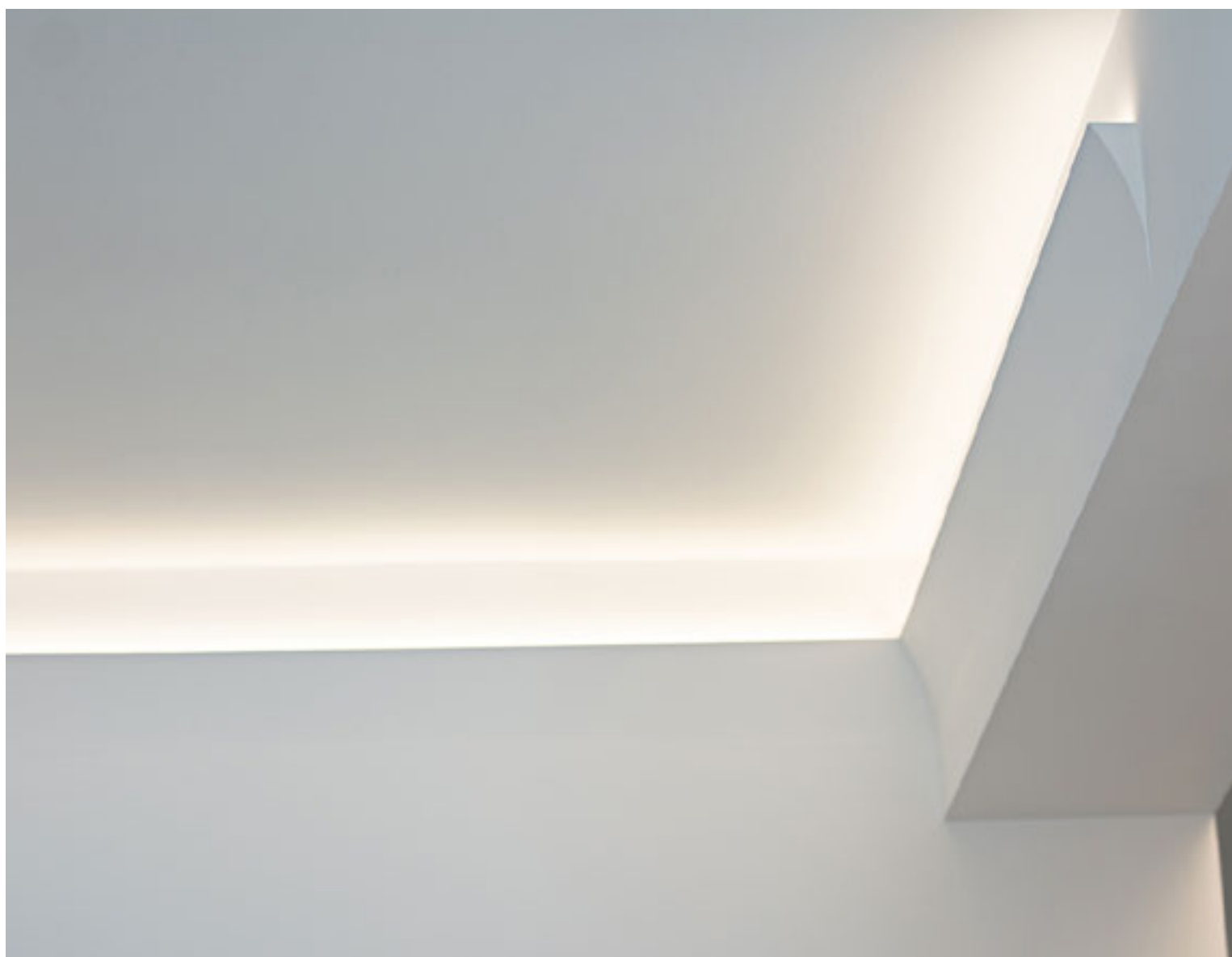

## 2443A - 2443B - 2443C - 2443D:

Nella Confezione di ogni singolo articolo viene fornito:  
- Profilo in CRISTALY®  
- Dissipatore/i in ALUMITE® e schermo in metacrilato opalino goffrato;  
STRIP LED 9010 DA ORDINARE SEPARATAMENTE

EN Included in the packaging of each article:  
- CRISTALY® profile  
- ALUMITE® heat diffuser and Screen in opal methacrylate;  
STRIP LED 9010 TO BE ORDERED SEPARATELY.

DE In der Verpackung der einzelnen Artikel ist inbegriffen:  
- CRISTALY® Profil  
- Eingebauter ALUMITE® Wärmeableiter und Abdeckung aus Opal-Methacrylat;  
LED STRIP 9010 SEPARAT ZU BESTELLEN.

FR Dans le paquet de chaque article est inclus:  
- Profil en CRISTALY®;  
- Dissipateur en ALUMITE® et couverture opal en methacrylate;  
RUBAN LED 9010 A' COMMANDER SEPARÉMENT

IT Misure espresse in mm, tolleranza +/- 1-2 mm. L'azienda si riserva la facoltà di apportare variazioni di dati caratteristici, materiali, design, stili, tonalità, senza alcun preavviso.  
EN Measures in mm, tolerance +/- 1/2 mm. The company reserves the right to carry out variations to technical details, materials, design, style, colors with no previous notice.

DATI TECNICI / TECHNICAL DATA	
2443A-00	L 980 Con Testate / With endcaps / Mit Endkappen / Avec tête de fermeture
ACCESSORI / ACCESSORIES	
LED Strip	Pg. 398

LED= MAX 20W/m

2443A

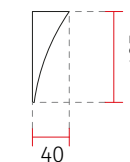
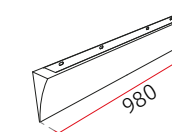

DATI TECNICI / TECHNICAL DATA	
2443B-00	L 980 Senza Testate / Without endcaps / Ohne Endkappen / Sans tête de fermeture
ACCESSORI / ACCESSORIES	
LED Strip	Pg. 398
TGC	Taglio a misura / Custom Cut / Zuschnitt / Coupe personnalisée

LED= MAX 20W/m

2443B

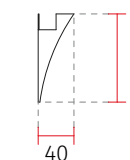
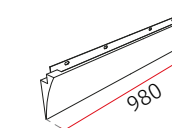

DATI TECNICI / TECHNICAL DATA	
2443C-00	L 980 Aperta a Destra / Open on the right / Nach rechts geöffnet / Ouvert à droite
ACCESSORI / ACCESSORIES	
LED Strip	Pg. 398
TGC	Taglio a misura / Custom Cut / Zuschnitt / Coupe personnalisée

LED= MAX 20W/m

2443C

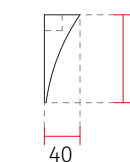
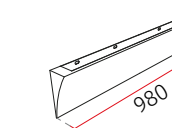

DATI TECNICI / TECHNICAL DATA	
2443D-00	L 980 Aperta a Sinistra / Open on the left / Nach links geöffnet / Ouvert à gauche
ACCESSORI / ACCESSORIES	
LED Strip	Pg. 398
TGC	Taglio a misura / Custom Cut / Zuschnitt / Coupe personnalisée

LED= MAX 20W/m

2443D

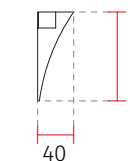
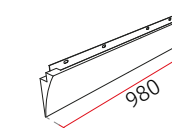

DE Die Masse sind in mm, mit einer Tolleranz von +/- 1-2 mm ausgedrückt, Die Firma behält sich das Recht vor ohne Voranmeldung Änderungen an den Werkstoffen, am Design, am Stil und an der Färbung vorzunehmen.  
FR Mesures en mm, tolérance +/- 1/2 mm. La société se réserve le droit de modifier sans préavis les détails techniques, les matériaux, le design, le style et les couleurs.



# A PARETE

## Wall lighting

## Wandleuchten

## Appliques

CRISTALY®  
ALUMITE®

made in Italy



Alimentatore all'interno dell'applique  
Power Supply inside the wall lamp  
Betriebsgerät in der Wandleuchte  
Alimentation à l'intérieur de l'article

### 2630A - 2630B - 2630C - 2630D:

Nella Confezione di ogni singolo articolo viene fornito:  
- Profilo in CRISTALY®  
- Dissipatore/i in ALUMITE® e schermo in metacrilato opalino goffrato;  
STRIP LED 9010 DA ORDINARE SEPARATAMENTE

EN Included in the packaging of each article:  
- CRISTALY® profile  
- ALUMITE® heat diffuser and Screen in opal methacrylate;  
STRIP LED 9010 TO BE ORDERED SEPARATELY.

DE In der Verpackung der einzelnen Artikel ist inbegriffen:  
- CRISTALY® Profil  
- Eingebauter ALUMITE® Wärmeableiter und Abdeckung aus Opal-Methacrylat;  
LED STRIP 9010 SEPARAT ZU BESTELLEN.

FR Dans le paquet de chaque article est inclus:  
- Profil en CRISTALY®;  
- Dissipateur en ALUMITE® et couverture opal en methacrylate;  
RUBAN LED 9010 A' COMMANDER SEPARÉMENT

IT Misure espresse in mm, tolleranza +/- 1-2 mm. L'azienda si riserva la facoltà di apportare variazioni di dati caratteristici, materiali, design, stili, tonalità, senza alcun preavviso.  
EN Measures in mm, tolerance +/- 1/2 mm. The company reserves the right to carry out variations to technical details, materials, design, style, colors with no previous notice.

### DATI TECNICI / TECHNICAL DATA

2630A-00 L 1000 Con Testate / With endcaps / Mit Endkappen / Avec tête de fermeture

### ACCESSORI / ACCESSORIES

LED Strip Pg. 398  
026.267 DRIVER ON/OFF SLIM max60W 24Vdc  
026.268 DRIVER ON/OFF SLIM max100W 24Vdc  
026.269 DRIVER ON/OFF SLIM max150W 24Vdc

LED= MAX 2x20W/m

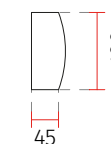
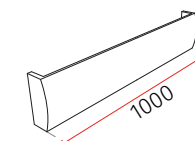

# 2630A



### DATI TECNICI / TECHNICAL DATA

2630B-00 L 1000 Senza Testate / Without endcaps / Ohne Endkappen / Sans tête de fermeture

### ACCESSORI / ACCESSORIES

LED Strip Pg. 398  
TGC Taglio a misura / Custom Cut / Zuschnitt / Coupe personnalisée  
026.267 DRIVER ON/OFF SLIM max60W 24Vdc  
026.268 DRIVER ON/OFF SLIM max100W 24Vdc  
026.269 DRIVER ON/OFF SLIM max150W 24Vdc

LED= MAX 2x20W/m

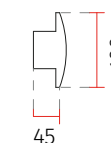
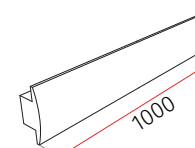

# 2630B

### DATI TECNICI / TECHNICAL DATA

2630C-00 L 1000 Aperta a Destra / Open on the right / Nach rechts geöffnet / Ouvert à droite

### ACCESSORI / ACCESSORIES

LED Strip Pg. 398  
TGC Taglio a misura / Custom Cut / Zuschnitt / Coupe personnalisée  
026.267 DRIVER ON/OFF SLIM max60W 24Vdc  
026.268 DRIVER ON/OFF SLIM max100W 24Vdc  
026.269 DRIVER ON/OFF SLIM max150W 24Vdc

LED= MAX 2x20W/m

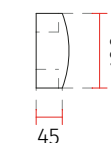
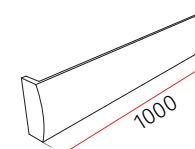

# 2630C

### DATI TECNICI / TECHNICAL DATA

2630D-00 L 1000 Aperta a Sinistra / Open on the left / Nach links geöffnet / Ouvert à gauche

### ACCESSORI / ACCESSORIES

LED Strip Pg. 398  
TGC Taglio a misura / Custom Cut / Zuschnitt / Coupe personnalisée  
026.267 DRIVER ON/OFF SLIM max60W 24Vdc  
026.268 DRIVER ON/OFF SLIM max100W 24Vdc  
026.269 DRIVER ON/OFF SLIM max150W 24Vdc

LED= MAX 2x20W/m

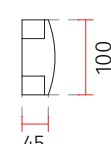
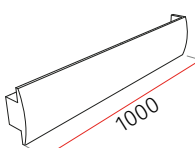

# 2630D

DE Die Masse sind in mm, mit einer Tolleranz von +/- 1-2 mm ausgedrückt, Die Firma behält sich das Recht vor ohne Voranmeldung Änderungen an den Werkstoffen, am Design, am Stil und an der Färbung vorzunehmen.  
FR Mesures en mm, tolérance +/- 1/2 mm. La société se réserve le droit de modifier sans préavis les détails techniques, les matériaux, le design, le style et les couleurs.

# A PARETE

## Wall lighting

## Wandleuchten

## Appliques

CRISTALY®  
ALUMITE®

made in Italy

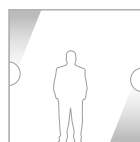

Alimentatore all'interno dell'applique  
Power Supply inside the wall lamp  
Betriebsgerät in der Wandleuchte  
Alimentation à l'intérieur de l'article

### 2632A - 2632B - 2632C - 2632D:

Nella Confezione di ogni singolo articolo viene fornito:  
- Profilo in CRISTALY®  
- Dissipatore/i in ALUMITE® e schermo in metacrilato opalino goffrato;  
STRIP LED 9010 DA ORDINARE SEPARATAMENTE

EN Included in the packaging of each article:  
- CRISTALY® profile  
- ALUMITE® heat diffuser and Screen in opal methacrylate;  
STRIP LED 9010 TO BE ORDERED SEPARATELY.

DE In der Verpackung der einzelnen Artikel ist inbegriffen:  
- CRISTALY® Profil  
- Eingebauter ALUMITE® Wärmeableiter und Abdeckung aus Opal-Methacrylat;  
LED STRIP 9010 SEPARAT ZU BESTELLEN.

FR Dans le paquet de chaque article est inclus:  
- Profil en CRISTALY®;  
- Dissipateur en ALUMITE® et couverture opal en methacrylate;  
RUBAN LED 9010 A' COMMANDER SEPARÉMENT

IT Misure espresse in mm, tolleranza +/- 1-2 mm. L'azienda si riserva la facoltà di apportare variazioni di dati caratteristici, materiali, design, stili, tonalità, senza alcun preavviso.  
EN Measures in mm, tolerance +/- 1/2 mm. The company reserves the right to carry out variations to technical details, materials, design, style, colors with no previous notice.

DATI TECNICI / TECHNICAL DATA	
2632A-00	L 1000 Con Testate / With endcaps / Mit Endkappen / Avec tête de fermeture
ACCESSORI / ACCESSORIES	
LED Strip	Pg. 398
026.267	DRIVER ON/OFF SLIM max60W 24Vdc
026.268	DRIVER ON/OFF SLIM max100W 24Vdc
026.269	DRIVER ON/OFF SLIM max150W 24Vdc

LED= MAX 20W/m

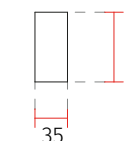
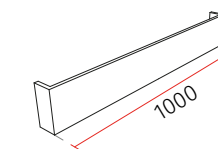

NEW 2632A

DATI TECNICI / TECHNICAL DATA	
2632B-00	L 1000 Senza Testate / Without endcaps / Ohne Endkappen / Sans tête de fermeture
ACCESSORI / ACCESSORIES	
LED Strip	Pg. 398
TGC	Taglio a misura / Custom Cut / Zuschnitt / Coupe personnalisée
026.267	DRIVER ON/OFF SLIM max60W 24Vdc
026.268	DRIVER ON/OFF SLIM max100W 24Vdc
026.269	DRIVER ON/OFF SLIM max150W 24Vdc

LED= MAX 20W/m

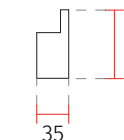
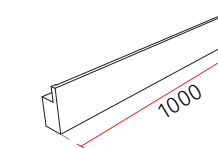

NEW 2632B

DATI TECNICI / TECHNICAL DATA	
2632C-00	L 1000 Aperta a Destra / Open on the right / Nach rechts geöffnet / Ouvert à droite
ACCESSORI / ACCESSORIES	
LED Strip	Pg. 398
TGC	Taglio a misura / Custom Cut / Zuschnitt / Coupe personnalisée
026.267	DRIVER ON/OFF SLIM max60W 24Vdc
026.268	DRIVER ON/OFF SLIM max100W 24Vdc
026.269	DRIVER ON/OFF SLIM max150W 24Vdc

LED= MAX 20W/m

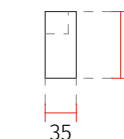
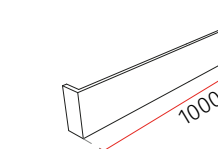

NEW 2632C

DATI TECNICI / TECHNICAL DATA	
2632D-00	L 1000 Aperta a Sinistra / Open on the left / Nach links geöffnet / Ouvert à gauche
ACCESSORI / ACCESSORIES	
LED Strip	Pg. 398
TGC	Taglio a misura / Custom Cut / Zuschnitt / Coupe personnalisée
026.267	DRIVER ON/OFF SLIM max60W 24Vdc
026.268	DRIVER ON/OFF SLIM max100W 24Vdc
026.269	DRIVER ON/OFF SLIM max150W 24Vdc

LED= MAX 20W/m

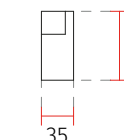
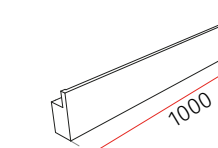

NEW 2632D

DE Die Masse sind in mm, mit einer Tolleranz von +/- 1-2 mm ausgedrückt, Die Firma behält sich das Recht vor ohne Voranmeldung Änderungen an den Werkstoffen, am Design, am Stil und an der Färbung vorzunehmen.  
FR Mesures en mm, tolérance +/- 1/2 mm. La société se réserve le droit de modifier sans préavis les détails techniques, les matériaux, le design, le style et les couleurs.

# A PARETE

## Wall lighting

## Wandleuchten

## Appliques

CRISTALY®  
ALUMITE®

made in Italy



Alimentatore all'interno dell'applique  
Power Supply inside the wall lamp  
Betriebsgerät in der Wandleuchte  
Alimentation à l'intérieur de l'article

### 2634A - 2634B - 2634C - 2634D:

Nella Confezione di ogni singolo articolo viene fornito:  
- Profilo in CRISTALY®  
- Dissipatore/i in ALUMITE® e schermo in metacrilato opalino goffrato;  
STRIP LED 9010 DA ORDINARE SEPARATAMENTE

EN Included in the packaging of each article:  
- CRISTALY® profile  
- ALUMITE® heat diffuser and Screen in opal methacrylate;  
STRIP LED 9010 TO BE ORDERED SEPARATELY.

DE In der Verpackung der einzelnen Artikel ist inbegriffen:  
- CRISTALY® Profil  
- Eingebauter ALUMITE® Wärmeableiter und Abdeckung aus Opal-Methacrylat;  
LED STRIP 9010 SEPARAT ZU BESTELLEN.

FR Dans le paquet de chaque article est inclus:  
- Profil en CRISTALY®;  
- Dissipateur en ALUMITE® et couverture opal en methacrylate;  
RUBAN LED 9010 A' COMMANDER SEPARÉMENT

IT Misure espresse in mm, tolleranza +/- 1-2 mm. L'azienda si riserva la facoltà di apportare variazioni di dati caratteristici, materiali, design, stili, tonalità, senza alcun preavviso.  
EN Measures in mm, tolerance +/- 1/2 mm. The company reserves the right to carry out variations to technical details, materials, design, style, colors with no previous notice.

#### DATI TECNICI / TECHNICAL DATA

2634A-00 L 1000 Con Testate / With endcaps / Mit Endkappen / Avec tête de fermeture

#### ACCESSORI / ACCESSORIES

LED Strip Pg. 398  
026.267 DRIVER ON/OFF SLIM max60W 24Vdc  
026.268 DRIVER ON/OFF SLIM max100W 24Vdc  
026.269 DRIVER ON/OFF SLIM max150W 24Vdc

LED= MAX 2x20W/m

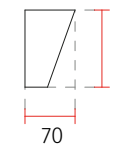
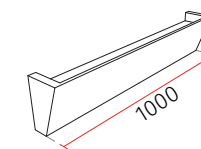

NEW 2634A



#### DATI TECNICI / TECHNICAL DATA

2634B-00 L 1000 Senza Testate / Without endcaps / Ohne Endkappen / Sans tête de fermeture

#### ACCESSORI / ACCESSORIES

LED Strip Pg. 398  
TGC Taglio a misura / Custom Cut / Zuschnitt / Coupe personnalisée  
026.267 DRIVER ON/OFF SLIM max60W 24Vdc  
026.268 DRIVER ON/OFF SLIM max100W 24Vdc  
026.269 DRIVER ON/OFF SLIM max150W 24Vdc

LED= MAX 2x20W/m

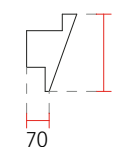
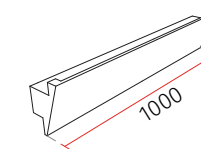

NEW 2634B



#### DATI TECNICI / TECHNICAL DATA

2634C-00 L 1000 Aperta a Destra / Open on the right / Nach rechts geöffnet / Ouvert à droite

#### ACCESSORI / ACCESSORIES

LED Strip Pg. 398  
TGC Taglio a misura / Custom Cut / Zuschnitt / Coupe personnalisée  
026.267 DRIVER ON/OFF SLIM max60W 24Vdc  
026.268 DRIVER ON/OFF SLIM max100W 24Vdc  
026.269 DRIVER ON/OFF SLIM max150W 24Vdc

LED= MAX 2x20W/m

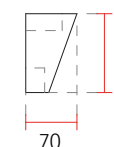
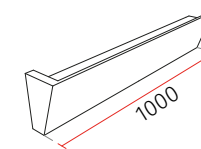

NEW 2634C



#### DATI TECNICI / TECHNICAL DATA

2634D-00 L 1000 Aperta a Sinistra / Open on the left / Nach links geöffnet / Ouvert à gauche

#### ACCESSORI / ACCESSORIES

LED Strip Pg. 398  
TGC Taglio a misura / Custom Cut / Zuschnitt / Coupe personnalisée  
026.267 DRIVER ON/OFF SLIM max60W 24Vdc  
026.268 DRIVER ON/OFF SLIM max100W 24Vdc  
026.269 DRIVER ON/OFF SLIM max150W 24Vdc

LED= MAX 2x20W/m

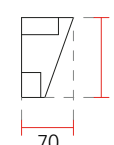
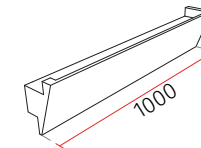

NEW 2634D



DE Die Masse sind in mm, mit einer Tolleranz von +/- 1-2 mm ausgedrückt, Die Firma behält sich das Recht vor ohne Voranmeldung Änderungen an den Werkstoffen, am Design, am Stil und an der Färbung vorzunehmen.  
FR Mesures en mm, tolérance +/- 1/2 mm. La société se réserve le droit de modifier sans préavis les détails techniques, les matériaux, le design, le style et les couleurs.

# A PARETE

## Wall lighting

## Wandleuchten

## Appliques

CRISTALY®  
ALUMITE®

made in Italy

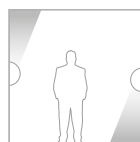

Alimentatore all'interno dell'applique  
Power Supply inside the wall lamp  
Betriebsgerät in der Wandleuchte  
Alimentation à l'intérieur de l'article

### 2635A - 2635B - 2635C - 2635D:

Nella Confezione di ogni singolo articolo viene fornito:  
- Profilo in CRISTALY®  
- Dissipatore/i in ALUMITE® e schermo in metacrilato opalino goffrato;  
STRIP LED 9010 DA ORDINARE SEPARATAMENTE

EN Included in the packaging of each article:  
- CRISTALY® profile  
- ALUMITE® heat diffuser and Screen in opal methacrylate;  
STRIP LED 9010 TO BE ORDERED SEPARATELY.

DE In der Verpackung der einzelnen Artikel ist inbegriffen:  
- CRISTALY® Profil  
- Eingebauter ALUMITE® Wärmeableiter und Abdeckung aus Opal-Methacrylat;  
LED STRIP 9010 SEPARAT ZU BESTELLEN.

FR Dans le paquet de chaque article est inclus:  
- Profil en CRISTALY®;  
- Dissipateur en ALUMITE® et couverture opal en methacrylate;  
RUBAN LED 9010 A' COMMANDER SEPARÉMENT

IT Misure espresse in mm, tolleranza +/- 1-2 mm. L'azienda si riserva la facoltà di apportare variazioni di dati caratteristici, materiali, design, stili, tonalità, senza alcun preavviso.  
EN Measures in mm, tolerance +/- 1/2 mm. The company reserves the right to carry out variations to technical details, materials, design, style, colors with no previous notice.

#### DATI TECNICI / TECHNICAL DATA

2635A-00 L 1000 Con Testate / With endcaps / Mit Endkappen / Avec tête de fermeture

#### ACCESSORI / ACCESSORIES

LED Strip Pg. 398  
026.267 DRIVER ON/OFF SLIM max60W 24Vdc  
026.268 DRIVER ON/OFF SLIM max100W 24Vdc  
026.269 DRIVER ON/OFF SLIM max150W 24Vdc

LED= MAX 20W/m



3,9 Kg

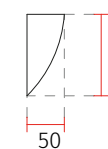
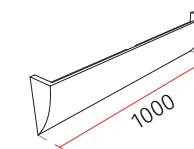

NEW 2635A

#### DATI TECNICI / TECHNICAL DATA

2635B-00 L 1000 Senza Testate / Without endcaps / Ohne Endkappen / Sans tête de fermeture

#### ACCESSORI / ACCESSORIES

LED Strip Pg. 398  
TGC Taglio a misura / Custom Cut / Zuschnitt / Coupe personnalisée  
026.267 DRIVER ON/OFF SLIM max60W 24Vdc  
026.268 DRIVER ON/OFF SLIM max100W 24Vdc  
026.269 DRIVER ON/OFF SLIM max150W 24Vdc

LED= MAX 20W/m



3,9 Kg

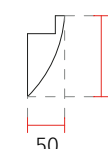
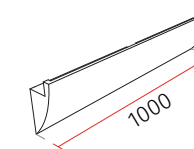

NEW 2635B

#### DATI TECNICI / TECHNICAL DATA

2635C-00 L 1000 Aperta a Destra / Open on the right / Nach rechts geöffnet / Ouvert à droite

#### ACCESSORI / ACCESSORIES

LED Strip Pg. 398  
TGC Taglio a misura / Custom Cut / Zuschnitt / Coupe personnalisée  
026.267 DRIVER ON/OFF SLIM max60W 24Vdc  
026.268 DRIVER ON/OFF SLIM max100W 24Vdc  
026.269 DRIVER ON/OFF SLIM max150W 24Vdc

LED= MAX 20W/m



3,9 Kg

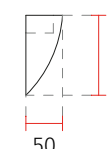
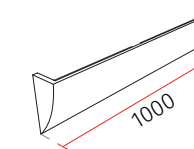

NEW 2635C

#### DATI TECNICI / TECHNICAL DATA

2635D-00 L 1000 Aperta a Sinistra / Open on the left / Nach links geöffnet / Ouvert à gauche

#### ACCESSORI / ACCESSORIES

LED Strip Pg. 398  
TGC Taglio a misura / Custom Cut / Zuschnitt / Coupe personnalisée  
026.267 DRIVER ON/OFF SLIM max60W 24Vdc  
026.268 DRIVER ON/OFF SLIM max100W 24Vdc  
026.269 DRIVER ON/OFF SLIM max150W 24Vdc

LED= MAX 20W/m



3,9 Kg

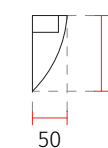
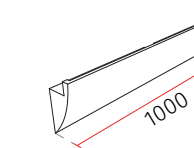

NEW 2635D

DE Die Masse sind in mm, mit einer Tolleranz von +/- 1-2 mm ausgedrückt, Die Firma behält sich das Recht vor ohne Voranmeldung Änderungen an den Werkstoffen, am Design, am Stil und an der Färbung vorzunehmen.  
FR Mesures en mm, tolérance +/- 1/2 mm. La société se réserve le droit de modifier sans préavis les détails techniques, les matériaux, le design, le style et les couleurs.

# A PARETE

## Wall lighting

## Wandleuchten

## Appliques

CRISTALY®  
ALUMITE®

made in Italy

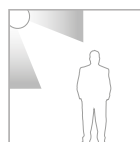

### 2636A - 2636B - 2636C - 2636D:

Nella Confezione di ogni singolo articolo viene fornito:  
- Profilo in CRISTALY®  
- Dissipatore/i in ALUMITE® e schermo in metacrilato opalino goffrato;  
STRIP LED 9010 DA ORDINARE SEPARATAMENTE

EN Included in the packaging of each article:  
- CRISTALY® profile  
- ALUMITE® heat diffuser and Screen in opal methacrylate;  
STRIP LED 9010 TO BE ORDERED SEPARATELY.

DE In der Verpackung der einzelnen Artikel ist inbegriffen:  
- CRISTALY® Profil  
- Eingebauter ALUMITE® Wärmeableiter und Abdeckung aus Opal-Methacrylat;  
LED STRIP 9010 SEPARAT ZU BESTELLEN.

FR Dans le paquet de chaque article est inclus:  
- Profil en CRISTALY®;  
- Dissipateur en ALUMITE® et couverture opal en methacrylate;  
RUBAN LED 9010 A' COMMANDER SEPARÉMENT

IT Misure espresse in mm, tolleranza +/- 1-2 mm. L'azienda si riserva la facoltà di apportare variazioni di dati caratteristici, materiali, design, stili, tonalità, senza alcun preavviso.  
EN Measures in mm, tolerance +/- 1/2 mm. The company reserves the right to carry out variations to technical details, materials, design, style, colors with no previous notice.

#### DATI TECNICI / TECHNICAL DATA

2636A-00 L 1000 Con Testate / With endcaps / Mit Endkappen / Avec tête de fermeture

#### ACCESSORI / ACCESSORIES

LED Strip Pg. 398  
026.267 DRIVER ON/OFF SLIM max60W 24Vdc  
026.268 DRIVER ON/OFF SLIM max100W 24Vdc  
026.269 DRIVER ON/OFF SLIM max150W 24Vdc

LED= MAX 2x20W/m



3,8 Kg

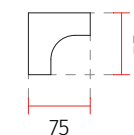
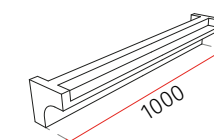

NEW 2636A



#### DATI TECNICI / TECHNICAL DATA

2636B-00 L 1000 Senza Testate / Without endcaps / Ohne Endkappen / Sans tête de fermeture

#### ACCESSORI / ACCESSORIES

LED Strip Pg. 398  
TGC Taglio a misura / Custom Cut / Zuschnitt / Coupe personnalisée  
026.267 DRIVER ON/OFF SLIM max60W 24Vdc  
026.268 DRIVER ON/OFF SLIM max100W 24Vdc  
026.269 DRIVER ON/OFF SLIM max150W 24Vdc

LED= MAX 2x20W/m



3,8 Kg

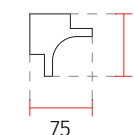
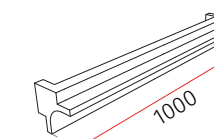

NEW 2636B



#### DATI TECNICI / TECHNICAL DATA

2636C-00 L 1000 Aperta a Destra / Open on the right / Nach rechts geöffnet / Ouvert à droite

#### ACCESSORI / ACCESSORIES

LED Strip Pg. 398  
TGC Taglio a misura / Custom Cut / Zuschnitt / Coupe personnalisée  
026.267 DRIVER ON/OFF SLIM max60W 24Vdc  
026.268 DRIVER ON/OFF SLIM max100W 24Vdc  
026.269 DRIVER ON/OFF SLIM max150W 24Vdc

LED= MAX 2x20W/m



3,8 Kg

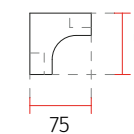
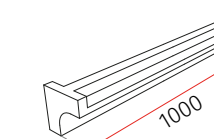

NEW 2636C



#### DATI TECNICI / TECHNICAL DATA

2636D-00 L 1000 Aperta a Sinistra / Open on the left / Nach links geöffnet / Ouvert à gauche

#### ACCESSORI / ACCESSORIES

LED Strip Pg. 398  
TGC Taglio a misura / Custom Cut / Zuschnitt / Coupe personnalisée  
026.267 DRIVER ON/OFF SLIM max60W 24Vdc  
026.268 DRIVER ON/OFF SLIM max100W 24Vdc  
026.269 DRIVER ON/OFF SLIM max150W 24Vdc

LED= MAX 2x20W/m



3,8 Kg

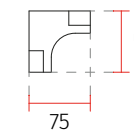
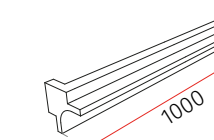

NEW 2636D



DE Die Masse sind in mm, mit einer Tolleranz von +/- 1-2 mm ausgedrückt, Die Firma behält sich das Recht vor ohne Voranmeldung Änderungen an den Werkstoffen, am Design, am Stil und an der Färbung vorzunehmen.  
FR Mesures en mm, tolérance +/- 1/2 mm. La société se réserve le droit de modifier sans préavis les détails techniques, les matériaux, le design, le style et les couleurs.

# A PARETE

## Wall lighting

## Wandleuchten

## Appliques

CRISTALY®

made in Italy

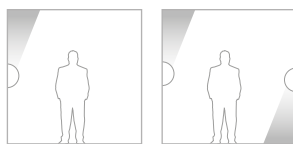

2546



2452/2453:  
MAX 55mm



IP20

Art. 2452 - Private house - Nantes, France



IT Misure espresse in mm, tolleranza +/- 1-2 mm. L'azienda si riserva la facoltà di apportare variazioni di dati caratteristici, materiali, design, stili, tonalità, senza alcun preavviso.  
EN Measures in mm, tolerance +/- 1/2 mm. The company reserves the right to carry out variations to technical details, materials, design, style, colors with no previous notice.

### DATI TECNICI / TECHNICAL DATA

2452-35 GU10 Ø50 MAX 10W-240V

### ACCESSORI / ACCESSORIES

021.231 Portalampada / Lampholder / Lampenfassung / Source GU5.3

2452  
FINITURE SU RICHIESTA / FINISHES ON DEMAND  
OBERFLÄCHENVERARBEITUNGEN AUF NACHFRAGE / FINITIONS SUR DEMANDE:

390  
CORTEN

391  
OSSIDO  
OXIDE



0,4 Kg

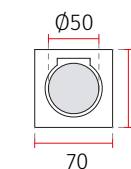

2452



### DATI TECNICI / TECHNICAL DATA

2453-35 GU10 Ø50 MAX 10W-240V

### ACCESSORI / ACCESSORIES

021.231 Portalampada / Lampholder / Lampenfassung / Source GU5.3



0,3 Kg

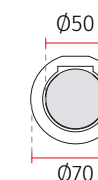

2453



### DATI TECNICI / TECHNICAL DATA

2546-35 GU10 Ø50 MAX 10W-240V

### ACCESSORI / ACCESSORIES

021.231 Portalampada / Lampholder / Lampenfassung / Source GU5.3

2546  
FINITURE SU RICHIESTA / FINISHES ON DEMAND  
OBERFLÄCHENVERARBEITUNGEN AUF NACHFRAGE / FINITIONS SUR DEMANDE:

390  
CORTEN

391  
OSSIDO  
OXIDE



0,5 Kg

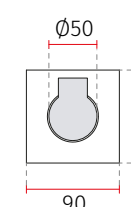

2546



### DATI TECNICI / TECHNICAL DATA

2547-35 GU10 Ø50 MAX 10W-240V

### ACCESSORI / ACCESSORIES

021.231 Portalampada / Lampholder / Lampenfassung / Source GU5.3



0,5 Kg

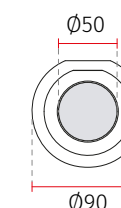

2547



DE Die Masse sind in mm, mit einer Tolleranz von +/- 1-2 mm ausgedrückt, Die Firma behält sich das Recht vor ohne Voranmeldung Änderungen an den Werkstoffen, am Design, am Stil und an der Färbung vorzunehmen.  
FR Mesures en mm, tolérance +/- 1/2 mm. La société se réserve le droit de modifier sans préavis les détails techniques, les matériaux, le design, le style et les couleurs.

# A PARETE

## Wall lighting

## Wandleuchten

## Appliques

CONCRETE<sup>®</sup>  
indoor

made in Italy

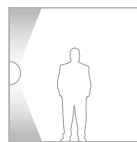

### DATI TECNICI / TECHNICAL DATA

2455-41	E27 52W-240V L 180mm Ø45
2455-3072	LED 18W-220-240V-2700lm-3000°K-CRI85
2455-2772	LED 18W-220-240V-2550lm-2700°K-CRI85
2455-4072	LED 18W-220-240V-2850lm-4000°K-CRI85
2455-3072T	DIM LED* 18W-220-240V-2700lm-3000°K-CRI85
2455-2772T	DIM LED* 18W-220-240V-2550lm-2700°K-CRI85
2455-4072T	DIM LED* 18W-220-240V-2850lm-4000°K-CRI85

\* Alimentatore dimmerabile a taglio di fase / Dimmable phase cut power supply / Dimmbare Phasenanschnitt-Betriebsgerät / Alimentation dimmable à coupure de phase

2455



Art. 2495 - Private house - Vicenza, Italy



### DATI TECNICI / TECHNICAL DATA

2457-41	E27 52W-240V L 130mm
2457-3057	LED 9W-220-240V-1350lm-3000°K-CRI85
2457-2757	LED 9W-220-240V-1300lm-2700°K-CRI85
2457-4057	LED 9W-220-240V-1400lm-4000°K-CRI85
2457-3057T	DIM LED* 9W-220-240V-1350lm-3000°K-CRI85
2457-2757T	DIM LED* 9W-220-240V-1300lm-2700°K-CRI85
2457-4057T	DIM LED* 9W-220-240V-1400lm-4000°K-CRI85

\* Alimentatore dimmerabile a taglio di fase / Dimmable phase cut power supply / Dimmbare Phasenanschnitt-Betriebsgerät / Alimentation dimmable à coupure de phase

2457

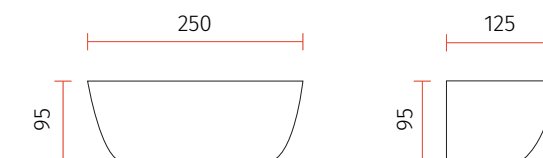

### DATI TECNICI / TECHNICAL DATA

2495-3082	LED 12W-220-240V-1800lm-3000°K-CRI85
2495-2782	LED 12W-220-240V-1700lm-2700°K-CRI85
2495-4082	LED 12W-220-240V-1900lm-4000°K-CRI85
2495-3082T	DIM LED* 12W-220-240V-1800lm-3000°K-CRI85
2495-2782T	DIM LED* 12W-220-240V-1700lm-2700°K-CRI85
2495-4082T	DIM LED* 12W-220-240V-1900lm-4000°K-CRI85

\* Alimentatore dimmerabile a taglio di fase / Dimmable phase cut power supply / Dimmbare Phasenanschnitt-Betriebsgerät / Alimentation dimmable à coupure de phase

2495



Art. 2455



Diffusore in vetro  
Glass diffuser  
Glasabdeckung  
Diffuseur en verre

Art. 2457



Diffusore in vetro  
Glass diffuser  
Glasabdeckung  
Diffuseur en verre

Art. 2495



IT Misure espresse in mm, tolleranza +/- 1-2 mm. L'azienda si riserva la facoltà di apportare variazioni di dati caratteristici, materiali, design, stili, tonalità, senza alcun preavviso.  
EN Measures in mm, tolerance +/- 1/2 mm. The company reserves the right to carry out variations to technical details, materials, design, style, colors with no previous notice.

DE Die Masse sind in mm, mit einer Tolleranz von +/- 1-2 mm ausgedrückt, Die Firma behält sich das Recht vor ohne Voranmeldung Änderungen an den Werkstoffen, am Design, am Stil und an der Färbung vorzunehmen.  
FR Mesures en mm, tolérance +/- 1/2 mm. La société se réserve le droit de modifier sans préavis les détails techniques, les matériaux, le design, le style et les couleurs.

**A PARETE**  
Wall lighting  
Wandleuchten  
Appliques

CONCRETE<sup>®</sup>  
indoor

made in Italy



**DATI TECNICI / TECHNICAL DATA**

2456-41	E27 52W-240V L 180mm
2456-3054	LED 18W-220-240V-2700lm-3000°K-CRI85
2456-2754	LED 18W-220-240V-2550lm-2700°K-CRI85
2456-4054	LED 18W-220-240V-2850lm-4000°K-CRI85
2456-3054T	DIM LED* 18W-220-240V-2700lm-3000°K-CRI85
2456-2754T	DIM LED* 18W-220-240V-2550lm-2700°K-CRI85
2456-4054T	DIM LED* 18W-220-240V-2850lm-4000°K-CRI85

\* Alimentatore dimmerabile a taglio di fase / Dimmable phase cut power supply /  
Dimmbare Phasenanschnitt-Betriebsgerät / Alimentation dimmable à coupure de phase



**2456**

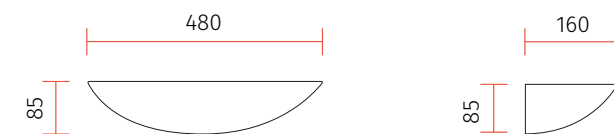

Art. 2458 - Private house - Patras, Greece



**DATI TECNICI / TECHNICAL DATA**

2458-3054	LED 18W-220-240V-2700lm-3000°K-CRI85
2458-2754	LED 18W-220-240V-2550lm-2700°K-CRI85
2458-4054	LED 18W-220-240V-2850lm-4000°K-CRI85
2458-3054T	DIM LED* 18W-220-240V-2700lm-3000°K-CRI85
2458-2754T	DIM LED* 18W-220-240V-2550lm-2700°K-CRI85
2458-4054T	DIM LED* 18W-220-240V-2850lm-4000°K-CRI85

\* Alimentatore dimmerabile a taglio di fase / Dimmable phase cut power supply /  
Dimmbare Phasenanschnitt-Betriebsgerät / Alimentation dimmable à coupure de phase

**2458**

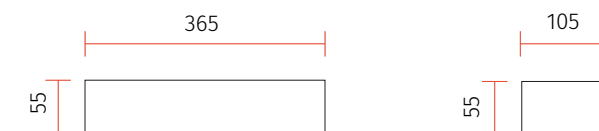

IT Misure espresse in mm, tolleranza +/- 1-2 mm. L'azienda si riserva la facoltà di apportare variazioni di dati caratteristici, materiali, design, stili, tonalità, senza alcun preavviso.  
EN Measures in mm, tolerance +/- 1/2 mm. The company reserves the right to carry out variations to technical details, materials, design, style, colors with no previous notice.

DE Die Masse sind in mm, mit einer Tolleranz von +/- 1-2 mm ausgedrückt, Die Firma behält sich das Recht vor ohne Voranmeldung Änderungen an den Werkstoffen, am Design, am Stil und an der Färbung vorzunehmen.  
FR Mesures en mm, tolérance +/- 1/2 mm. La société se réserve le droit de modifier sans préavis les détails techniques, les matériaux, le design, le style et les couleurs.



# A PARETE

## Wall lighting

## Wandleuchten

## Appliques

CRISTALY<sup>®</sup>  
CONCRETE<sup>®</sup>  
indoor

made in Italy

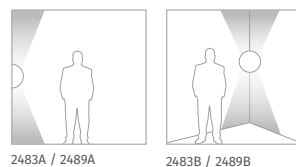

DATI TECNICI / TECHNICAL DATA	
2483A-3080	LED 18W-220-240V-2700lm-3000°K-CRI85
2483A-2780	LED 18W-220-240V-2550lm-2700°K-CRI85
2483A-4080	LED 18W-220-240V-2850lm-4000°K-CRI85
2483A-3080T	DIM LED* 18W-220-240V-2700lm-3000°K-CRI85
2483A-2780T	DIM LED* 18W-220-240V-2550lm-2700°K-CRI85
2483A-4080T	DIM LED* 18W-220-240V-2850lm-4000°K-CRI85

\* Alimentatore dimmerabile a taglio di fase / Dimmable phase cut power supply / Dimmbare Phasenanschnitt-Betriebsgerät / Alimentation dimmable à coupure de phase

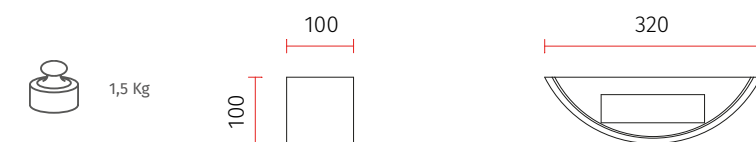

# 2483A

DATI TECNICI / TECHNICAL DATA	
2483B-3080	LED 18W-220-240V-2700lm-3000°K-CRI85
2483B-2780	LED 18W-220-240V-2550lm-2700°K-CRI85
2483B-4080	LED 18W-220-240V-2850lm-4000°K-CRI85
2483B-3080T	DIM LED* 18W-220-240V-2700lm-3000°K-CRI85
2483B-2780T	DIM LED* 18W-220-240V-2550lm-2700°K-CRI85
2483B-4080T	DIM LED* 18W-220-240V-2850lm-4000°K-CRI85

\* Alimentatore dimmerabile a taglio di fase / Dimmable phase cut power supply / Dimmbare Phasenanschnitt-Betriebsgerät / Alimentation dimmable à coupure de phase

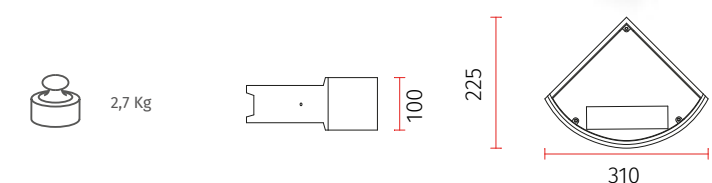

# 2483B

DATI TECNICI / TECHNICAL DATA	
2489A-3080	LED 18W-220-240V-2700lm-3000°K-CRI85
2489A-2780	LED 18W-220-240V-2550lm-2700°K-CRI85
2489A-4080	LED 18W-220-240V-2850lm-4000°K-CRI85
2489A-3080T	DIM LED* 18W-220-240V-2700lm-3000°K-CRI85
2489A-2780T	DIM LED* 18W-220-240V-2550lm-2700°K-CRI85
2489A-4080T	DIM LED* 18W-220-240V-2850lm-4000°K-CRI85

\* Alimentatore dimmerabile a taglio di fase / Dimmable phase cut power supply / Dimmbare Phasenanschnitt-Betriebsgerät / Alimentation dimmable à coupure de phase

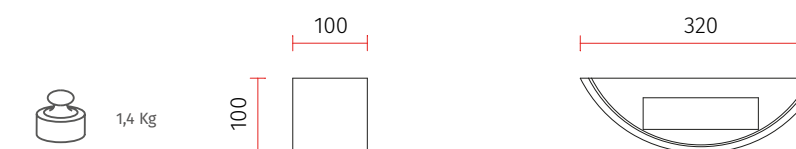

# 2489A

DATI TECNICI / TECHNICAL DATA	
2489B-3080	LED 18W-220-240V-2700lm-3000°K-CRI85
2489B-2780	LED 18W-220-240V-2550lm-2700°K-CRI85
2489B-4080	LED 18W-220-240V-2850lm-4000°K-CRI85
2489B-3080T	DIM LED* 18W-220-240V-2700lm-3000°K-CRI85
2489B-2780T	DIM LED* 18W-220-240V-2550lm-2700°K-CRI85
2489B-4080T	DIM LED* 18W-220-240V-2850lm-4000°K-CRI85

\* Alimentatore dimmerabile a taglio di fase / Dimmable phase cut power supply / Dimmbare Phasenanschnitt-Betriebsgerät / Alimentation dimmable à coupure de phase

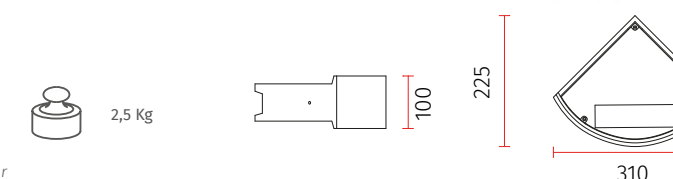

# 2489B

Art. 2483B - Private studio - Vicenza, Italy



Art. 2483A

Art. 2489A

Art. 2489B



IT Misure espresse in mm, tolleranza +/- 1-2 mm. L'azienda si riserva la facoltà di apportare variazioni di dati caratteristici, materiali, design, stili, tonalità, senza alcun preavviso.  
EN Measures in mm, tolerance +/- 1/2 mm. The company reserves the right to carry out variations to technical details, materials, design, style, colors with no previous notice.

DE Die Masse sind in mm, mit einer Tolleranz von +/- 1-2 mm ausgedrückt, Die Firma behält sich das Recht vor ohne Voranmeldung Änderungen an den Werkstoffen, am Design, am Stil und an der Färbung vorzunehmen.  
FR Mesures en mm, tolérance +/- 1/2 mm. La société se réserve le droit de modifier sans préavis les détails techniques, les matériaux, le design, le style et les couleurs.

# A PARETE

## Wall lighting

## Wandleuchten

## Appliques

CRISTALY®

made in Italy



CASAMBI Pg.408

FINITURE SU RICHIESTA / FINISHES ON DEMAND  
OBERFLÄCHENVERARBEITUNGEN AUF NACHFRAGE / FINITIONS SUR DEMANDE:

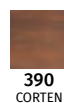

390  
CORTEN



391  
OSSIDO  
OXIDE

Art. 2493C - Private house - Savona, Italy



L'alimentatore dimmerabile non può essere installato nell'applicazione ma deve essere installato in una scatola di derivazione remota.

EN The dimmable driver shall not be installed in the wall lamp, but on a remote box.

DE Das dimmbare Betriebsgerät darf nicht in der Wandleuchte installiert werden, sondern im Schaltkasten

FR L'alimentation dimmable ne doit pas être installé dans l'applique, mais dans une boîte électrique

IT Misure espresse in mm, tolleranza +/- 1-2 mm. L'azienda si riserva la facoltà di apportare variazioni di dati caratteristici, materiali, design, stili, tonalità, senza alcun preavviso.  
EN Measures in mm, tolerance +/- 1/2 mm. The company reserves the right to carry out variations to technical details, materials, design, style, colors with no previous notice.

### DATI TECNICI / TECHNICAL DATA

2493A-3003	LED 23,5W-24Vdc-2650lm-3000°K-CRI90
2493A-2703	LED 23,5W-24Vdc-2550lm-2700°K-CRI90
2493A-4003	LED 23,5W-24Vdc-2800lm-4000°K-CRI90
026.267A	DRIVER ON/OFF 30W 24V
026.209	DRIVER DIM PUSH/1-10V 60W 24V
026.190+026.261	DRIVER DIM PUSH/0-10V/DALI 150W 24V
026.190+026.262	DRIVER DIM PUSH/0-10V/DALI 240W 24V

### ACCESSORI / ACCESSORIES

099.142	Pg.415 Kit emergenza / Emergency Kit
---------	--------------------------------------



1,9 Kg

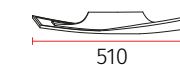

# 2493A

### DATI TECNICI / TECHNICAL DATA

2493B-3003	LED 39W-24Vdc-4500lm-3000°K-CRI90
2493B-2703	LED 39W-24Vdc-4300lm-2700°K-CRI90
2493B-4003	LED 39W-24Vdc-4700lm-4000°K-CRI90
026.267	DRIVER ON/OFF 60W 24V
026.209	DRIVER DIM PUSH/1-10V 60W 24V
026.190+026.261	DRIVER DIM PUSH/0-10V/DALI 150W 24V
026.190+026.262	DRIVER DIM PUSH/0-10V/DALI 240W 24V

### ACCESSORI / ACCESSORIES

099.142	Pg.415 Kit emergenza / Emergency Kit
---------	--------------------------------------



3,1 Kg

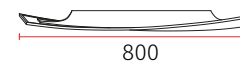

# 2493B

### DATI TECNICI / TECHNICAL DATA

2493C-3003	LED 60W-24Vdc-6900lm-3000°K-CRI90
2493C-2703	LED 60W-24Vdc-6600lm-2700°K-CRI90
2493C-4003	LED 60W-24Vdc-7200lm-4000°K-CRI90
026.267	DRIVER ON/OFF 60W 24V
026.209	DRIVER DIM PUSH/1-10V 60W 24V
026.190+026.261	DRIVER DIM PUSH/0-10V/DALI 150W 24V
026.190+026.262	DRIVER DIM PUSH/0-10V/DALI 240W 24V

### ACCESSORI / ACCESSORIES

099.142	Pg.415 Kit emergenza / Emergency Kit
---------	--------------------------------------



5,5 Kg

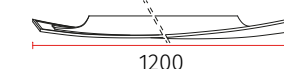

# 2493C

### DATI TECNICI / TECHNICAL DATA

2493D-3003	LED 23,5W-24Vdc-2650lm-3000°K-CRI90
2493D-2703	LED 23,5W-24Vdc-2550lm-2700°K-CRI90
2493D-4003	LED 23,5W-24Vdc-2800lm-4000°K-CRI90
026.259	DRIVER ON/OFF 36W 24V
026.209	DRIVER DIM PUSH/1-10V 60W 24V
026.190+026.261	DRIVER DIM PUSH/0-10V/DALI 150W 24V
026.190+026.262	DRIVER DIM PUSH/0-10V/DALI 240W 24V

### ACCESSORI / ACCESSORIES

099.142	Pg.415 Kit emergenza / Emergency Kit
---------	--------------------------------------



1,8 Kg

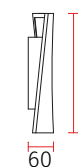
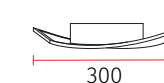

# 2493D

DE Die Masse sind in mm, mit einer Tolleranz von +/- 1-2 mm ausgedrückt, Die Firma behält sich das Recht vor ohne Voranmeldung Änderungen an den Werkstoffen, am Design, am Stil und an der Färbung vorzunehmen.  
FR Mesures en mm, tolérance +/- 1/2 mm. La société se réserve le droit de modifier sans préavis les détails techniques, les matériaux, le design, le style et les couleurs.

**A PARETE**  
Wall lighting  
Wandleuchten  
Appliques

CERAMICA ROTO

made in Italy



Art. 2503



Art. 2504



Art. 2498



**DATI TECNICI / TECHNICAL DATA**

2500-30157	LED 9W-220-240V-1200lm-3000°K-CRI90
2500-27157	LED 9W-220-240V-1150lm-2700°K-CRI90
2500-40157	LED 9W-220-240V-1250lm-4000°K-CRI90
2500-30157T	DIM LED*9W-220-240V-1200lm-3000°K-CRI90
2500-27157T	DIM LED*9W-220-240V-1150lm-2700°K-CRI90
2500-40157T	DIM LED* 9W-220-240V-1250lm-4000°K-CRI90

\* Alimentatore dimmerabile a taglio di fase / Dimmable phase cut power supply / Dimmbare Phasenanschnitt-Betriebsgerät / Alimentation dimmable à coupure de phase

Designer  
**Henry&Co**  
>SPIRAGLIO

**DATI TECNICI / TECHNICAL DATA**

2503-3080	LED 18W-220-240V-2700lm-3000°K-CRI85
2503-2780	LED 18W-220-240V-2550lm-2700°K-CRI85
2503-4080	LED 18W-220-240V-2850lm-4000°K-CRI85
2503-3080T	DIM LED* 18W-220-240V-2700lm-3000°K-CRI85
2503-2780T	DIM LED* 18W-220-240V-2550lm-2700°K-CRI85
2503-4080T	DIM LED* 18W-220-240V-2850lm-4000°K-CRI85

\* Alimentatore dimmerabile a taglio di fase / Dimmable phase cut power supply / Dimmbare Phasenanschnitt-Betriebsgerät / Alimentation dimmable à coupure de phase

**DATI TECNICI / TECHNICAL DATA**

2504-3048	LED 12W-220-240V-1800lm-3000°K-CRI85
2504-2748	LED 12W-220-240V-1700lm-2700°K-CRI85
2504-4048	LED 12W-220-240V-1900lm-4000°K-CRI85
2504-3048T	DIM LED* 12W-220-240V-1800lm-3000°K-CRI85
2504-2748T	DIM LED* 12W-220-240V-1700lm-2700°K-CRI85
2504-4048T	DIM LED* 12W-220-240V-1900lm-4000°K-CRI85

\* Alimentatore dimmerabile a taglio di fase / Dimmable phase cut power supply / Dimmbare Phasenanschnitt-Betriebsgerät / Alimentation dimmable à coupure de phase

**NEW 2500**



2 Kg

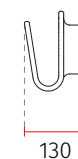
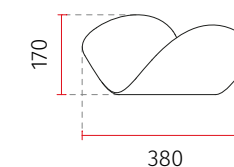

**NEW 2503**



1,65 Kg

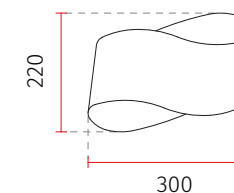

**NEW 2504**



2 Kg

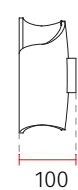
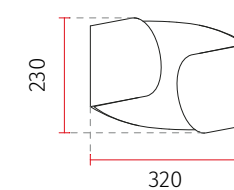

**2498 NEW**



1,6 Kg

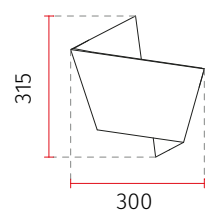

**DATI TECNICI / TECHNICAL DATA**

2498-3080	LED 18W-220-240V-2700lm-3000°K-CRI85
2498-2780	LED 18W-220-240V-2550lm-2700°K-CRI85
2498-4080	LED 18W-220-240V-2850lm-4000°K-CRI85
2498-3080T	DIM LED* 18W-220-240V-2700lm-3000°K-CRI85
2498-2780T	DIM LED* 18W-220-240V-2550lm-2700°K-CRI85
2498-4080T	DIM LED* 18W-220-240V-2850lm-4000°K-CRI85

\* Alimentatore dimmerabile a taglio di fase / Dimmable phase cut power supply / Dimmbare Phasenanschnitt-Betriebsgerät / Alimentation dimmable à coupure de phase

IT Misure espresse in mm, tolleranza +/- 1-2 mm. L'azienda si riserva la facoltà di apportare variazioni di dati caratteristici, materiali, design, stili, tonalità, senza alcun preavviso.  
EN Measures in mm, tolerance +/- 1/2 mm. The company reserves the right to carry out variations to technical details, materials, design, style, colors with no previous notice.

DE Die Masse sind in mm, mit einer Tolleranz von +/- 1-2 mm ausgedrückt, Die Firma behält sich das Recht vor ohne Voranmeldung Änderungen an den Werkstoffen, am Design, am Stil und an der Färbung vorzunehmen.  
FR Mesures en mm, tolérance +/- 1/2 mm. La société se réserve le droit de modifier sans préavis les détails techniques, les matériaux, le design, le style et les couleurs.



# ESTETICA E FUNZIONALITÀ



ARTIGIANALE  
HANDMADE

DECORATIVO  
DECORATIVE

MODERNO  
MODERN

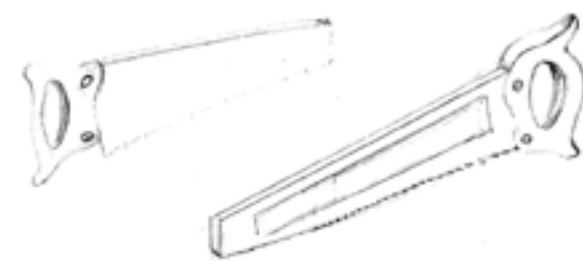

2516A SAW



2516C SPOON



2516D FORK



2516F SPANNER



2516M/Q MOKA

Gli utensili non si nascondono più, anzi, diventano complementi d'arredo e utili all'illuminazione. Funzionali, ma soprattutto esteticamente interessanti. Il CRISTALY® prende vita nella quotidianità dei gesti.

EN The tools are no longer hidden, they become furnishing accessories that are useful for lighting. Functional, but above all aesthetically interesting. CRISTALY® comes to life with everyday life gestures.

DE Die Werkzeuge sind nicht mehr verdeckt, sondern dienen als Einrichtungszubehör für die Beleuchtung. Sie sind funktionell und optisch sehr interessant. CRISTALY® nimmt Gestalt an bei den Gesten des täglichen Lebens.

FR Les ustensiles ne se cachent plus, ils deviennent même une partie intégrante de l'ameublement et de l'éclairage. Fonctionnels, mais surtout esthétiquement intéressants. Le CRISTALY® prend vie dans les gestes quotidiens.

**A PARETE**  
Wall lighting  
Wandleuchten  
Appliques

CRISTALY® made in Italy

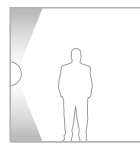

CASAMBI Pg.408 CE III C.V. [M] IP20

**NEW 2516F**



0,35 Kg

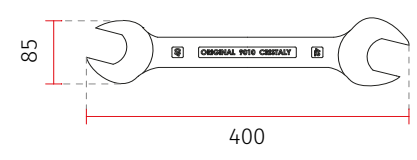

**DATI TECNICI / TECHNICAL DATA**

2516F-3003	LED 6,5W-24Vdc-750lm-3000°K-CRI90
2516F-2703	LED 6,5W-24Vdc-700lm-2700°K-CRI90
2516F-4003	LED 6,5W-24Vdc-790lm-4000°K-CRI90
026.258	DRIVER ON/OFF 12W 24V
026.259	DRIVER ON/OFF 36W 24V
026.260	DRIVER ON/OFF 60W 24V
026.261	DRIVER ON/OFF 150W 24V
026.262	DRIVER ON/OFF 240W 24V
026.219	DRIVER DIM PUSH/0-10V/DALI 21.6W 24V
026.209	DRIVER DIM PUSH/1-10V 60W 24V
026.190+026.261	DRIVER DIM PUSH/0-10V/DALI 150W 24V
026.190+026.262	DRIVER DIM PUSH/0-10V/DALI 240W 24V

**ACCESSORI / ACCESSORIES**

099.142	Pg.415 Kit emergenza / Emergency Kit
---------	--------------------------------------

**DATI TECNICI / TECHNICAL DATA**

2516M-3045	LED 12W-220-240V-1350lm-3000°K-CRI90
2516M-2745	LED 12W-220-240V-1300lm-2700°K-CRI90
2516M-4045	LED 12W-220-240V-1400lm-4000°K-CRI90

**ACCESSORI / ACCESSORIES**

099.142	Pg.415 Kit emergenza / Emergency Kit
---------	--------------------------------------

**NEW 2516M**



1,35 Kg

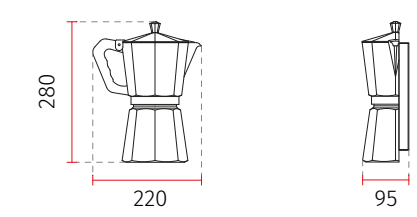

**DATI TECNICI / TECHNICAL DATA**

2516Q-35	GU10 ø50 MAX 10W-240V
----------	-----------------------

**ACCESSORI / ACCESSORIES**

5508A-00	Rosone ad appoggio / Ceiling Rose / Deckenrossette / Rosace Plafond Ø130x25mm
5505A-00	Rosone a scomparsa / Recessed Ceiling Rose / Einbau/Deckenrossette / Rosace encastré
5505B-00	Rosone a scomparsa / Recessed Ceiling Rose / Einbau/Deckenrossette / Rosace encastré
5505C-00	Rosone a scomparsa / Recessed Ceiling Rose / Einbau/Deckenrossette / Rosace encastré
5505D-00	Rosone a scomparsa / Recessed Ceiling Rose / Einbau/Deckenrossette / Rosace encastré
5505E-00	Rosone a scomparsa / Recessed Ceiling Rose / Einbau/Deckenrossette / Rosace encastré
020.314	Pg.381 Cavi colorati / Coloured cables / farbigen Kabel / câbles colorés

**NEW 2516Q**



0,8 Kg

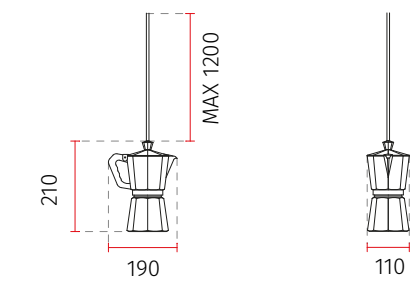

POSSIBILITÀ DI INSTALLAZIONE CON CAVI COLORATI / INSTALLATION WITH COLOURED CABLES AVAILABLE / INSTALLATION MIT FARBIGEN KABELN VERFÜGBAR / INSTALLATION AVEC CÂBLES COLORES DISPONIBLES:



DE Die Masse sind in mm, mit einer Tolleranz von +/- 1-2 mm ausgedrückt, Die Firma behält sich das Recht vor ohne Voranmeldung Änderungen an den Werkstoffen, am Design, am Stil und an der Färbung vorzunehmen.  
FR Mesures en mm, tolérance +/- 1/2 mm. La société se réserve le droit de modifier sans préavis les détails techniques, les matériaux, le design, le style et les couleurs.

**2516A NEW**



0,75 Kg

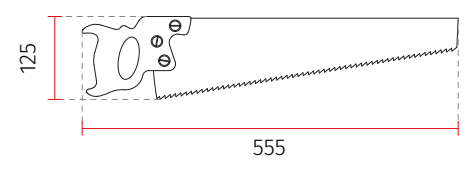

25

**DATI TECNICI / TECHNICAL DATA**

2516A-3003	LED 9,5W-24Vdc-1100lm-3000°K-CRI90
2516A-2703	LED 9,5W-24Vdc-1050lm-2700°K-CRI90
2516A-4003	LED 9,5W-24Vdc-1150lm-4000°K-CRI90
026.258	DRIVER ON/OFF 12W 24V
026.259	DRIVER ON/OFF 36W 24V
026.260	DRIVER ON/OFF 60W 24V
026.261	DRIVER ON/OFF 150W 24V
026.262	DRIVER ON/OFF 240W 24V
026.219	DRIVER DIM PUSH/0-10V/DALI 21.6W 24V
026.209	DRIVER DIM PUSH/1-10V 60W 24V
026.190+026.261	DRIVER DIM PUSH/0-10V/DALI 150W 24V
026.190+026.262	DRIVER DIM PUSH/0-10V/DALI 240W 24V

**ACCESSORI / ACCESSORIES**

099.142	Pg.415 Kit emergenza / Emergency Kit
---------	--------------------------------------

**2516C NEW**



0,3 Kg

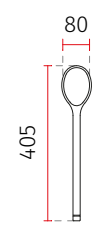

20

**DATI TECNICI / TECHNICAL DATA**

2516C-3002	LED 5.5W-24Vdc-580lm-3000°K-CRI90
2516C-2702	LED 5.5W-24Vdc-550lm-2700°K-CRI90
2516C-4002	LED 5.5W-24Vdc-600lm-4000°K-CRI90
026.258	DRIVER ON/OFF 12W 24V
026.259	DRIVER ON/OFF 36W 24V
026.260	DRIVER ON/OFF 60W 24V
026.219	DRIVER DIM PUSH/0-10V/DALI 21.6W 24V
026.209	DRIVER DIM PUSH/1-10V 60W 24V

**ACCESSORI / ACCESSORIES**

099.142	Pg.415 Kit emergenza / Emergency Kit
---------	--------------------------------------

**2516D NEW**



0,25 Kg

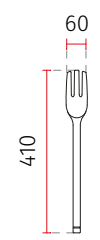

20

**DATI TECNICI / TECHNICAL DATA**

2516D-3002	LED 4.5W-24Vdc-500lm-3000°K-CRI90
2516D-2702	LED 4.5W-24Vdc-475lm-2700°K-CRI90
2516D-4002	LED 4.5W-24Vdc-525lm-4000°K-CRI90
026.258	DRIVER ON/OFF 12W 24V
026.259	DRIVER ON/OFF 36W 24V
026.260	DRIVER ON/OFF 60W 24V
026.219	DRIVER DIM PUSH/0-10V/DALI 21.6W 24V
026.209	DRIVER DIM PUSH/1-10V 60W 24V

**ACCESSORI / ACCESSORIES**

099.142	Pg.415 Kit emergenza / Emergency Kit
---------	--------------------------------------

IT Misure espresse in mm, tolleranza +/- 1-2 mm. L'azienda si riserva la facoltà di apportare variazioni di dati caratteristici, materiali, design, stili, tonalità, senza alcun preavviso.  
EN Measures in mm, tollerance +/- 1/2 mm. The company reserves the right to carry out variations to technical details, materials, design, style, colors with no previous notice.

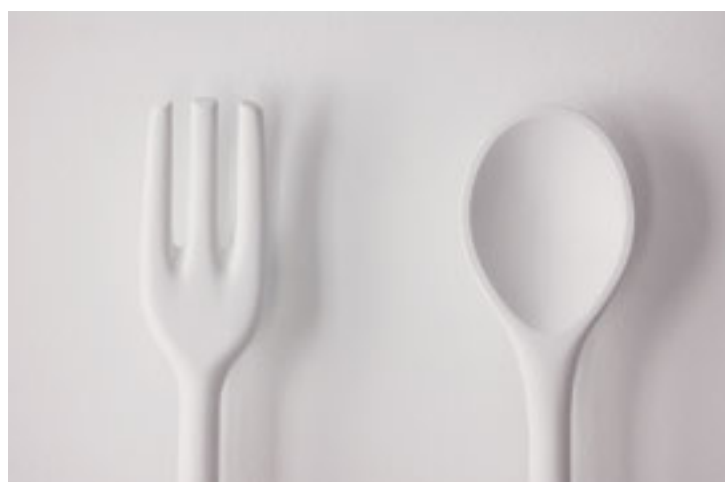

# A PARETE

Wall lighting  
Wandleuchten  
Appliques

CRISTALY®

made in Italy



FINITURE SU RICHIESTA / FINISHES ON DEMAND  
OBERFLÄCHENVERARBEITUNGEN AUF NACHFRAGE / FINITIONS SUR DEMANDE:

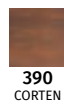

390  
CORTEN



391  
OSSIDO  
OXIDE

Art. 2537 - Private house - Pisa, Italy

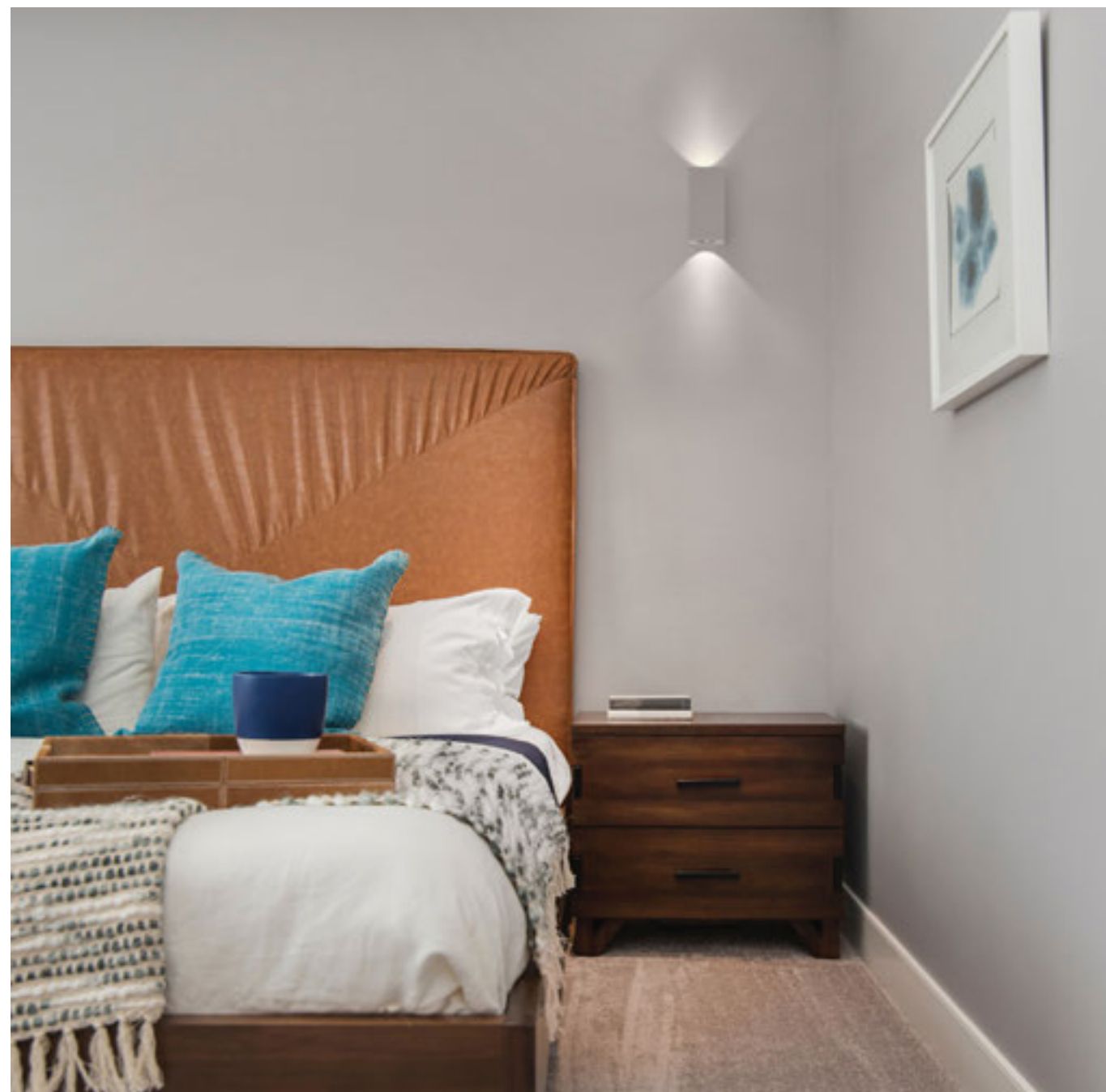

Biemissione  
Dual emission  
Doppelsemission  
Double émission

IT Misure espresse in mm, tolleranza +/- 1-2 mm. L'azienda si riserva la facoltà di apportare variazioni di dati caratteristici, materiali, design, stili, tonalità, senza alcun preavviso.  
EN Measures in mm, tolerance +/- 1/2 mm. The company reserves the right to carry out variations to technical details, materials, design, style, colors with no previous notice.

## DATI TECNICI / TECHNICAL DATA

2536-35 GU10 Ø50 MAX 2x10W-240V

## ACCESSORI / ACCESSORIES

021.231 Portalampada / Lampholder / Lampenfassung / Source GU5.3

2536



0,6 Kg

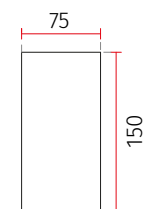
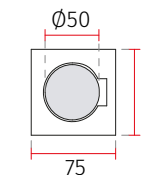

## DATI TECNICI / TECHNICAL DATA

2537-35 GU10 Ø50 MAX 2x10W-240V

## ACCESSORI / ACCESSORIES

021.231 Portalampada / Lampholder / Lampenfassung / Source GU5.3

2537



1 Kg

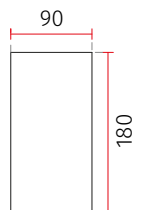
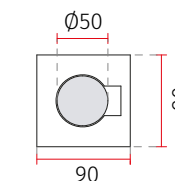

## DATI TECNICI / TECHNICAL DATA

2541-35 GU10 Ø50 MAX 2x10W-240V

## ACCESSORI / ACCESSORIES

021.231 Portalampada / Lampholder / Lampenfassung / Source GU5.3

2541



0,95 Kg

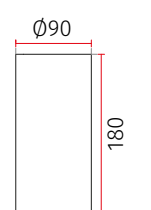
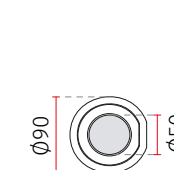

DE Die Masse sind in mm, mit einer Tolleranz von +/- 1-2 mm ausgedrückt, Die Firma behält sich das Recht vor ohne Voranmeldung Änderungen an den Werkstoffen, am Design, am Stil und an der Färbung vorzunehmen.  
FR Mesures en mm, tolérance +/- 1/2 mm. La société se réserve le droit de modifier sans préavis les détails techniques, les matériaux, le design, le style et les couleurs.

# A PARETE

## Wall lighting

## Wandleuchten

## Appliques

CERAMICA 9000

made in Italy



Art. 2608B - Private house - Viterbo, Italy



### DATI TECNICI / TECHNICAL DATA

2603B-41	E27 52W-240V L 150mm
2603B-52	G9 60W-240V L 100mm
2603B-3057	LED 9W-220-240V-1350lm-3000°K-CRI85
2603B-2757	LED 9W-220-240V-1300lm-2700°K-CRI85
2603B-4057	LED 9W-220-240V-1400lm-4000°K-CRI85
2603B-3057T	DIM LED* 9W-220-240V-1350lm-3000°K-CRI85
2603B-2757T	DIM LED* 9W-220-240V-1300lm-2700°K-CRI85
2603B-4057T	DIM LED* 9W-220-240V-1400lm-4000°K-CRI85

\* Alimentatore dimmerabile a taglio di fase / Dimmable phase cut power supply / Dimmbare Phasenanschnitt-Betriebsgerät / Alimentation dimmable à coupure de phase



Diffusore in vetro  
Glass diffuser  
Glasabdeckung  
Diffuseur en verre



# 2603B



0,95 Kg

### DATI TECNICI / TECHNICAL DATA

2604B-41	E27 52W-240V L 150mm
2604B-52	G9 60W-240V L 100mm
2604B-3057	LED 9W-220-240V-1350lm-3000°K-CRI85
2604B-2757	LED 9W-220-240V-1300lm-2700°K-CRI85
2604B-4057	LED 9W-220-240V-1400lm-4000°K-CRI85
2604B-3057T	DIM LED* 9W-220-240V-1350lm-3000°K-CRI85
2604B-2757T	DIM LED* 9W-220-240V-1300lm-2700°K-CRI85
2604B-4057T	DIM LED* 9W-220-240V-1400lm-4000°K-CRI85

\* Alimentatore dimmerabile a taglio di fase / Dimmable phase cut power supply / Dimmbare Phasenanschnitt-Betriebsgerät / Alimentation dimmable à coupure de phase



Diffusore in vetro  
Glass diffuser  
Glasabdeckung  
Diffuseur en verre

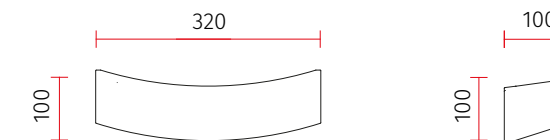

# 2604B



0,95 Kg

### DATI TECNICI / TECHNICAL DATA

2608B-41	E27 52W-240V L 170mm Ø45
2608B-52	G9 2X60W-240V L 100mm
2608B-3060	LED 18W-220-240V-2700lm-3000°K-CRI85
2608B-2760	LED 18W-220-240V-2550lm-2700°K-CRI85
2608B-4060	LED 18W-220-240V-2850lm-4000°K-CRI85
2608B-3060T	DIM LED* 18W-220-240V-2700lm-3000°K-CRI85
2608B-2760T	DIM LED* 18W-220-240V-2550lm-2700°K-CRI85
2608B-4060T	DIM LED* 18W-220-240V-2850lm-4000°K-CRI85

\* Alimentatore dimmerabile a taglio di fase / Dimmable phase cut power supply / Dimmbare Phasenanschnitt-Betriebsgerät / Alimentation dimmable à coupure de phase



Diffusore in vetro  
Glass diffuser  
Glasabdeckung  
Diffuseur en verre

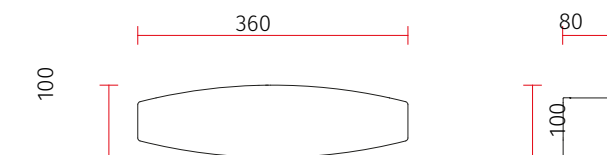

# 2608B



1,35 Kg

# 2603A



### DATI TECNICI / TECHNICAL DATA

2603A-41	E27 52W-240V L 150mm
2603A-52	G9 60W-240V L 100mm
2603A-3057	LED 9W-220-240V-1350lm-3000°K-CRI85
2603A-2757	LED 9W-220-240V-1300lm-2700°K-CRI85
2603A-4057	LED 9W-220-240V-1400lm-4000°K-CRI85
2603A-3057T	DIM LED* 9W-220-240V-1350lm-3000°K-CRI85
2603A-2757T	DIM LED* 9W-220-240V-1300lm-2700°K-CRI85
2603A-4057T	DIM LED* 9W-220-240V-1400lm-4000°K-CRI85

\* Alimentatore dimmerabile a taglio di fase / Dimmable phase cut power supply / Dimmbare Phasenanschnitt-Betriebsgerät / Alimentation dimmable à coupure de phase



0,95 Kg

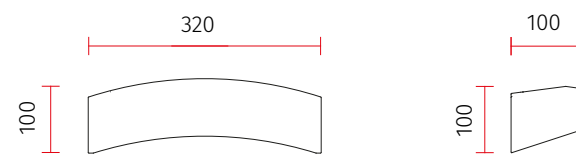

IT Misure espresse in mm, tolleranza +/- 1-2 mm. L'azienda si riserva la facoltà di apportare variazioni di dati caratteristici, materiali, design, stili, tonalità, senza alcun preavviso.  
EN Measures in mm, tolerance +/- 1/2 mm. The company reserves the right to carry out variations to technical details, materials, design, style, colors with no previous notice.

DE Die Masse sind in mm, mit einer Tolleranz von +/- 1-2 mm ausgedrückt, Die Firma behält sich das Recht vor ohne Voranmeldung Änderungen an den Werkstoffen, am Design, am Stil und an der Färbung vorzunehmen.  
FR Mesures en mm, tolérance +/- 1/2 mm. La société se réserve le droit de modifier sans préavis les détails techniques, les matériaux, le design, le style et les couleurs.



# A PARETE

Wall lighting  
Wandleuchten  
Appliques

CERAMICA 9000

made in Italy

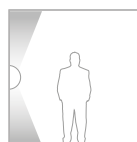

DATI TECNICI / TECHNICAL DATA	
2613B-3048	LED 12W-220-240V-1800lm-3000°K-CRI85
2613B-2748	LED 12W-220-240V-1700lm-2700°K-CRI85
2613B-4048	LED 12W-220-240V-1900lm-4000°K-CRI85
2613B-3048T	DIM LED* 12W-220-240V-1800lm-3000°K-CRI85
2613B-2748T	DIM LED* 12W-220-240V-1700lm-2700°K-CRI85
2613B-4048T	DIM LED* 12W-220-240V-1900lm-4000°K-CRI85

\* Alimentatore dimmerabile a taglio di fase / Dimmable phase cut power supply / Dimmbare Phasenanschnitt-Betriebsgerät / Alimentation dimmable à coupure de phase

Art. 2614B - Private house - Ravenna, Italy



DATI TECNICI / TECHNICAL DATA	
2614B-3048	LED 12W-220-240V-1800lm-3000°K-CRI85
2614B-2748	LED 12W-220-240V-1700lm-2700°K-CRI85
2614B-4048	LED 12W-220-240V-1900lm-4000°K-CRI85
2614B-3048T	DIM LED* 12W-220-240V-1800lm-3000°K-CRI85
2614B-2748T	DIM LED* 12W-220-240V-1700lm-2700°K-CRI85
2614B-4048T	DIM LED* 12W-220-240V-1900lm-4000°K-CRI85

\* Alimentatore dimmerabile a taglio di fase / Dimmable phase cut power supply / Dimmbare Phasenanschnitt-Betriebsgerät / Alimentation dimmable à coupure de phase

DATI TECNICI / TECHNICAL DATA	
2615A-52	G9 60W-240V L 50mm
2615A-3047	LED 6W-220-240V-600lm-3000°K-CRI85
2615A-2747	LED 6W-220-240V-570lm-2700°K-CRI85
2615A-4047	LED 6W-220-240V-636lm-4000°K-CRI85

2613B

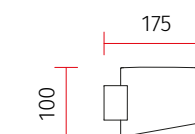
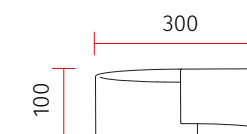

2614B

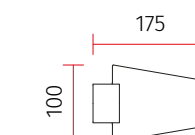
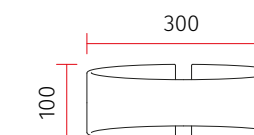

2615A

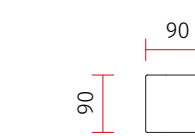
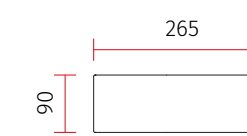

Art. 2613B

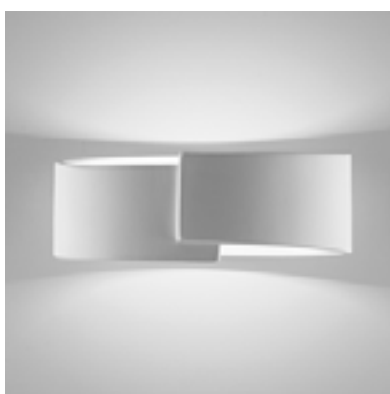

Art. 2614B



Art. 2615A



IT Misure espresse in mm, tolleranza +/- 1-2 mm. L'azienda si riserva la facoltà di apportare variazioni di dati caratteristici, materiali, design, stili, tonalità, senza alcun preavviso.  
EN Measures in mm, tolerance +/- 1/2 mm. The company reserves the right to carry out variations to technical details, materials, design, style, colors with no previous notice.

DE Die Masse sind in mm, mit einer Tolleranz von +/- 1-2 mm ausgedrückt, Die Firma behält sich das Recht vor ohne Voranmeldung Änderungen an den Werkstoffen, am Design, am Stil und an der Färbung vorzunehmen.  
FR Mesures en mm, tolérance +/- 1/2 mm. La société se réserve le droit de modifier sans préavis les détails techniques, les matériaux, le design, le style et les couleurs.

**A PARETE**  
Wall lighting  
Wandleuchten  
Appliques

CRISTALY<sup>®</sup>

made in Italy



CASAMBI Pg.408

Art. 2623C - Private house - León, Spain



DATI TECNICI / TECHNICAL DATA

2623C-3036	LED 2x6.5W-700mA-1800lm-3000°K-CRI90
2623C-2736	LED 2x6.5W-700mA-1730lm-2700°K-CRI90
2623C-4036	LED 2x6.5W-700mA-1870lm-4000°K-CRI90
026.173	DRIVER ON/OFF min7W max19.6W 700mA
026.219	DRIVER DIM PUSH /0-10V/DALI 19.6W 700mA
026.207	DRIVER DIM 0-10V 60.2W 700mA
026.206	DRIVER DIM PUSH/DALI 60.2W 700mA

ACCESSORI / ACCESSORIES

099.142	Pg.415 Kit emergenza / Emergency Kit
---------	--------------------------------------

Designer  
Itamar Harari

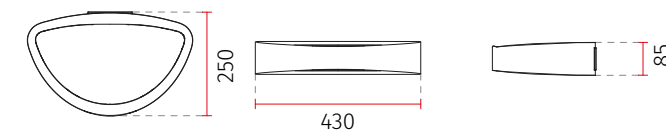
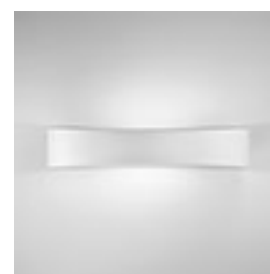

2,9 Kg

**2623D**

DATI TECNICI / TECHNICAL DATA

2623D-3036	LED 2x6.5W-700mA-1800lm-3000°K-CRI90
2623D-2736	LED 2x6.5W-700mA-1730lm-2700°K-CRI90
2623D-4036	LED 2x6.5W-700mA-1870lm-4000°K-CRI90
026.173	DRIVER ON/OFF min7W max19.6W 700mA
026.219	DRIVER DIM PUSH /0-10V/DALI 19.6W 700mA
026.207	DRIVER DIM 0-10V 60.2W 700mA
026.206	DRIVER DIM PUSH/DALI 60.2W 700mA

ACCESSORI / ACCESSORIES

099.142	Pg.415 Kit emergenza / Emergency Kit
---------	--------------------------------------

Designer  
Itamar Harari

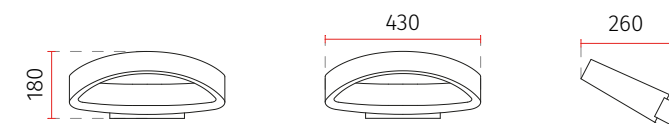

2,9 Kg

L'alimentatore dimmerabile non può essere installato nell'applicazione ma deve essere installato in una scatola di derivazione remota.

EN The dimmable driver shall not be installed in the wall lamp, but on a remote box.

DE Der dimmbare Betriebsgerät darf nicht in der Wandleuchte installiert werden, sondern im Schaltkasten

FR L'alimentation dimmable ne doit pas être installé dans l'applique, mais dans une boîte électrique

IT Misure espresse in mm, tolleranza +/- 1-2 mm. L'azienda si riserva la facoltà di apportare variazioni di dati caratteristici, materiali, design, stili, tonalità, senza alcun preavviso.  
EN Measures in mm, tolerance +/- 1/2 mm. The company reserves the right to carry out variations to technical details, materials, design, style, colors with no previous notice.

DE Die Masse sind in mm, mit einer Tolleranz von +/- 1-2 mm ausgedrückt, Die Firma behält sich das Recht vor ohne Voranmeldung Änderungen an den Werkstoffen, am Design, am Stil und an der Färbung vorzunehmen.  
FR Mesures en mm, tolérance +/- 1/2 mm. La société se réserve le droit de modifier sans préavis les détails techniques, les matériaux, le design, le style et les couleurs.

# A PARETE

## Wall lighting

## Wandleuchten

## Appliques

CERAMICA 1000

made in Italy

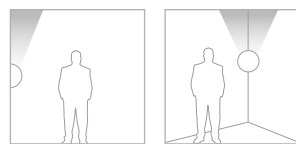

Art. 7156 - Private house - Rennes, France



### DATI TECNICI / TECHNICAL DATA

7156-41	E27 52W-240V L 145mm
7156-51	R7s 78mm 120W-240V
7156-57	R7s 118mm MAX 20W-220-240V
7156-3052	LED 12W-220-240V-1800lm-3000°K-CRI85
7156-2752	LED 12W-220-240V-1700lm-2700°K-CRI85
7156-4052	LED 12W-220-240V-1900lm-4000°K-CRI85
7156-3052T	DIM LED* 12W-220-240V-1800lm-3000°K-CRI85
7156-2752T	DIM LED* 12W-220-240V-1700lm-2700°K-CRI85
7156-4052T	DIM LED* 12W-220-240V-1900lm-4000°K-CRI85

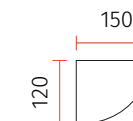
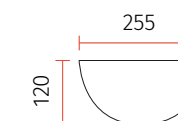

\* Alimentatore dimmerabile a taglio di fase / Dimmable phase cut power supply /  
Dimmbare Phasenanschnitt-Betriebsgerät / Alimentation dimmable à coupure de phase

# 7156



### DATI TECNICI / TECHNICAL DATA

7157-41	E27 52W-240V L 190mm
7157-51	R7s 78mm 120W-240V
7157-57	R7s 118mm MAX 20W-220-240V
7157-3052	LED 12W-220-240V-1800lm-3000°K-CRI85
7157-2752	LED 12W-220-240V-1700lm-2700°K-CRI85
7157-4052	LED 12W-220-240V-1900lm-4000°K-CRI85
7157-3052T	DIM LED* 12W-220-240V-1800lm-3000°K-CRI85
7157-2752T	DIM LED* 12W-220-240V-1700lm-2700°K-CRI85
7157-4052T	DIM LED* 12W-220-240V-1900lm-4000°K-CRI85

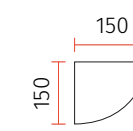
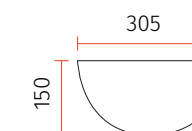

\* Alimentatore dimmerabile a taglio di fase / Dimmable phase cut power supply /  
Dimmbare Phasenanschnitt-Betriebsgerät / Alimentation dimmable à coupure de phase

# 7157



### DATI TECNICI / TECHNICAL DATA

7305-42	E27 52W-240V L 115mm
7305-3064	LED 12W-220-240V-1800lm-3000°K-CRI85
7305-2764	LED 12W-220-240V-1700lm-2700°K-CRI85
7305-4064	LED 12W-220-240V-1900lm-4000°K-CRI85
7305-3064T	DIM LED* 12W-220-240V-1800lm-3000°K-CRI85
7305-2764T	DIM LED* 12W-220-240V-1700lm-2700°K-CRI85
7305-4064T	DIM LED* 12W-220-240V-1900lm-4000°K-CRI85

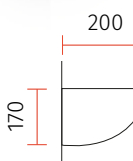
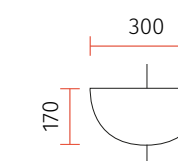

\* Alimentatore dimmerabile a taglio di fase / Dimmable phase cut power supply /  
Dimmbare Phasenanschnitt-Betriebsgerät / Alimentation dimmable à coupure de phase

# 7305



### DATI TECNICI / TECHNICAL DATA

7310-41	E27 52W-240V L 115mm
7310-51	R7s 78mm 120W-240V
7310-57	R7s 118mm MAX 20W-220-240V
7310-3051	LED 9W-220-240V-1350lm-3000°K-CRI85
7310-2751	LED 9W-220-240V-1300lm-2700°K-CRI85
7310-4051	LED 9W-220-240V-1400lm-4000°K-CRI85
7310-3051T	DIM LED* 9W-220-240V-1350lm-3000°K-CRI85
7310-2751T	DIM LED* 9W-220-240V-1300lm-2700°K-CRI85
7310-4051T	DIM LED* 9W-220-240V-1400lm-4000°K-CRI85

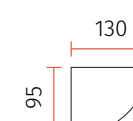
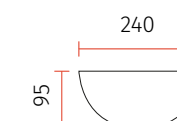

\* Alimentatore dimmerabile a taglio di fase / Dimmable phase cut power supply /  
Dimmbare Phasenanschnitt-Betriebsgerät / Alimentation dimmable à coupure de phase

# 7310



IT Misure espresse in mm, tolleranza +/- 1-2 mm. L'azienda si riserva la facoltà di apportare variazioni di dati caratteristici, materiali, design, stili, tonalità, senza alcun preavviso.  
EN Measures in mm, tolerance +/- 1/2 mm. The company reserves the right to carry out variations to technical details, materials, design, style, colors with no previous notice.

DE Die Masse sind in mm, mit einer Tolleranz von +/- 1-2 mm ausgedrückt, Die Firma behält sich das Recht vor ohne Voranmeldung Änderungen an den Werkstoffen, am Design, am Stil und an der Färbung vorzunehmen.  
FR Mesures en mm, tolérance +/- 1/2 mm. La société se réserve le droit de modifier sans préavis les détails techniques, les matériaux, le design, le style et les couleurs.

**A PARETE**  
Wall lighting  
Wandleuchten  
Appliques

CERAMICA 9000

made in Italy

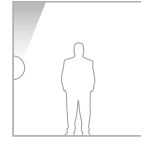

Art. 7577 - Office - Milano, Italy



**DATI TECNICI / TECHNICAL DATA**

7576-41	E27 52W-240V L 120mm
7576-51	R7s 78mm 120W-240V
7576-57	R7s 118mm MAX 20W-220-240V
7576-3052	LED 12W-220-240V-1800lm-3000°K-CRI85
7576-2752	LED 12W-220-240V-1700lm-2700°K-CRI85
7576-4052	LED 12W-220-240V-1900lm-4000°K-CRI85
7576-3052T	DIM LED* 12W-220-240V-1800lm-3000°K-CRI85
7576-2752T	DIM LED* 12W-220-240V-1700lm-2700°K-CRI85
7576-4052T	DIM LED* 12W-220-240V-1900lm-4000°K-CRI85

\* Alimentatore dimmerabile a taglio di fase / Dimmable phase cut power supply /  
Dimmbare Phasenanschnitt-Betriebsgerät / Alimentation dimmable à coupure de phase



**7576**

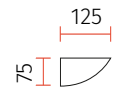
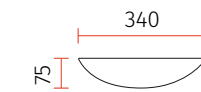

**DATI TECNICI / TECHNICAL DATA**

7577-41	E27 52W-240V L 155mm
7577-51	R7s 78mm 120W-240V
7577-57	R7s 118mm MAX 20W-220-240V
7577-3053	LED 15W-220-240V-2250lm-3000°K-CRI85
7577-2753	LED 15W-220-240V-2150lm-2700°K-CRI85
7577-4053	LED 15W-220-240V-2350lm-4000°K-CRI85
7577-3053T	DIM LED* 15W-220-240V-2250lm-3000°K-CRI85
7577-2753T	DIM LED* 15W-220-240V-2150lm-2700°K-CRI85
7577-4053T	DIM LED* 15W-220-240V-2350lm-4000°K-CRI85

\* Alimentatore dimmerabile a taglio di fase / Dimmable phase cut power supply /  
Dimmbare Phasenanschnitt-Betriebsgerät / Alimentation dimmable à coupure de phase

**7577**

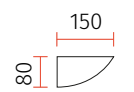
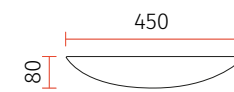

**DATI TECNICI / TECHNICAL DATA**

7578-41	E27 52W-240V L 205mm
7578-51	R7s 78mm 120W-240V
7578-57	R7s 118mm MAX 20W-220-240V
7578-3055	LED 24W-220-240V-3600lm-3000°K-CRI85
7578-2755	LED 24W-220-240V-3400lm-2700°K-CRI85
7578-4055	LED 24W-220-240V-3800lm-4000°K-CRI85
7578-3055T	DIM LED* 24W-220-240V-3600lm-3000°K-CRI85
7578-2755T	DIM LED* 24W-220-240V-3400lm-2700°K-CRI85
7578-4055T	DIM LED* 24W-220-240V-3800lm-4000°K-CRI85

\* Alimentatore dimmerabile a taglio di fase / Dimmable phase cut power supply /  
Dimmbare Phasenanschnitt-Betriebsgerät / Alimentation dimmable à coupure de phase

**7578**

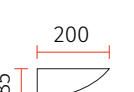

IT Misure espresse in mm, tolleranza +/- 1-2 mm. L'azienda si riserva la facoltà di apportare variazioni di dati caratteristici, materiali, design, stili, tonalità, senza alcun preavviso.  
EN Measures in mm, tolerance +/- 1/2 mm. The company reserves the right to carry out variations to technical details, materials, design, style, colors with no previous notice.

DE Die Masse sind in mm, mit einer Tolleranz von +/- 1-2 mm ausgedrückt, Die Firma behält sich das Recht vor ohne Voranmeldung Änderungen an den Werkstoffen, am Design, am Stil und an der Färbung vorzunehmen.  
FR Mesures en mm, tolérance +/- 1/2 mm. La société se réserve le droit de modifier sans préavis les détails techniques, les matériaux, le design, le style et les couleurs.

**A PARETE**  
Wall lighting  
Wandleuchten  
Appliques

CERAMICA 1000

made in Italy

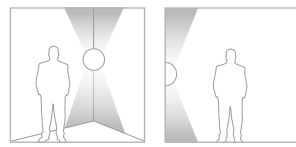

Art. 8215 - Private house - Metz, France



Art. 7946



Art. 8259



IT Misure espresse in mm, tolleranza +/- 1-2 mm. L'azienda si riserva la facoltà di apportare variazioni di dati caratteristici, materiali, design, stili, tonalità, senza alcun preavviso.  
EN Measures in mm, tolerance +/- 1/2 mm. The company reserves the right to carry out variations to technical details, materials, design, style, colors with no previous notice.

**DATI TECNICI / TECHNICAL DATA**

7946-41	E27 52W-240V L 195mm
7946-53	R7s 78mm 120W-240V
7946-57	R7s 118mm MAX 20W-220-240V
7946-3059	LED 15W-220-240V-2250lm-3000°K-CRI85
7946-2759	LED 15W-220-240V-2150lm-2700°K-CRI85
7946-4059	LED 15W-220-240V-2350lm-4000°K-CRI85
7946-3059T	DIM LED* 15W-220-240V-2250lm-3000°K-CRI85
7946-2759T	DIM LED* 15W-220-240V-2150lm-2700°K-CRI85
7946-4059T	DIM LED* 15W-220-240V-2350lm-4000°K-CRI85

\* Alimentatore dimmerabile a taglio di fase / Dimmable phase cut power supply / Dimmbare Phasenanschnitt-Betriebsgerät / Alimentation dimmable à coupure de phase

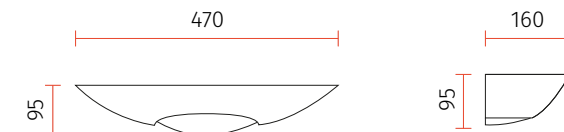

**7946**

SECTION INDEX  
GENERAL INDEX

**DATI TECNICI / TECHNICAL DATA**

7949-42	E27 52W-240V L 100mm
---------	----------------------

\* Alimentatore dimmerabile a taglio di fase / Dimmable phase cut power supply / Dimmbare Phasenanschnitt-Betriebsgerät / Alimentation dimmable à coupure de phase

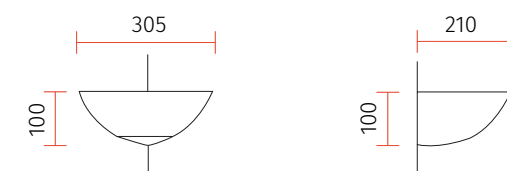

**7949**

**DATI TECNICI / TECHNICAL DATA**

8215-41	E27 52W-240V L 115mm
8215-53	R7s 78mm 120W-240V
8215-57	R7s 118mm MAX 20W-220-240V
8215-3057	LED 9W-220-240V-1350lm-3000°K-CRI85
8215-2757	LED 9W-220-240V-1300lm-2700°K-CRI85
8215-4057	LED 9W-220-240V-1400lm-4000°K-CRI85
8215-3057T	DIM LED* 9W-220-240V-1350lm-3000°K-CRI85
8215-2757T	DIM LED* 9W-220-240V-1300lm-2700°K-CRI85
8215-4057T	DIM LED* 9W-220-240V-1400lm-4000°K-CRI85

\* Alimentatore dimmerabile a taglio di fase / Dimmable phase cut power supply / Dimmbare Phasenanschnitt-Betriebsgerät / Alimentation dimmable à coupure de phase

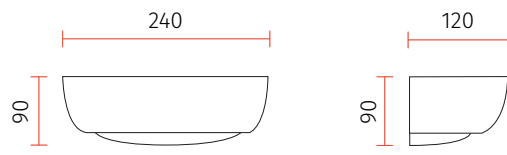

**8215**

**DATI TECNICI / TECHNICAL DATA**

8259-41	E27 52W-240V L 175mm
8259-53	R7s 78mm 120W-240V
8259-57	R7s 118mm MAX 20W-220-240V
8259-3059	LED 15W-220-240V-2250lm-3000°K-CRI85
8259-2759	LED 15W-220-240V-2150lm-2700°K-CRI85
8259-4059	LED 15W-220-240V-2350lm-4000°K-CRI85
8259-3059T	DIM LED* 15W-220-240V-2250lm-3000°K-CRI85
8259-2759T	DIM LED* 15W-220-240V-2150lm-2700°K-CRI85
8259-4059T	DIM LED* 15W-220-240V-2350lm-4000°K-CRI85

DE Die Masse sind in mm, mit einer Tolleranz von +/- 1-2 mm ausgedrückt, Die Firma behält sich das Recht vor ohne Voranmeldung Änderungen an den Werkstoffen, am Design, am Stil und an der Färbung vorzunehmen.  
FR Mesures en mm, tolérance +/- 1/2 mm. La société se réserve le droit de modifier sans préavis les détails techniques, les matériaux, le design, le style et les couleurs.

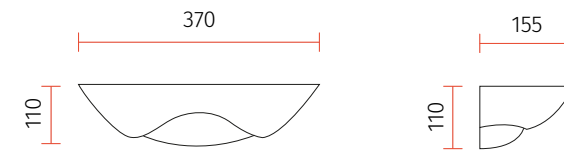

**8259**

# A PARETE

## Wall lighting

## Wandleuchten

## Appliques

CERAMICA 1010

made in Italy

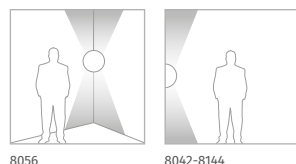

FINITURE SU RICHIESTA / FINISHES ON DEMAND  
OBERFLÄCHENVERARBEITUNGEN AUF NACHFRAGE / FINITIONS SUR DEMANDE:

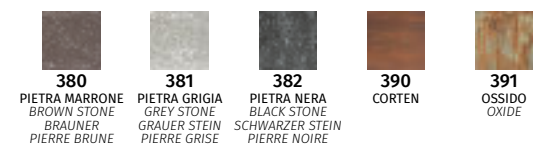

Art. 8042 - Office - Trieste, Italy



Diffusore in vetro  
Glass diffuser  
Glasabdeckung  
Diffuseur en verre

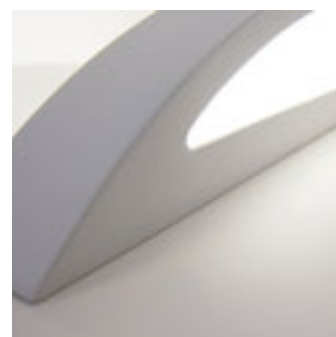

IT Misure espresse in mm, tolleranza +/- 1-2 mm. L'azienda si riserva la facoltà di apportare variazioni di dati caratteristici, materiali, design, stili, tonalità, senza alcun preavviso.  
EN Measures in mm, tolerance +/- 1/2 mm. The company reserves the right to carry out variations to technical details, materials, design, style, colors with no previous notice.

### DATI TECNICI / TECHNICAL DATA

8042-41	E27 52W-240V L 150mm Ø45	
8042-53	R7s 78mm 120W-240V	
8042-57	R7s 118mm MAX 20W-220-240V	
8042-3071	LED 15W-220-240V-2250lm-3000°K-CRI85	
8042-2771	LED 15W-220-240V-2150lm-2700°K-CRI85	
8042-4071	LED 15W-220-240V-2350lm-4000°K-CRI85	
8042-3071T	DIM LED* 15W-220-240V-2250lm-3000°K-CRI85	
8042-2771T	DIM LED* 15W-220-240V-2150lm-2700°K-CRI85	
8042-4071T	DIM LED* 15W-220-240V-2350lm-4000°K-CRI85	

\* Alimentatore dimmerabile a taglio di fase / Dimmable phase cut power supply /  
Dimmbare Phasenanschnitt-Betriebsgerät / Alimentation dimmable à coupure de phase



# 8056

### DATI TECNICI / TECHNICAL DATA

8056-42	E27 52W-240V L 120mm Ø45	
8056-3070	LED 12W-220-240V-1800lm-3000°K-CRI85	
8056-2770	LED 12W-220-240V-1700lm-2700°K-CRI85	
8056-4070	LED 12W-220-240V-1900lm-4000°K-CRI85	
8056-3070T	DIM LED* 12W-220-240V-1800lm-3000°K-CRI85	
8056-2770T	DIM LED* 12W-220-240V-1700lm-2700°K-CRI85	
8056-4070T	DIM LED* 12W-220-240V-1900lm-4000°K-CRI85	

\* Alimentatore dimmerabile a taglio di fase / Dimmable phase cut power supply /  
Dimmbare Phasenanschnitt-Betriebsgerät / Alimentation dimmable à coupure de phase

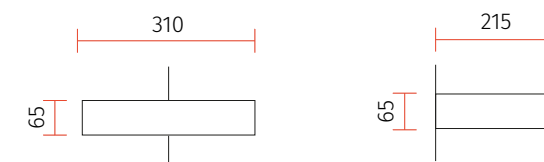

# 8144

### DATI TECNICI / TECHNICAL DATA

8144-41	E27 52W-240V L 160mm Ø45	
8144-53	R7s 78mm 120W-240V	
8144-57	R7s 118mm MAX 20W-220-240V	
8144-3071	LED 15W-220-240V-2250lm-3000°K-CRI85	
8144-2771	LED 15W-220-240V-2150lm-2700°K-CRI85	
8144-4071	LED 15W-220-240V-2350lm-4000°K-CRI85	
8144-3071T	DIM LED* 15W-220-240V-2250lm-3000°K-CRI85	
8144-2771T	DIM LED* 15W-220-240V-2150lm-2700°K-CRI85	
8144-4071T	DIM LED* 15W-220-240V-2350lm-4000°K-CRI85	

\* Alimentatore dimmerabile a taglio di fase / Dimmable phase cut power supply /  
Dimmbare Phasenanschnitt-Betriebsgerät / Alimentation dimmable à coupure de phase



DE Die Masse sind in mm, mit einer Tolleranz von +/- 1-2 mm ausgedrückt, Die Firma behält sich das Recht vor ohne Voranmeldung Änderungen an den Werkstoffen, am Design, am Stil und an der Färbung vorzunehmen.  
FR Mesures en mm, tolérance +/- 1/2 mm. La société se réserve le droit de modifier sans préavis les détails techniques, les matériaux, le design, le style et les couleurs.

# A PARETE

Wall lighting  
Wandleuchten  
Appliques

CERAMICA 9000

made in Italy



Art. 8254 - Private house - Gorizia, Italy



Diffusore in vetro  
Glass diffuser  
Glasabdeckung  
Diffuseur en verre



## DATI TECNICI / TECHNICAL DATA

8216-41	E27 52W-240V L 110mm
8216-53	R7s 78mm 120W-240V
8216-57	R7s 118mm MAX 20W-220-240V
8216-3057	LED 9W-220-240V-1350lm-3000°K-CRI85
8216-2757	LED 9W-220-240V-1300lm-2700°K-CRI85
8216-4057	LED 9W-220-240V-1400lm-4000°K-CRI85
8216-3057T	DIM LED* 9W-220-240V-1350lm-3000°K-CRI85
8216-2757T	DIM LED* 9W-220-240V-1300lm-2700°K-CRI85
8216-4057T	DIM LED* 9W-220-240V-1400lm-4000°K-CRI85

\* Alimentatore dimmerabile a taglio di fase / Dimmable phase cut power supply /  
Dimmbare Phasenanschnitt-Betriebsgerät / Alimentation dimmable à coupure de phase

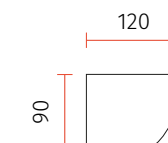
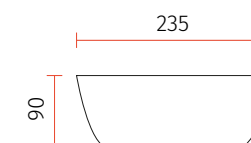

## 8254

## DATI TECNICI / TECHNICAL DATA

8254-41	E27 52W-240V L 195mm
8254-53	R7s 78mm 120W-240V
8254-57	R7s 118mm MAX 20W-220-240V
8254-3059	LED 15W-220-240V-2250lm-3000°K-CRI85
8254-2759	LED 15W-220-240V-2150lm-2700°K-CRI85
8254-4059	LED 15W-220-240V-2350lm-4000°K-CRI85
8254-3059T	DIM LED* 15W-220-240V-2250lm-3000°K-CRI85
8254-2759T	DIM LED* 15W-220-240V-2150lm-2700°K-CRI85
8254-4059T	DIM LED* 15W-220-240V-2350lm-4000°K-CRI85

\* Alimentatore dimmerabile a taglio di fase / Dimmable phase cut power supply /  
Dimmbare Phasenanschnitt-Betriebsgerät / Alimentation dimmable à coupure de phase

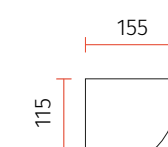
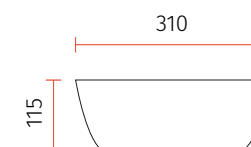

IT Misure espresse in mm, tolleranza +/- 1-2 mm. L'azienda si riserva la facoltà di apportare variazioni di dati caratteristici, materiali, design, stili, tonalità, senza alcun preavviso.  
EN Measures in mm, tolerance +/- 1/2 mm. The company reserves the right to carry out variations to technical details, materials, design, style, colors with no previous notice.

DE Die Masse sind in mm, mit einer Tolleranz von +/- 1-2 mm ausgedrückt, Die Firma behält sich das Recht vor ohne Voranmeldung Änderungen an den Werkstoffen, am Design, am Stil und an der Färbung vorzunehmen.  
FR Mesures en mm, tolérance +/- 1/2 mm. La société se réserve le droit de modifier sans préavis les détails techniques, les matériaux, le design, le style et les couleurs.

**A PARETE**  
Wall lighting  
Wandleuchten  
Appliques

CERAMICA 9000

made in Italy

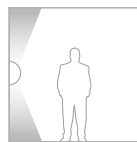

Art. 8411



**DATI TECNICI / TECHNICAL DATA**

8235-41	E27 52W-240V L 115mm
8235-53	R7s 78mm 120W-240V
8235-57	R7s 118mm MAX 20W-220-240V
8235-3076	LED 13.5W-220-240V-2000lm-3000°K-CRI85
8235-2776	LED 13.5W-220-240V-1900lm-2700°K-CRI85
8235-4076	LED 13.5W-220-240V-2100lm-4000°K-CRI85
8235-3076T	DIM LED* 13.5W-220-240V-2000lm-3000°K-CRI85
8235-2776T	DIM LED* 13.5W-220-240V-1900lm-2700°K-CRI85
8235-4076T	DIM LED* 13.5W-220-240V-2100lm-4000°K-CRI85

\* Alimentatore dimmerabile a taglio di fase / Dimmable phase cut power supply /  
Dimmbare Phasenanschnitt-Betriebsgerät / Alimentation dimmable à coupure de phase



**8235**

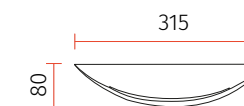
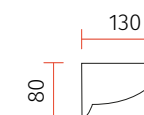

**DATI TECNICI / TECHNICAL DATA**

8411-41	E27 52W-240V L 195mm
8411-53	R7s 78mm 120W-240V
8411-57	R7s 118mm MAX 20W-220-240V
8411-3078	LED 19.5W-220-240V-2900lm-3000°K-CRI85
8411-2778	LED 19.5W-220-240V-2750lm-2700°K-CRI85
8411-4078	LED 19.5W-220-240V-3050lm-4000°K-CRI85
8411-3078T	DIM LED* 19.5W-220-240V-2900lm-3000°K-CRI85
8411-2778T	DIM LED* 19.5W-220-240V-2750lm-2700°K-CRI85
8411-4078T	DIM LED* 19.5W-220-240V-3050lm-4000°K-CRI85

\* Alimentatore dimmerabile a taglio di fase / Dimmable phase cut power supply /  
Dimmbare Phasenanschnitt-Betriebsgerät / Alimentation dimmable à coupure de phase

**8411**

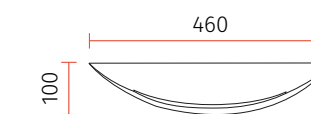
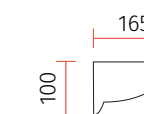



# A PARETE

Wall lighting  
Wandleuchten  
Appliques

CERAMICA 9000

made in Italy

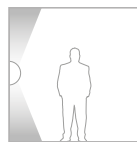

## DATI TECNICI / TECHNICAL DATA

8284-51	R7s 78mm 120W-240V
8284-52	G9 2X60W-240V L 90mm
8284-57	R7s 118mm MAX 20W-220-240V
8284-3071	LED 15W-220-240V-2250lm-3000°K-CRI85
8284-2771	LED 15W-220-240V-2150lm-2700°K-CRI85
8284-4071	LED 15W-220-240V-2350lm-4000°K-CRI85



# 8284

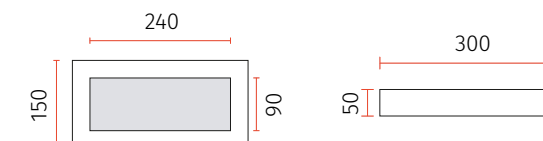

Art. 8284 - Private house - Leipzig, Germany



Diffusore in vetro  
Glass diffuser  
Glasabdeckung  
Diffuseur en verre

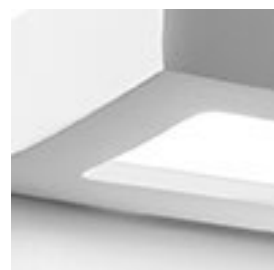

## DATI TECNICI / TECHNICAL DATA

8382-52	G9 2X60W-240V L 90mm
8382-53	R7s 78mm 120W-240V
8382-57	R7s 118mm MAX 20W-220-240V
8382-3071	LED 15W-220-240V-2250lm-3000°K-CRI85
8382-2771	LED 15W-220-240V-2150lm-2700°K-CRI85
8382-4071	LED 15W-220-240V-2350lm-4000°K-CRI85

# 8382

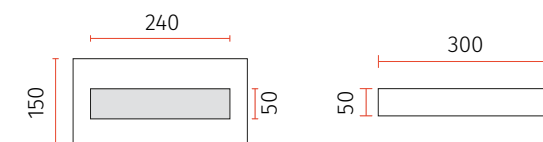

IT Misure espresse in mm, tolleranza +/- 1-2 mm. L'azienda si riserva la facoltà di apportare variazioni di dati caratteristici, materiali, design, stili, tonalità, senza alcun preavviso.  
EN Measures in mm, tolerance +/- 1/2 mm. The company reserves the right to carry out variations to technical details, materials, design, style, colors with no previous notice.

DE Die Masse sind in mm, mit einer Tolleranz von +/- 1-2 mm ausgedrückt, Die Firma behält sich das Recht vor ohne Voranmeldung Änderungen an den Werkstoffen, am Design, am Stil und an der Färbung vorzunehmen.  
FR Mesures en mm, tolérance +/- 1/2 mm. La société se réserve le droit de modifier sans préavis les détails techniques, les matériaux, le design, le style et les couleurs.

# A PARETE

## Wall lighting

## Wandleuchten

## Appliques

CERAMICA 9000

made in Italy

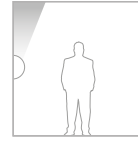

Art. 8337 - Office - Roma, Italy



### DATI TECNICI / TECHNICAL DATA

8336-51	R7s 78mm 120W-240V
8336-52	G9 2X60W-240V L 70mm
8336-57	R7s 118mm MAX 20W-220-240V
8336-3065	LED 15W-220-240V-2250lm-3000°K-CRI85
8336-2765	LED 15W-220-240V-2150lm-2700°K-CRI85
8336-4065	LED 15W-220-240V-2350lm-4000°K-CRI85
8336-3065T	DIM LED* 15W-220-240V-2250lm-3000°K-CRI85
8336-2765T	DIM LED* 15W-220-240V-2150lm-2700°K-CRI85
8336-4065T	DIM LED* 15W-220-240V-2350lm-4000°K-CRI85

\* Alimentatore dimmerabile a taglio di fase / Dimmable phase cut power supply / Dimmbare Phasenanschnitt-Betriebsgerät / Alimentation dimmable à coupure de phase

8336

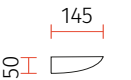
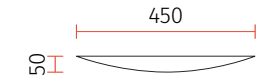

### DATI TECNICI / TECHNICAL DATA

8337-51	R7s 78mm 120W-240V
8337-52	G9 2X60W-240V L 70mm
8337-57	R7s 118mm MAX 20W-220-240V
8337-3066	LED 18W-220-240V-2700lm-3000°K-CRI85
8337-2766	LED 18W-220-240V-2550lm-2700°K-CRI85
8337-4066	LED 18W-220-240V-2850lm-4000°K-CRI85
8337-3066T	DIM LED* 18W-220-240V-2700lm-3000°K-CRI85
8337-2766T	DIM LED* 18W-220-240V-2550lm-2700°K-CRI85
8337-4066T	DIM LED* 18W-220-240V-2850lm-4000°K-CRI85

\* Alimentatore dimmerabile a taglio di fase / Dimmable phase cut power supply / Dimmbare Phasenanschnitt-Betriebsgerät / Alimentation dimmable à coupure de phase

8337

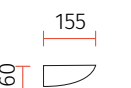
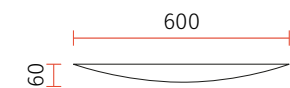

### DATI TECNICI / TECHNICAL DATA

8338-51	R7s 78mm 2X120W-240V
8338-52	G9 2X60W-240V L 70mm
8338-57	R7s 118mm 2XMAX 20W-220-240V
8338-3067	LED 24W-220-240V-3600lm-3000°K-CRI85
8338-2767	LED 24W-220-240V-3400lm-2700°K-CRI85
8338-4067	LED 24W-220-240V-3800lm-4000°K-CRI85
8338-3067T	DIM LED* 24W-220-240V-3600lm-3000°K-CRI85
8338-2767T	DIM LED* 24W-220-240V-3400lm-2700°K-CRI85
8338-4067T	DIM LED* 24W-220-240V-3800lm-4000°K-CRI85

\* Alimentatore dimmerabile a taglio di fase / Dimmable phase cut power supply / Dimmbare Phasenanschnitt-Betriebsgerät / Alimentation dimmable à coupure de phase

8338

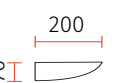
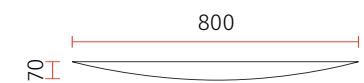

IT Misure espresse in mm, tolleranza +/- 1-2 mm. L'azienda si riserva la facoltà di apportare variazioni di dati caratteristici, materiali, design, stili, tonalità, senza alcun preavviso.  
EN Measures in mm, tolerance +/- 1/2 mm. The company reserves the right to carry out variations to technical details, materials, design, style, colors with no previous notice.

DE Die Masse sind in mm, mit einer Tolleranz von +/- 1-2 mm ausgedrückt, Die Firma behält sich das Recht vor ohne Voranmeldung Änderungen an den Werkstoffen, am Design, am Stil und an der Färbung vorzunehmen.  
FR Mesures en mm, tolérance +/- 1/2 mm. La société se réserve le droit de modifier sans préavis les détails techniques, les matériaux, le design, le style et les couleurs.

# A PARETE

## Wall lighting

## Wandleuchten

## Appliques

CERAMICA 1000

made in Italy



Art. 8428 - Office - Palencia, Spain



Art. 9207



9207:  
Diffusore in vetro  
Glass diffuser  
Glasabdeckung  
Diffuseur en verre

### DATI TECNICI / TECHNICAL DATA

8428-41	E27 52W-240V L 145mm
8428-51	R7s 78mm 120W-240V
8428-57	R7s 118mm MAX 20W-220-240V
8428-3053	LED 15W-220-240V-2250lm-3000°K-CRI85
8428-2753	LED 15W-220-240V-2150lm-2700°K-CRI85
8428-4053	LED 15W-220-240V-2350lm-4000°K-CRI85
8428-3053T	DIM LED* 15W-220-240V-2250lm-3000°K-CRI85
8428-2753T	DIM LED* 15W-220-240V-2150lm-2700°K-CRI85
8428-4053T	DIM LED* 15W-220-240V-2350lm-4000°K-CRI85

\* Alimentatore dimmerabile a taglio di fase / Dimmable phase cut power supply /  
Dimmbare Phasenanschnitt-Betriebsgerät / Alimentation dimmable à coupure de phase

# 8428



1,25 Kg

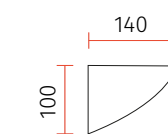

### DATI TECNICI / TECHNICAL DATA

9207-41	E27 52W-240V L 115mm
9207-53	R7s 78mm 120W-240V
9207-57	R7s 118mm MAX 20W-220-240V
9207-3057	LED 9W-220-240V-1350lm-3000°K-CRI85
9207-2757	LED 9W-220-240V-1300lm-2700°K-CRI85
9207-4057	LED 9W-220-240V-1400lm-4000°K-CRI85
9207-3057	DIM LED* 9W-220-240V-1350lm-3000°K-CRI85
9207-2757	DIM LED* 9W-220-240V-1300lm-2700°K-CRI85
9207-4057	DIM LED* 9W-220-240V-1400lm-4000°K-CRI85

\* Alimentatore dimmerabile a taglio di fase / Dimmable phase cut power supply /  
Dimmbare Phasenanschnitt-Betriebsgerät / Alimentation dimmable à coupure de phase

# 9207



0,85 Kg

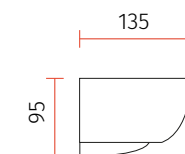
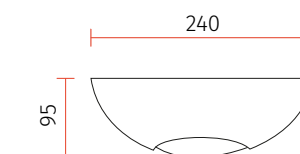

# A PARETE

## Wall lighting

## Wandleuchten

## Appliques

CERAMICA 900

made in Italy



8429 - 8430 - 8431  
 FINITURE SU RICHIESTA / FINISHES ON DEMAND  
 OBERFLÄCHENVERARBEITUNGEN AUF NACHFRAGE / FINITIONS SUR DEMANDE:



Art. 8430 - Private house - Tours, France



Art. 8430

Art. 8285



IT Misure espresse in mm, tolleranza +/- 1-2 mm. L'azienda si riserva la facoltà di apportare variazioni di dati caratteristici, materiali, design, stili, tonalità, senza alcun preavviso.  
 EN Measures in mm, tolerance +/- 1/2 mm. The company reserves the right to carry out variations to technical details, materials, design, style, colors with no previous notice.

### DATI TECNICI / TECHNICAL DATA

8429-51	R7s 78mm 120W-240V
8429-57	R7s 118mm MAX 20W-220-240V
8429-3052	LED 12W-220-240V-1800lm-3000°K-CRI85
8429-2752	LED 12W-220-240V-1700lm-2700°K-CRI85
8429-4052	LED 12W-220-240V-1900lm-4000°K-CRI85
8429-3052T	DIM LED* 12W-220-240V-1800lm-3000°K-CRI85
8429-2752T	DIM LED* 12W-220-240V-1700lm-2700°K-CRI85
8429-4052T	DIM LED* 12W-220-240V-1900lm-4000°K-CRI85

\* Alimentatore dimmerabile a taglio di fase / Dimmable phase cut power supply /  
 Dimmbare Phasenanschnitt-Betriebsgerät / Alimentation dimmable à coupure de phase

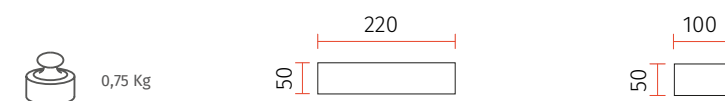

8429



### DATI TECNICI / TECHNICAL DATA

8430-51	R7s 78mm 120W-240V
8430-57	R7s 118mm MAX 20W-220-240V
8430-3054	LED 18W-220-240V-2700lm-3000°K-CRI85
8430-2754	LED 18W-220-240V-2550lm-2700°K-CRI85
8430-4054	LED 18W-220-240V-2850lm-4000°K-CRI85
8430-3054T	DIM LED* 18W-220-240V-2700lm-3000°K-CRI85
8430-2754T	DIM LED* 18W-220-240V-2550lm-2700°K-CRI85
8430-4054T	DIM LED* 18W-220-240V-2850lm-4000°K-CRI85

\* Alimentatore dimmerabile a taglio di fase / Dimmable phase cut power supply /  
 Dimmbare Phasenanschnitt-Betriebsgerät / Alimentation dimmable à coupure de phase

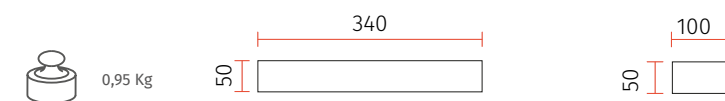

8430



### DATI TECNICI / TECHNICAL DATA

8431-51	R7s 78mm 2X120W-240V
8431-57	R7s 118mm 2XMAX 20W-220-240V
8431-3055	LED 24W-220-240V-3600lm-3000°K-CRI85
8431-2755	LED 24W-220-240V-3400lm-2700°K-CRI85
8431-4055	LED 24W-220-240V-3800lm-4000°K-CRI85
8431-3055T	DIM LED* 24W-220-240V-3600lm-3000°K-CRI85
8431-2755T	DIM LED* 24W-220-240V-3400lm-2700°K-CRI85
8431-4055T	DIM LED* 24W-220-240V-3800lm-4000°K-CRI85

\* Alimentatore dimmerabile a taglio di fase / Dimmable phase cut power supply /  
 Dimmbare Phasenanschnitt-Betriebsgerät / Alimentation dimmable à coupure de phase

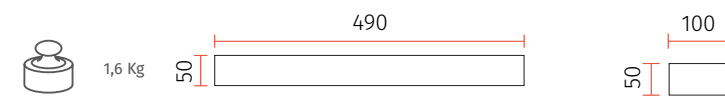

8431



### DATI TECNICI / TECHNICAL DATA

8285-52	G9 2X60W-240V L 85mm
8285-3065	LED 15W-220-240V-2250lm-3000°K-CRI85
8285-2765	LED 15W-220-240V-2150lm-2700°K-CRI85
8285-4065	LED 15W-220-240V-2350lm-4000°K-CRI85
8285-3065T	DIM LED* 15W-220-240V-2250lm-3000°K-CRI85
8285-2765T	DIM LED* 15W-220-240V-2150lm-2700°K-CRI85
8285-4065T	DIM LED* 15W-220-240V-2350lm-4000°K-CRI85
8431-4055T	DIM LED* 24W-220-240V-3800lm-4000°K-CRI85

\* Alimentatore dimmerabile a taglio di fase / Dimmable phase cut power supply /  
 Dimmbare Phasenanschnitt-Betriebsgerät / Alimentation dimmable à coupure de phase

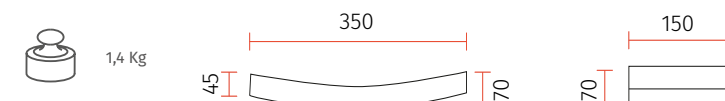

8285



DE Die Masse sind in mm, mit einer Tolleranz von +/- 1-2 mm ausgedrückt, Die Firma behält sich das Recht vor ohne Voranmeldung Änderungen an den Werkstoffen, am Design, am Stil und an der Färbung vorzunehmen.  
 FR Mesures en mm, tolérance +/- 1/2 mm. La société se réserve le droit de modifier sans préavis les détails techniques, les matériaux, le design, le style et les couleurs.

**A PARETE**  
Wall lighting  
Wandleuchten  
Appliques

CERAMICA 9000

made in Italy

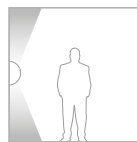

DATI TECNICI / TECHNICAL DATA	
8459-52	G9 60W-240V L 100mm
8459-3069	LED 9W-220-240V-1350lm-3000°K-CRI85
8459-2769	LED 9W-220-240V-1300lm-2700°K-CRI85
8459-4069	LED 9W-220-240V-1400lm-4000°K-CRI85



**8459**

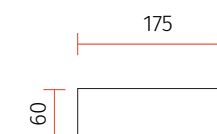
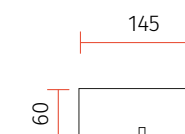

Art. 8481 - Private house - Vantaa, Finland



Art. 8459

Art. 8481

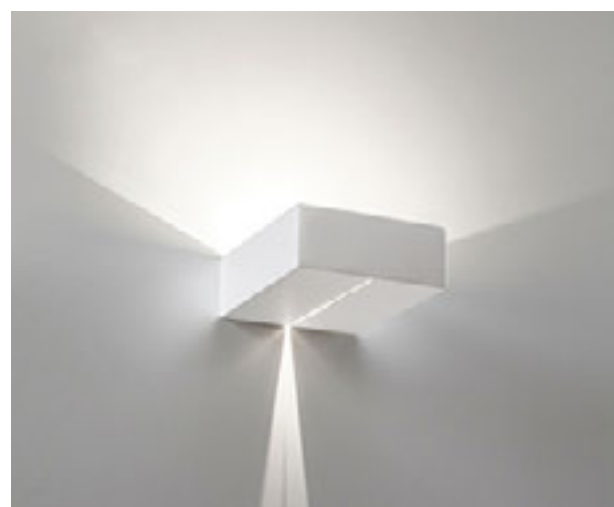

DATI TECNICI / TECHNICAL DATA	
8481-53	R7s 78mm 120W-240V
8481-57	R7s 118mm MAX 20W-220-240V
8481-3078	LED 19.5W-220-240V-2900lm-3000°K-CRI85
8481-2778	LED 19.5W-220-240V-2750lm-2700°K-CRI85
8481-4078	LED 19.5W-220-240V-3050lm-4000°K-CRI85
8481-3078T	DIM LED* 19.5W-220-240V-2900lm-3000°K-CRI85
8481-2778T	DIM LED* 19.5W-220-240V-2750lm-2700°K-CRI85
8481-4078T	DIM LED* 19.5W-220-240V-3050lm-4000°K-CRI85

\* Alimentatore dimmerabile a taglio di fase / Dimmable phase cut power supply / Dimmbare Phasenanschnitt-Betriebsgerät / Alimentation dimmable à coupure de phase

**8481**

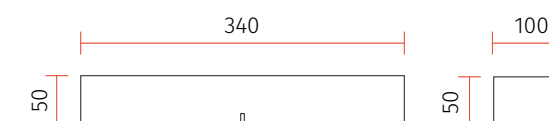

IT Misure espresse in mm, tolleranza +/- 1-2 mm. L'azienda si riserva la facoltà di apportare variazioni di dati caratteristici, materiali, design, stili, tonalità, senza alcun preavviso.  
EN Measures in mm, tolerance +/- 1/2 mm. The company reserves the right to carry out variations to technical details, materials, design, style, colors with no previous notice.

DE Die Masse sind in mm, mit einer Tolleranz von +/- 1-2 mm ausgedrückt, Die Firma behält sich das Recht vor ohne Voranmeldung Änderungen an den Werkstoffen, am Design, am Stil und an der Färbung vorzunehmen.  
FR Mesures en mm, tolérance +/- 1/2 mm. La société se réserve le droit de modifier sans préavis les détails techniques, les matériaux, le design, le style et les couleurs.

# A PARETE

## Wall lighting

## Wandleuchten

## Appliques

CERAMICA 9000

made in Italy



FINITURE SU RICHIESTA / FINISHES ON DEMAND  
 OBERFLÄCHENVERARBEITUNGEN AUF NACHFRAGE / FINITIONS SUR DEMANDE:

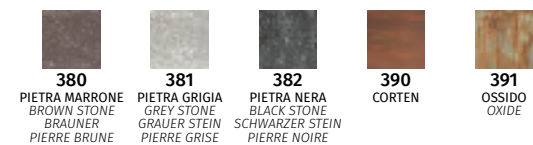

Art. 8672B - Office - Graz, Austria



IT Misure espresse in mm, tolleranza +/- 1-2 mm. L'azienda si riserva la facoltà di apportare variazioni di dati caratteristici, materiali, design, stili, tonalità, senza alcun preavviso.  
 EN Measures in mm, tolerance +/- 1/2 mm. The company reserves the right to carry out variations to technical details, materials, design, style, colors with no previous notice.

### DATI TECNICI / TECHNICAL DATA

8672-51 R7s 78mm 80W-240V

8672

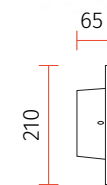
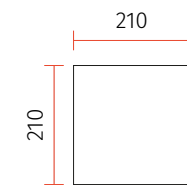

### DATI TECNICI / TECHNICAL DATA

8672B-3080	LED 18W-220-240V-2700lm-3000°K-CRI85
8672B-2780	LED 18W-220-240V-2550lm-2700°K-CRI85
8672B-4080	LED 18W-220-240V-2850lm-4000°K-CRI85
8672B-3080T	DIM LED* 18W-220-240V-2700lm-3000°K-CRI85
8672B-2780T	DIM LED* 18W-220-240V-2550lm-2700°K-CRI85
8672B-4080T	DIM LED* 18W-220-240V-2850lm-4000°K-CRI85

\* Alimentatore dimmerabile a taglio di fase / Dimmable phase cut power supply /  
 Dimmbare Phasenanschnitt-Betriebsgerät / Alimentation dimmable à coupure de phase

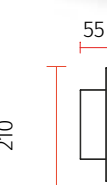
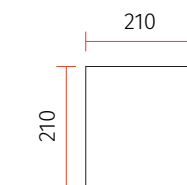

8672B

### DATI TECNICI / TECHNICAL DATA

8673-51 R7s 78mm 80W-240V

8673

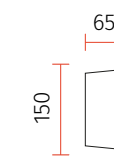
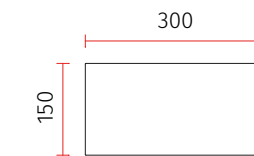

### DATI TECNICI / TECHNICAL DATA

8673B-3081	LED 24W-220-240V-3600lm-3000°K-CRI85
8673B-2781	LED 24W-220-240V-3400lm-2700°K-CRI85
8673B-4081	LED 24W-220-240V-3800lm-4000°K-CRI85
8673B-3081T	DIM LED* 24W-220-240V-3600lm-3000°K-CRI85
8673B-2781T	DIM LED* 24W-220-240V-3400lm-2700°K-CRI85
8673B-4081T	DIM LED* 24W-220-240V-3800lm-4000°K-CRI85

\* Alimentatore dimmerabile a taglio di fase / Dimmable phase cut power supply /  
 Dimmbare Phasenanschnitt-Betriebsgerät / Alimentation dimmable à coupure de phase

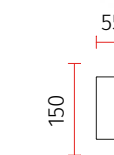
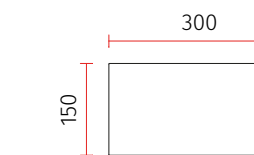

8673B

DE Die Masse sind in mm, mit einer Tolleranz von +/- 1-2 mm ausgedrückt, Die Firma behält sich das Recht vor ohne Voranmeldung Änderungen an den Werkstoffen, am Design, am Stil und an der Färbung vorzunehmen.  
 FR Mesures en mm, tolérance +/- 1/2 mm. La société se réserve le droit de modifier sans préavis les détails techniques, les matériaux, le design, le style et les couleurs.

**A PARETE**  
Wall lighting  
Wandleuchten  
Appliques

CERAMICA 9000

made in Italy



Art. 8760



**DATI TECNICI / TECHNICAL DATA**

8759-41	E27 52W-240V L 215mm Ø45	
8759-53	R7s 78mm 120W-240V	
8759-57	R7s 118mm MAX 20W-220-240V	
8759-3072	LED 18W-220-240V-2700lm-3000°K-CRI85	
8759-2772	LED 18W-220-240V-2550lm-2700°K-CRI85	
8759-4072	LED 18W-220-240V-2850lm-4000°K-CRI85	
8759-3072T	DIM LED* 18W-220-240V-2700lm-3000°K-CRI85	
8759-2772T	DIM LED* 18W-220-240V-2550lm-2700°K-CRI85	
8759-4072T	DIM LED* 18W-220-240V-2850lm-4000°K-CRI85	

\* Alimentatore dimmerabile a taglio di fase / Dimmable phase cut power supply /  
Dimmbare Phasenanschnitt-Betriebsgerät / Alimentation dimmable à coupure de phase

**8759**

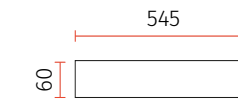
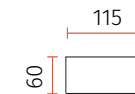

**DATI TECNICI / TECHNICAL DATA**

8760-41	E27 2X52W-240V L 145mm Ø45	
8760-53	R7s 78mm 2X120W-240V	
8760-57	R7s 118mm 2XMAX 20W-220-240V	
8760-3061	LED 24W-220-240V-3600lm-3000°K-CRI85	
8760-2761	LED 24W-220-240V-3400lm-2700°K-CRI85	
8760-4061	LED 24W-220-240V-3800lm-4000°K-CRI85	
8760-3061T	DIM LED* 24W-220-240V-3600lm-3000°K-CRI85	
8760-2761T	DIM LED* 24W-220-240V-3400lm-2700°K-CRI85	
8760-4061T	DIM LED* 24W-220-240V-3800lm-4000°K-CRI85	



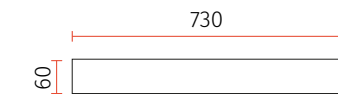
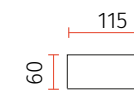

\* Alimentatore dimmerabile a taglio di fase / Dimmable phase cut power supply /  
Dimmbare Phasenanschnitt-Betriebsgerät / Alimentation dimmable à coupure de phase

**8760**

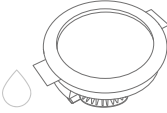
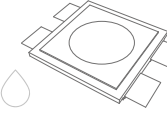
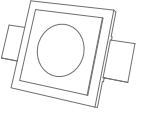
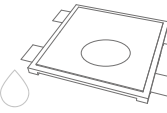
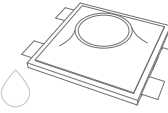
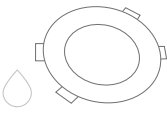
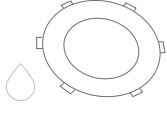
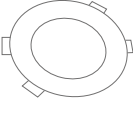
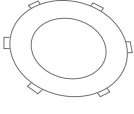
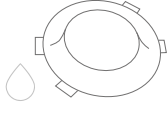
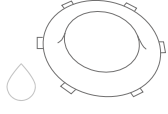
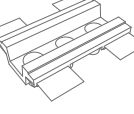
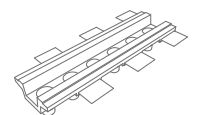
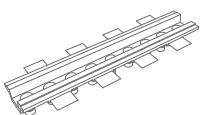
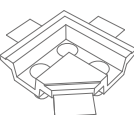
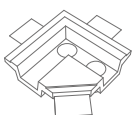
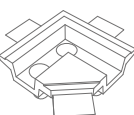
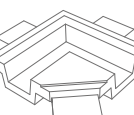
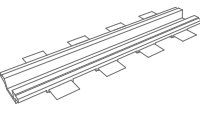
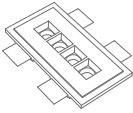
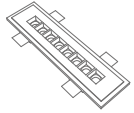
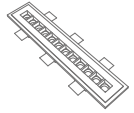
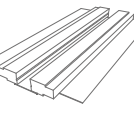
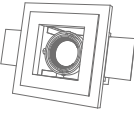
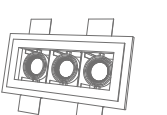
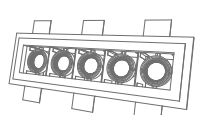
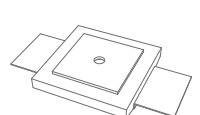
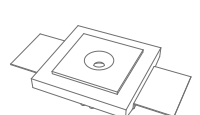
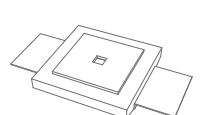
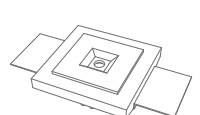
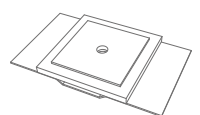
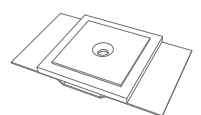
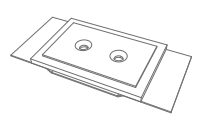
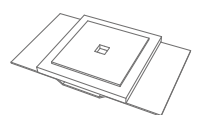
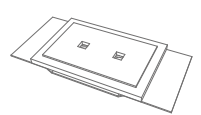
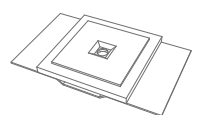
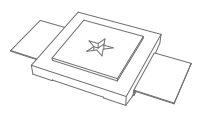
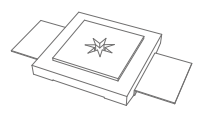
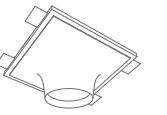
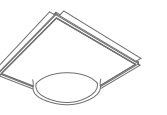
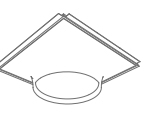
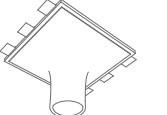
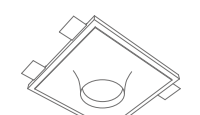
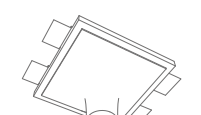

# INCASSO A PLAFONE

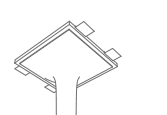
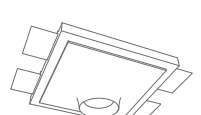
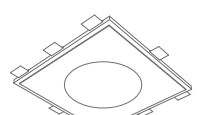
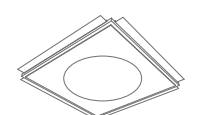
Ceiling recessed lighting  
Decken-Einbauleuchten  
Encastrés Plafonds

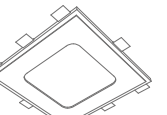
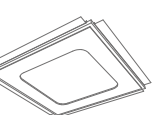
					
4042 p.160	4044B p.161	4177 p.161	4110 p.165	4111 p.165	4113 p.167
					
4118 p.167	4113B p.169	4118B p.169	4114 p.173	4122 p.173	4191C p.175
					
4191F p.175	4191I p.175	4191K p.176	4191X p.176	4191Y p.177	4192K p.177
					
4192I p.177	4196D p.179	4196H p.179	4196N p.179	<b>NEW</b> 4197 p.181	<b>NEW</b> 4246A p.185
					
<b>NEW</b> 4246C p.185	<b>NEW</b> 4246E p.185	<b>NEW</b> 4247A p.188	<b>NEW</b> 4248A p.188	<b>NEW</b> 4249A p.189	<b>NEW</b> 4250A p.189
					
<b>NEW</b> 4247E p.193	<b>NEW</b> 4248E p.194	<b>NEW</b> 4248F p.195	<b>NEW</b> 4249E p.196	<b>NEW</b> 4249F p.197	<b>NEW</b> 4250E p.201
					
<b>NEW</b> 4251A p.204	<b>NEW</b> 4252A p.205	8935A p.207	8935B p.207	8935C p.207	8935D p.209
					
8935M p.209	8935G p.210	8935H p.211	8935I p.211	8935L p.211	8936A p.213
					
8936B p.213	8917 p.214	8937A p.215	8937B p.215		

 IP20 / IP44



# INCASSO A PLAFONE

## Ceiling recessed lighting

### Decken-Einbauleuchten

### Encastrés Plafonds

CRISTALY®

made in Italy

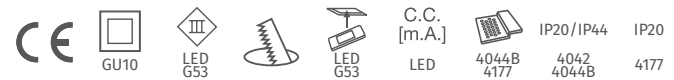
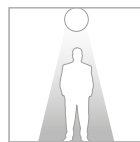

CASAMBI Pg.408

Art. 4044B - Shopping Center - Berlin, Germany



#### DATI TECNICI / TECHNICAL DATA

4044B-35	GU10 Ø111 MAX 20W-240V
4044B-92	G53 (QR111) MAX 20W-12V
4044B-3006	LED 6.5W-350mA-850lm-3000°K-CRI90
4044B-2706	LED 6.5W-350mA-800lm-2700°K-CRI90
4044B-4006	LED 6.5W-350mA-900lm-4000°K-CRI90
026.251	DRIVER ON/OFF min6W max8.8W 350mA
026.252	DRIVER ON/OFF min12.6W max18.2W 350mA
026.221	DRIVER ON/OFF min9.8W max35W 350mA
026.219	DRIVER DIM PUSH/0-10V/DALI 16.1W 350mA
026.187	DRIVER DIM 0-10V 35W 350mA
026.185	DRIVER DIM PUSH/DALI 35W 350mA
4044B-3008	LED 13W-700mA-1600lm-3000°K-CRI90
4044B-2708	LED 13W-700mA-1500lm-2700°K-CRI90
4044B-4008	LED 13W-700mA-1700lm-4000°K-CRI90
026.255	DRIVER ON/OFF min11.9W max18.2W 700mA
026.256	DRIVER ON/OFF min24.9W max35.7W 700mA
026.219	DRIVER DIM PUSH/0-10V/DALI 19.6W 700mA
026.207	DRIVER DIM 0-10V 60.2W 700mA
026.206	DRIVER DIM PUSH/DALI 60.2W 700mA

#### ACCESSORI / ACCESSORIES

023.447	Controcassa per muratura / Housing box for brickwork / Einbaugeschäule für Betonwand / Boîtier pour béton/briques [200x200x120mm]
099.142	Pg.415 Kit emergenza / Emergency Kit

SECTION INDEX GENERAL INDEX

# 4044B



1,8 Kg

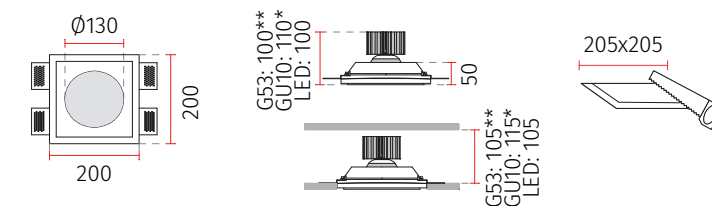

\* =altezza inclusa lampadina OSRAM H75 mm e portalamпада / height including OSRAM H75 mm lamp and lampholder / Höhe inkl. OSRAM H75 mm Lampe und Fassung / Hauteur compris ampoule OSRAM H75 mm et source

\*\* =altezza inclusa lampadina OSRAM H55 mm e portalamпада / height including OSRAM H55 mm lamp and lampholder / Höhe inkl. OSRAM H55 mm Lampe und Fassung / Hauteur compris ampoule OSRAM H55 mm et source

#### DATI TECNICI / TECHNICAL DATA

4177-35	GU10 Ø50 MAX 35W-240V
---------	-----------------------

#### ACCESSORI / ACCESSORIES

023.416	Controcassa per muratura / Housing box for brickwork / Einbaugeschäule für Betonwand / Boîtier pour béton/briques [155x155x130mm]
L001-3018	LED 8W-220-240V-650lm-3000°K-CRI85-60°
L002-3020	LED 12W-220-240V-1000lm-3000°K-CRI85-60°
L004-3018	LED 8W-220-240V-650lm-3000°K-CRI85-30°
L005-3020	LED 12W-220-240V-1000lm-3000°K-CRI85-30°
021.231	Portalamпада / Lampholder / Lampenfassung / Source GU5.3

# 4177



0,9 Kg

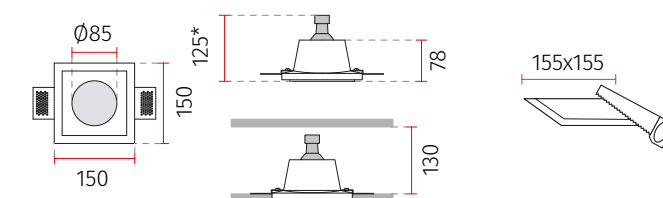

\* =altezza inclusa lampadina OSRAM GU10 H52 mm e portalamпада / height including OSRAM GU10 H52 mm lamp and lampholder / Höhe inkl. OSRAM GU10 H52 mm Lampe und Fassung / Hauteur compris ampoule OSRAM GU10 H52 mm et source

# 4042



2,4 Kg

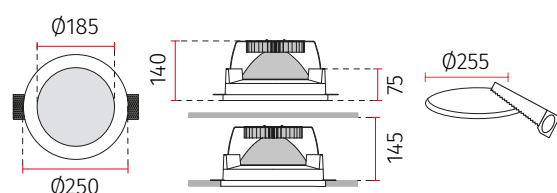

#### DATI TECNICI / TECHNICAL DATA

4042-3009	LED 26W-700mA-3300lm-3000°K-CRI85
4042-2709	LED 26W-700mA-3150lm-2700°K-CRI85
4042-4009	LED 26W-700mA-3400lm-4000°K-CRI85
026.256	DRIVER ON/OFF min24.9W max35.7W 700mA
026.207	DRIVER DIM 0-10V 60.2W 700mA
026.206	DRIVER DIM PUSH/DALI 60.2W 700mA

#### ACCESSORI / ACCESSORIES

099.142	Pg.415 Kit emergenza / Emergency Kit
---------	--------------------------------------

IT Misure espresse in mm, tolleranza +/- 1-2 mm. L'azienda si riserva la facoltà di apportare variazioni di dati caratteristici, materiali, design, stili, tonalità, senza alcun preavviso.  
EN Measures in mm, tolerance +/- 1/2 mm. The company reserves the right to carry out variations to technical details, materials, design, style, colors with no previous notice.

DE Die Masse sind in mm, mit einer Tolleranz von +/- 1-2 mm ausgedrückt, Die Firma behält sich das Recht vor ohne Voranmeldung Änderungen an den Werkstoffen, am Design, am Stil und an der Färbung vorzunehmen.  
FR Mesures en mm, tolérance +/- 1/2 mm. La société se réserve le droit de modifier sans préavis les détails techniques, les matériaux, le design, le style et les couleurs.

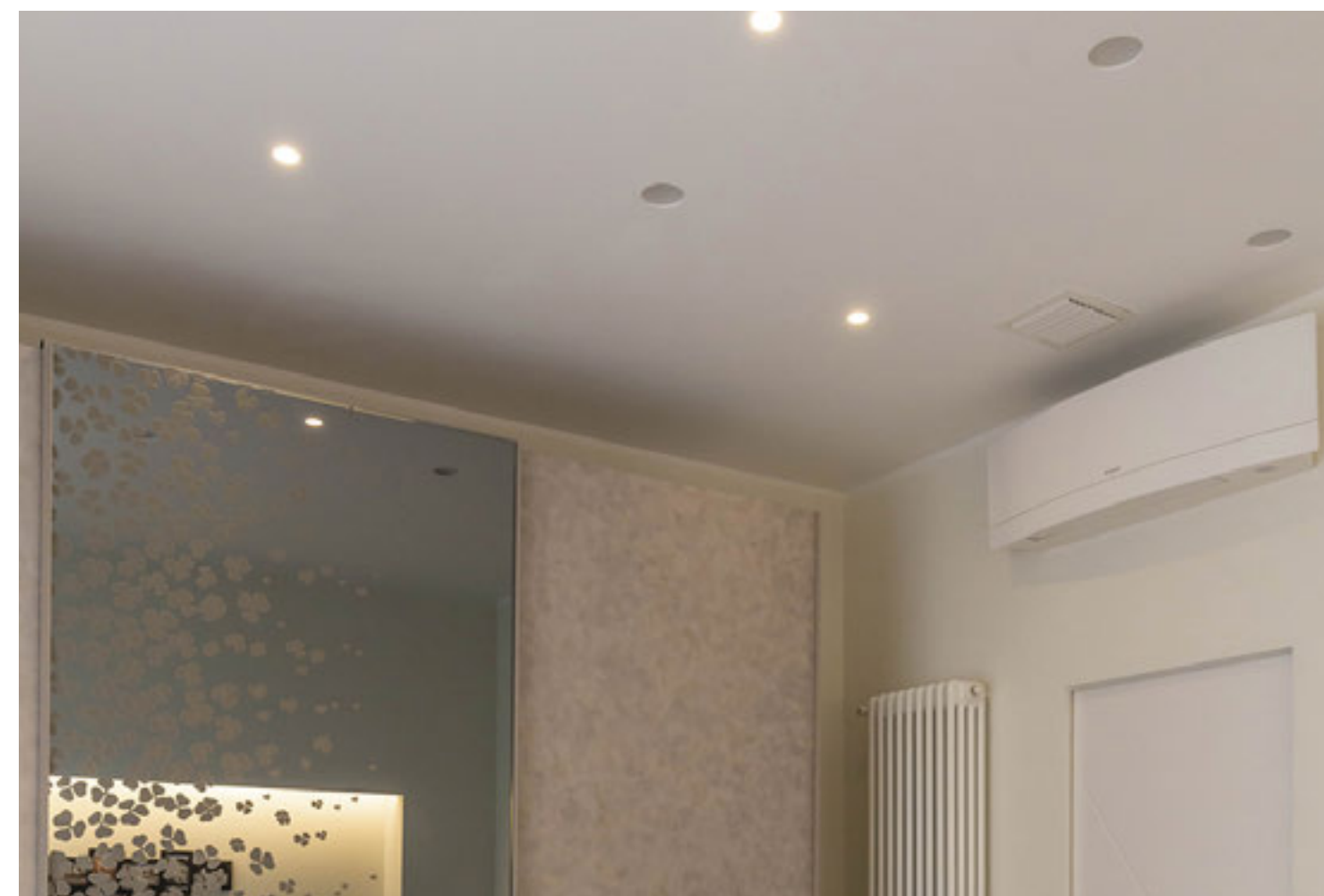

# INCASSO A PLAFONE

## Ceiling recessed lighting

### Decken-Einbauleuchten

### Encastrés Plafonds

CRISTALY®

made in Italy

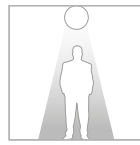

CASAMBI Pg.408

Art. 4110 / 8935A - Thermalressort Köck, Bad Füssing – Germany  
Architekturbüro arCH-de.com, Roththalmünster



Diffusore in vetro  
Glass diffuser  
 Glasabdeckung  
 Diffuseur en verre



#### DATI TECNICI / TECHNICAL DATA

4110-3006	LED 6.5W-350mA-850lm-3000°K-CRI90
4110-2706	LED 6.5W-350mA-800lm-2700°K-CRI90
4110-4006	LED 6.5W-350mA-900lm-4000°K-CRI90
026.251	DRIVER ON/OFF min6W max8.8W 350mA
026.252	DRIVER ON/OFF min12.6W max18.2W 350mA
026.221	DRIVER ON/OFF min9.8W max35W 350mA
026.219	DRIVER DIM PUSH/0-10V/DALI 16.1W 350mA
026.187	DRIVER DIM 0-10V 35W 350mA
026.185	DRIVER DIM PUSH/DALI 35W 350mA
4110-3008	LED 13W-700mA-1600lm-3000°K-CRI90
4110-2708	LED 13W-700mA-1500lm-2700°K-CRI90
4110-4008	LED 13W-700mA-1700lm-4000°K-CRI90
026.255	DRIVER ON/OFF min11.9W max18.2W 700mA
026.256	DRIVER ON/OFF min24.9W max35.7W 700mA
026.219	DRIVER DIM PUSH/0-10V/DALI 19.6W 700mA
026.207	DRIVER DIM 0-10V 60.2W 700mA
026.206	DRIVER DIM PUSH/DALI 60.2W 700mA

#### ACCESSORI / ACCESSORIES

099.142	Pg.415 Kit emergenza / Emergency Kit
---------	--------------------------------------

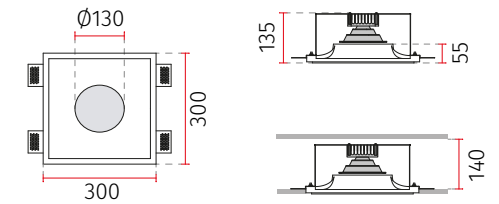

4110

2,5 Kg

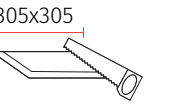

#### DATI TECNICI / TECHNICAL DATA

4111-3006	LED 6.5W-350mA-850lm-3000°K-CRI90
4111-2706	LED 6.5W-350mA-800lm-2700°K-CRI90
4111-4006	LED 6.5W-350mA-900lm-4000°K-CRI90
026.251	DRIVER ON/OFF min6W max8.8W 350mA
026.252	DRIVER ON/OFF min12.6W max18.2W 350mA
026.221	DRIVER ON/OFF min9.8W max35W 350mA
026.219	DRIVER DIM PUSH/0-10V/DALI 16.1W 350mA
026.187	DRIVER DIM 0-10V 35W 350mA
026.185	DRIVER DIM PUSH/DALI 35W 350mA
4111-3008	LED 13W-700mA-1600lm-3000°K-CRI90
4111-2708	LED 13W-700mA-1500lm-2700°K-CRI90
4111-4008	LED 13W-700mA-1700lm-4000°K-CRI90
026.255	DRIVER ON/OFF min11.9W max18.2W 700mA
026.256	DRIVER ON/OFF min24.9W max35.7W 700mA
026.219	DRIVER DIM PUSH/0-10V/DALI 19.6W 700mA
026.207	DRIVER DIM 0-10V 60.2W 700mA
026.206	DRIVER DIM PUSH/DALI 60.2W 700mA

#### ACCESSORI / ACCESSORIES

099.142	Pg.415 Kit emergenza / Emergency Kit
---------	--------------------------------------

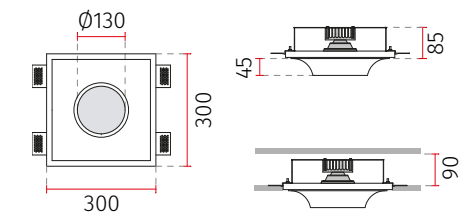

4111

2,5 Kg

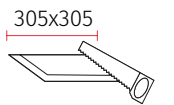

IT Misure espresse in mm, tolleranza +/- 1-2 mm. L'azienda si riserva la facoltà di apportare variazioni di dati caratteristici, materiali, design, stili, tonalità, senza alcun preavviso.  
EN Measures in mm, tolerance +/- 1/2 mm. The company reserves the right to carry out variations to technical details, materials, design, style, colors with no previous notice.

DE Die Masse sind in mm, mit einer Tolleranz von +/- 1-2 mm ausgedrückt, Die Firma behält sich das Recht vor ohne Voranmeldung Änderungen an den Werkstoffen, am Design, am Stil und an der Färbung vorzunehmen.  
FR Mesures en mm, tolérance +/- 1/2 mm. La société se réserve le droit de modifier sans préavis les détails techniques, les matériaux, le design, le style et les couleurs.

# INCASSO A PLAFONE

## Ceiling recessed lighting

### Decken-Einbauleuchten

### Encastrés Plafonds

CRISTALY®

made in Italy

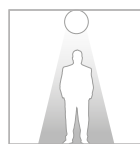

TUNABLE WHITE Pg.412

CASAMBI Pg.408

Art. 4118 - Private house - Genova, Italy



Diffusore in vetro  
Glass diffuser  
Glasabdeckung  
Diffuseur en verre



#### DATI TECNICI / TECHNICAL DATA

4113-3013	LED 30W-700mA-3500lm-3000°K-CRI85
4113-2713	LED 30W-700mA-3300lm-2700°K-CRI85
4113-4013	LED 30W-700mA-3700lm-4000°K-CRI85
026.256	DRIVER ON/OFF min24.9W max35.7W 700mA
026.207	DRIVER DIM 0-10V 60.2W 700mA
026.206	DRIVER DIM PUSH/DALI 60.2W 700mA

#### ACCESSORI / ACCESSORIES

099.142	Pg.415 Kit emergenza / Emergency Kit
---------	--------------------------------------

SECTION INDEX  
GENERAL INDEX

4113



4,9 Kg

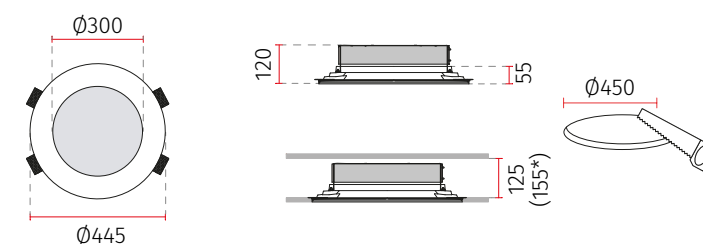

\*= Misura con alimentatore in controsoffitto / Measure with driver in counterceiling / Abmessung mit Betriebsgerät in der Zwischendecke / Mesure avec alimentation en contre-plafond

#### DATI TECNICI / TECHNICAL DATA

4118-3015	LED 88W-2x1050mA-10400lm-3000°K-CRI85
4118-2715	LED 88W-2x1050mA-9880lm-2700°K-CRI85
4118-4015	LED 88W-2x1050mA-11000lm-4000°K-CRI85
2x026.205	DRIVER ON/OFF min35.7W max59.9W 1050mA
2x026.207	DRIVER DIM 0-10V 59.9W 1050mA
2x026.206	DRIVER DIM PUSH/DALI 59.9W 1050mA

#### ACCESSORI / ACCESSORIES

099.142	Pg.415 Kit emergenza / Emergency Kit
---------	--------------------------------------

4118



13 Kg

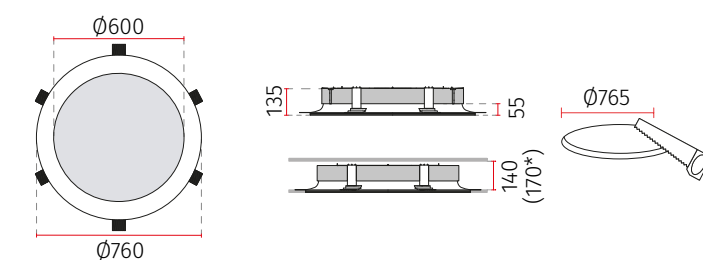

\*= Misura con alimentatore in controsoffitto / Measure with driver in counterceiling / Abmessung mit Betriebsgerät in der Zwischendecke / Mesure avec alimentation en contre-plafond

IT Misure espresse in mm, tolleranza +/- 1-2 mm. L'azienda si riserva la facoltà di apportare variazioni di dati caratteristici, materiali, design, stili, tonalità, senza alcun preavviso.  
EN Measures in mm, tollerance +/- 1/2 mm. The company reserves the right to carry out variations to technical details, materials, design, style, colors with no previous notice.

DE Die Masse sind in mm, mit einer Tolleranz von +/- 1-2 mm ausgedrückt, Die Firma behält sich das Recht vor ohne Voranmeldung Änderungen an den Werkstoffen, am Design, am Stil und an der Färbung vorzunehmen.  
FR Mesures en mm, tolérance +/- 1/2 mm. La société se réserve le droit de modifier sans préavis les détails techniques, les matériaux, le design, le style et les couleurs.

# INCASSO A PLAFONE

Ceiling recessed lighting  
Decken-Einbauleuchten  
Encastrés Plafonds

CRISTALY®

made in Italy

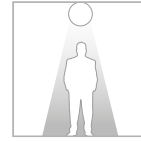

CASAMBI Pg.408

Art. 4113B - Office - Caserta, Italy



Luce indiretta  
Indirect light  
Indirekte Beleuchtung  
Lumière indirecte

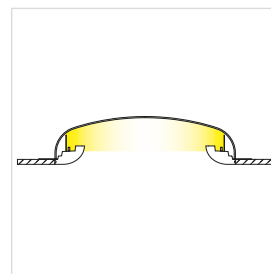

## DATI TECNICI / TECHNICAL DATA

4113B-3003	LED 37W-24Vdc-4200lm-3000°K-CRI90
4113B-2703	LED 37W-24Vdc-4000lm-2700°K-CRI90
4113B-4003	LED 37W-24Vdc-4400lm-4000°K-CRI90
026.260	DRIVER ON/OFF 60W 24V
026.261	DRIVER ON/OFF 150W 24V
026.262	DRIVER ON/OFF 240W 24V
026.209	DRIVER DIM PUSH/1-10V 60W 24V
026.190+026.261	DRIVER DIM PUSH/0-10V/DALI 150W 24V
026.190+026.262	DRIVER DIM PUSH/0-10V/DALI 240W 24V

## ACCESSORI / ACCESSORIES

099.142	Pg.415 Kit emergenza / Emergency Kit
---------	--------------------------------------

4113B



4,9 Kg

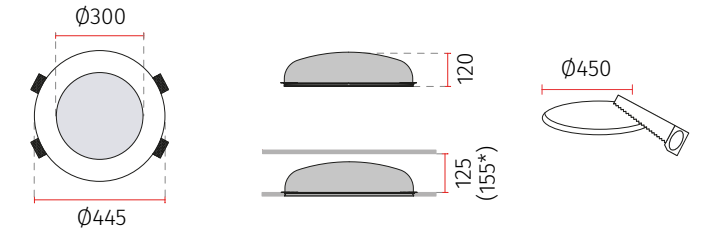

\*= Misura con alimentatore in controsoffitto / Measure with driver in counterceiling / Abmessung mit Betriebsgerät in der Zwischendecke / Mesure avec alimentation en contre-plafond

## DATI TECNICI / TECHNICAL DATA

4118B-3003	LED 55W-24Vdc-6600lm-3000°K-CRI90
4118B-2703	LED 55W-24Vdc-6300lm-2700°K-CRI90
4118B-4003	LED 55W-24Vdc-6900lm-4000°K-CRI90
026.260	DRIVER ON/OFF 60W 24V
026.261	DRIVER ON/OFF 150W 24V
026.262	DRIVER ON/OFF 240W 24V
026.209	DRIVER DIM PUSH/1-10V 60W 24V
026.190+026.261	DRIVER DIM PUSH/0-10V/DALI 150W 24V
026.190+026.262	DRIVER DIM PUSH/0-10V/DALI 240W 24V

## ACCESSORI / ACCESSORIES

099.142	Pg.415 Kit emergenza / Emergency Kit
---------	--------------------------------------

4118B



13 Kg

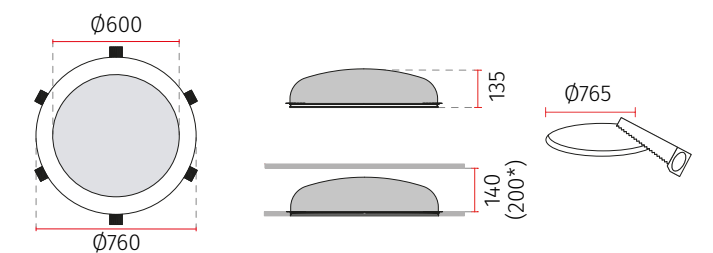

\*= Misura con alimentatore in controsoffitto / Measure with driver in counterceiling / Abmessung mit Betriebsgerät in der Zwischendecke / Mesure avec alimentation en contre-plafond

IT Misure espresse in mm, tolleranza +/- 1-2 mm. L'azienda si riserva la facoltà di apportare variazioni di dati caratteristici, materiali, design, stili, tonalità, senza alcun preavviso.  
EN Measures in mm, tolerance +/- 1/2 mm. The company reserves the right to carry out variations to technical details, materials, design, style, colors with no previous notice.

DE Die Masse sind in mm, mit einer Tolleranz von +/- 1-2 mm ausgedrückt, Die Firma behält sich das Recht vor ohne Voranmeldung Änderungen an den Werkstoffen, am Design, am Stil und an der Färbung vorzunehmen.  
FR Mesures en mm, tolérance +/- 1/2 mm. La société se réserve le droit de modifier sans préavis les détails techniques, les matériaux, le design, le style et les couleurs.



# INCASSO A PLAFONE

## Ceiling recessed lighting

### Decken-Einbauleuchten

### Encastrés Plafonds

CRISTALY®

made in Italy

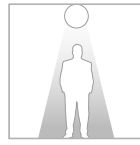

TUNABLE WHITE Pg.412 | CASAMBI Pg.408

Art. 4114 - Private house - Palermo, Italy



Diffusore in vetro  
Glass diffuser  
Glasabdeckung  
Diffuseur en verre



DATI TECNICI / TECHNICAL DATA	
4114-3013	LED 30W-700mA-3500lm-3000°K-CRI85
4114-2713	LED 30W-700mA-3300lm-2700°K-CRI85
4114-4013	LED 30W-700mA-3700lm-4000°K-CRI85
026.256	DRIVER ON/OFF min24.9W max35.7W 700mA
026.207	DRIVER DIM 0-10V 60.2W 700mA
026.206	DRIVER DIM PUSH/DALI 60.2W 700mA
ACCESSORI / ACCESSORIES	
099.142	Pg.415 Kit emergenza / Emergency Kit

SECTION INDEX  
GENERAL INDEX

4114



5,8 Kg

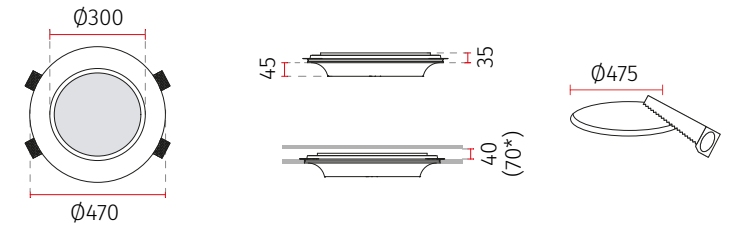

\*= Misura con alimentatore in controsoffitto / Measure with driver in counterceiling / Abmessung mit Betriebsgerät in der Zwischendecke / Mesure avec alimentation en contre-plafond

DATI TECNICI / TECHNICAL DATA	
4122-3015	LED 88W-2x1050mA-10400lm-3000°K-CRI85
4122-2715	LED 88W-2x1050mA-9880lm-2700°K-CRI85
4122-4015	LED 88W-2x1050mA-11000lm-4000°K-CRI85
2x026.205	DRIVER ON/OFF min35.7W max59.9W 1050mA
2x026.207	DRIVER DIM 0-10V 59.9W 1050mA
2x026.206	DRIVER DIM PUSH/DALI 59.9W 1050mA
ACCESSORI / ACCESSORIES	
099.142	Pg.415 Kit emergenza / Emergency Kit

4122



13 Kg

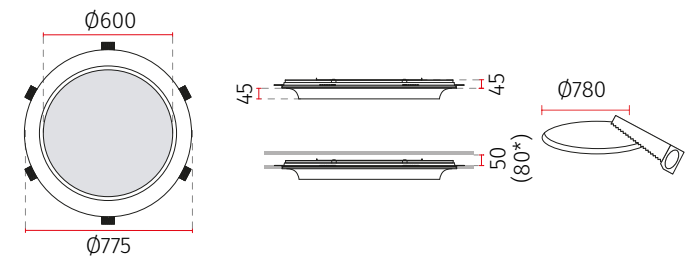

\*= Misura con alimentatore in controsoffitto / Measure with driver in counterceiling / Abmessung mit Betriebsgerät in der Zwischendecke / Mesure avec alimentation en contre-plafond

IT Misure espresse in mm, tolleranza +/- 1-2 mm. L'azienda si riserva la facoltà di apportare variazioni di dati caratteristici, materiali, design, stili, tonalità, senza alcun preavviso.  
EN Measures in mm, tolerance +/- 1/2 mm. The company reserves the right to carry out variations to technical details, materials, design, style, colors with no previous notice.

DE Die Masse sind in mm, mit einer Tolleranz von +/- 1-2 mm ausgedrückt, Die Firma behält sich das Recht vor ohne Voranmeldung Änderungen an den Werkstoffen, am Design, am Stil und an der Färbung vorzunehmen.  
FR Mesures en mm, tolérance +/- 1/2 mm. La société se réserve le droit de modifier sans préavis les détails techniques, les matériaux, le design, le style et les couleurs.

# INCASSO A PLAFONE

Ceiling recessed lighting  
Decken-Einbauleuchten  
Encastrés Plafonds

CRISTALY®

made in Italy

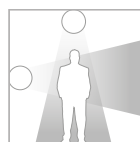

Art. 4191C / 4192I



## DATI TECNICI / TECHNICAL DATA

4191C-35 GU10 Ø35 MAX 3x5W-240V

Versione con lampadina inclusa / Version with bulb included  
Version mit Lampe enthalten / Version avec ampoule incluse:

4191C-35-L GU10 Ø35 MAX 3x5W-240V + 3xL007

## ACCESSORI / ACCESSORIES

L007 LED GU10 Ø35mm LED 3.2W-220-240V

4191T-00 Testate Di Chiusura / End caps / Endkappen / Tête de fermeture

4191C



1 Kg

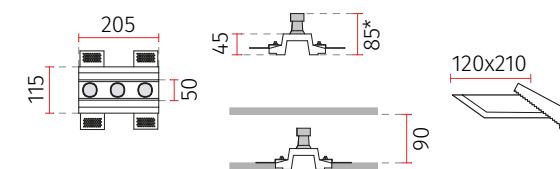

\* =altezza inclusa lampadina GU10 Ø35 mm H45 mm e portalampada  
/ height including GU10 Ø35 mm H45 mm lamp and lampholder  
/ Höhe inkl. GU10 Ø35 mm H45 mm Lampe und Fassung / Hauteur  
compris ampoule GU10 Ø35 mm H45 mm et source

## DATI TECNICI / TECHNICAL DATA

4191F-35 GU10 Ø35 MAX 6x5W-240V

Versione con lampadina inclusa / Version with bulb included  
Version mit Lampe enthalten / Version avec ampoule incluse:

4191F-35-L GU10 Ø35 MAX 6x5W-240V + 6xL007

## ACCESSORI / ACCESSORIES

L007 LED GU10 Ø35mm LED 3.2W-220-240V

4191T-00 Testate Di Chiusura / End caps / Endkappen / Tête de fermeture

4191F



1,9 Kg

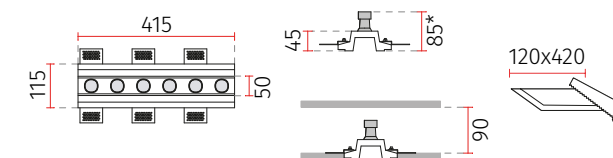

\* =altezza inclusa lampadina GU10 Ø35 mm H45 mm e portalampada  
/ height including GU10 Ø35 mm H45 mm lamp and lampholder  
/ Höhe inkl. GU10 Ø35 mm H45 mm Lampe und Fassung / Hauteur  
compris ampoule GU10 Ø35 mm H45 mm et source

## DATI TECNICI / TECHNICAL DATA

4191I-35 GU10 Ø35 MAX 9x5W-240V

Versione con lampadina inclusa / Version with bulb included  
Version mit Lampe enthalten / Version avec ampoule incluse:

4191I-35-L GU10 Ø35 MAX 9x5W-240V + 9xL007

## ACCESSORI / ACCESSORIES

L007 LED GU10 Ø35mm LED 3.2W-220-240V

4191T-00 Testate Di Chiusura / End caps / Endkappen / Tête de fermeture

4191I



2,9 Kg

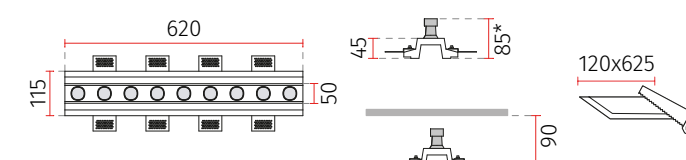

\* =altezza inclusa lampadina GU10 Ø35 mm H45 mm e portalampada  
/ height including GU10 Ø35 mm H45 mm lamp and lampholder  
/ Höhe inkl. GU10 Ø35 mm H45 mm Lampe und Fassung / Hauteur  
compris ampoule GU10 Ø35 mm H45 mm et source

IT Misure espresse in mm, tolleranza +/- 1-2 mm. L'azienda si riserva la facoltà di apportare variazioni di dati caratteristici, materiali, design, stili, tonalità, senza alcun preavviso.  
EN Measures in mm, tolerance +/- 1/2 mm. The company reserves the right to carry out variations to technical details, materials, design, style, colors with no previous notice.

DE Die Masse sind in mm, mit einer Tolleranz von +/- 1-2 mm ausgedrückt, Die Firma behält sich das Recht vor ohne Voranmeldung Änderungen an den Werkstoffen, am Design, am Stil und an der Färbung vorzunehmen.  
FR Mesures en mm, tolérance +/- 1/2 mm. La société se réserve le droit de modifier sans préavis les détails techniques, les matériaux, le design, le style et les couleurs.



# INCASSO A PLAFONE

## Ceiling recessed lighting

### Decken-Einbauleuchten

### Encastrés Plafonds

CRISTALY®

made in Italy

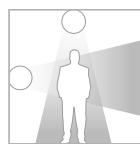

# 4191Y

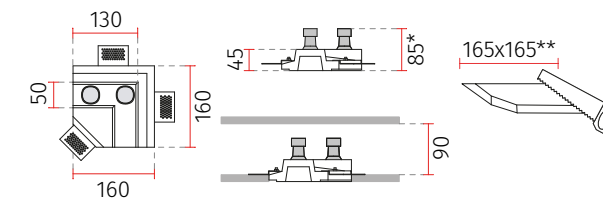

#### DATI TECNICI / TECHNICAL DATA

**4191Y-35** GU10 Ø35 MAX 2x5W-240V

Versione con lampadina inclusa / Version with bulb included  
Version mit Lampe enthalten / Version avec ampoule incluse:

**4191Y-35-L** GU10 Ø35 MAX 2x5W-240V + 2xL007

#### ACCESSORI / ACCESSORIES

**L007** LED GU10 Ø35mm LED 3.2W-220-240V

**4191T-00** Testate Di Chiusura / End caps / Endkappen / Tête de fermeture

\*= Altezza inclusa lampadina GU10 Ø35mm H45mm e portalampada / Height including GU10 Ø35mm H45mm lamp and lampholder / Höhe inkl. GU10 Ø35 mm H45 mm Lampe und Fassung / Hauteur compris ampoule GU10 Ø35 mm H45 mm et source

\*\*= Effettuare il foro ad "L" / Carry out an "L" shape cut / Führen Sie einen "L" -Formschnitt durch / Effectuer une coupe à "L"

#### DATI TECNICI / TECHNICAL DATA

**4192K-00** Senza parte elettrica / Without electrical part / Ohne elektrischen Teil / Sans partie électrique

#### ACCESSORI / ACCESSORIES

**4191T-00** Testate Di Chiusura / End caps / Endkappen / Tête de fermeture

# 4192K

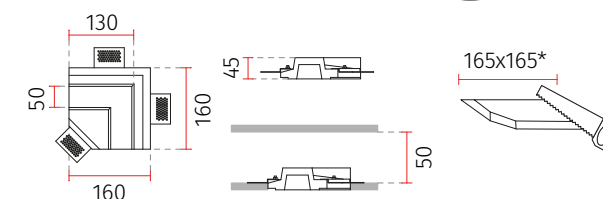

\*\*= Effettuare il foro ad "L" / Carry out an "L" shape cut / Führen Sie einen "L" -Formschnitt durch / Effectuer une coupe à "L"

#### DATI TECNICI / TECHNICAL DATA

**4192I-00** Senza parte elettrica / Without electrical part / Ohne elektrischen Teil / Sans partie électrique

#### ACCESSORI / ACCESSORIES

**4191T-00** Testate Di Chiusura / End caps / Endkappen / Tête de fermeture

# 4192I

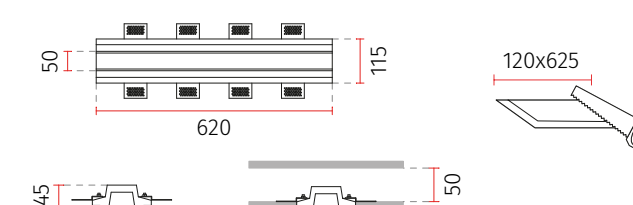

#### DATI TECNICI / TECHNICAL DATA

**4191K-35** GU10 Ø35 MAX 3x5W-240V

Versione con lampadina inclusa / Version with bulb included  
Version mit Lampe enthalten / Version avec ampoule incluse:

**4191K-35-L** GU10 Ø35 MAX 3x5W-240V+ 3xL007

#### ACCESSORI / ACCESSORIES

**L007** LED GU10 Ø35mm LED 3.2W-220-240V

**4191T-00** Testate Di Chiusura / End caps / Endkappen / Tête de fermeture

\*= Altezza inclusa lampadina GU10 Ø35mm H45mm e portalampada / Height including GU10 Ø35mm H45mm lamp and lampholder / Höhe inkl. GU10 Ø35 mm H45 mm Lampe und Fassung / Hauteur compris ampoule GU10 Ø35 mm H45 mm et source

\*\*= Effettuare il foro ad "L" / Carry out an "L" shape cut / Führen Sie einen "L" -Formschnitt durch / Effectuer une coupe à "L"

#### DATI TECNICI / TECHNICAL DATA

**4191X-35** GU10 Ø35 MAX 2x5W-240V

Versione con lampadina inclusa / Version with bulb included  
Version mit Lampe enthalten / Version avec ampoule incluse:

**4191X-35-L** GU10 Ø35 MAX 2x5W-240V + 2xL007

#### ACCESSORI / ACCESSORIES

**L007** LED GU10 Ø35mm LED 3.2W-220-240V

**4191T-00** Testate Di Chiusura / End caps / Endkappen / Tête de fermeture

\*= Altezza inclusa lampadina GU10 Ø35mm H45mm e portalampada / Height including GU10 Ø35mm H45mm lamp and lampholder / Höhe inkl. GU10 Ø35 mm H45 mm Lampe und Fassung / Hauteur compris ampoule GU10 Ø35 mm H45 mm et source

\*\*= Effettuare il foro ad "L" / Carry out an "L" shape cut / Führen Sie einen "L" -Formschnitt durch / Effectuer une coupe à "L"

# 4191K

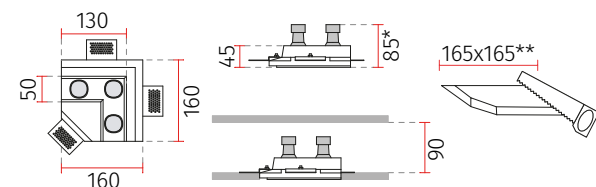

# 4191X

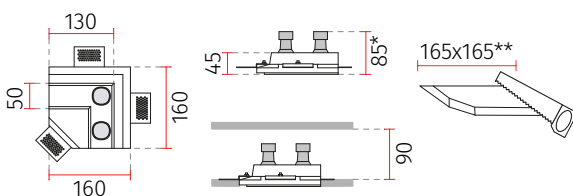

# INCASSO A PLAFONE

## Ceiling recessed lighting

### Decken-Einbauleuchten

### Encastrés Plafonds

CRISTALY®

made in Italy

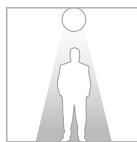

Art. 4196D / 4196H / 4196N



#### DATI TECNICI / TECHNICAL DATA

**4196D-35** GU10 Ø35 MAX 4x5W-240V

Versione con lampadina inclusa / Version with bulb included  
Version mit Lampe enthalten / Version avec ampoule incluse:

**4196D-35-L** GU10 Ø35 MAX 4x5W-240V + 4xL007

#### ACCESSORI / ACCESSORIES

**L007** LED GU10 Ø35mm LED 3.2W-220-240V

**023.457** Controcassa per muratura / Housing box for brickwork / Einbaugehäuse für Betonwand / Boîtier pour béton/briques [295x155x115mm]

# 4196D



1,7 Kg

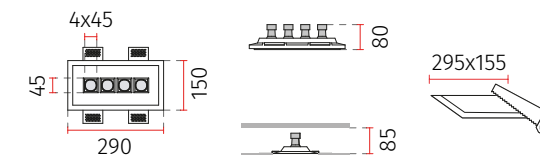

#### DATI TECNICI / TECHNICAL DATA

**4196H-35** GU10 Ø35 MAX 8x5W-240V

Versione con lampadina inclusa / Version with bulb included  
Version mit Lampe enthalten / Version avec ampoule incluse:

**4196H-35-L** GU10 Ø35 MAX 8x5W-240V+ 8xL007

#### ACCESSORI / ACCESSORIES

**L007** LED GU10 Ø35mm LED 3.2W-220-240V

**023.4004** Controcassa per muratura / Housing box for brickwork / Einbaugehäuse für Betonwand / Boîtier pour béton/briques [555x145x85mm]

# 4196H



2,8 Kg

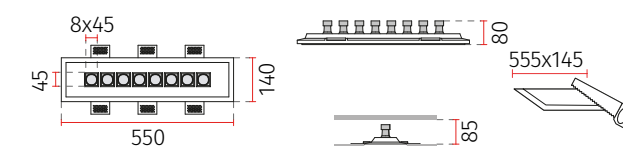

#### DATI TECNICI / TECHNICAL DATA

**4196N-35** GU10 Ø35 MAX 12x5W-240V

Versione con lampadina inclusa / Version with bulb included  
Version mit Lampe enthalten / Version avec ampoule incluse:

**4196N-35-L** GU10 Ø35 MAX 12x5W-240V+ 12xL007

#### ACCESSORI / ACCESSORIES

**L007** LED GU10 Ø35mm LED 3.2W-220-240V

**023.4005** Controcassa per muratura / Housing box for brickwork / Einbaugehäuse für Betonwand / Boîtier pour béton/briques [705x145x80mm]

# 4196N



3,5 Kg

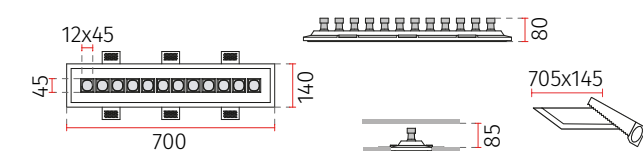

IT Misure espresse in mm, tolleranza +/- 1-2 mm. L'azienda si riserva la facoltà di apportare variazioni di dati caratteristici, materiali, design, stili, tonalità, senza alcun preavviso.  
EN Measures in mm, tolerance +/- 1/2 mm. The company reserves the right to carry out variations to technical details, materials, design, style, colors with no previous notice.

DE Die Masse sind in mm, mit einer Tolleranz von +/- 1-2 mm ausgedrückt, Die Firma behält sich das Recht vor ohne Voranmeldung Änderungen an den Werkstoffen, am Design, am Stil und an der Färbung vorzunehmen.  
FR Mesures en mm, tolérance +/- 1/2 mm. La société se réserve le droit de modifier sans préavis les détails techniques, les matériaux, le design, le style et les couleurs.

# INCASSO A PLAFONE

## Ceiling recessed lighting

### Decken-Einbauleuchten

### Encastrés Plafonds

CRISTALY®

made in Italy

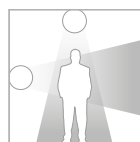

#### DATI TECNICI / TECHNICAL DATA

4197A-00	L400 - Senza parte elettrica / Without electrical part / Ohne elektrischen Teil / Sans partie électrique
4197B-00	L800 - Senza parte elettrica / Without electrical part / Ohne elektrischen Teil / Sans partie électrique /
4197C-00	L 1200 - Senza parte elettrica / Without electrical part / Ohne elektrischen Teil / Sans partie électrique

LED= MAX 30W/m

NEW

4197



Strip LED con copertura opalina 029.005  
Strip LED with opal cover 029.005  
LED Bänder mit opale Abdeckung 029.005  
Rubans LED avec couverture opale 029.005

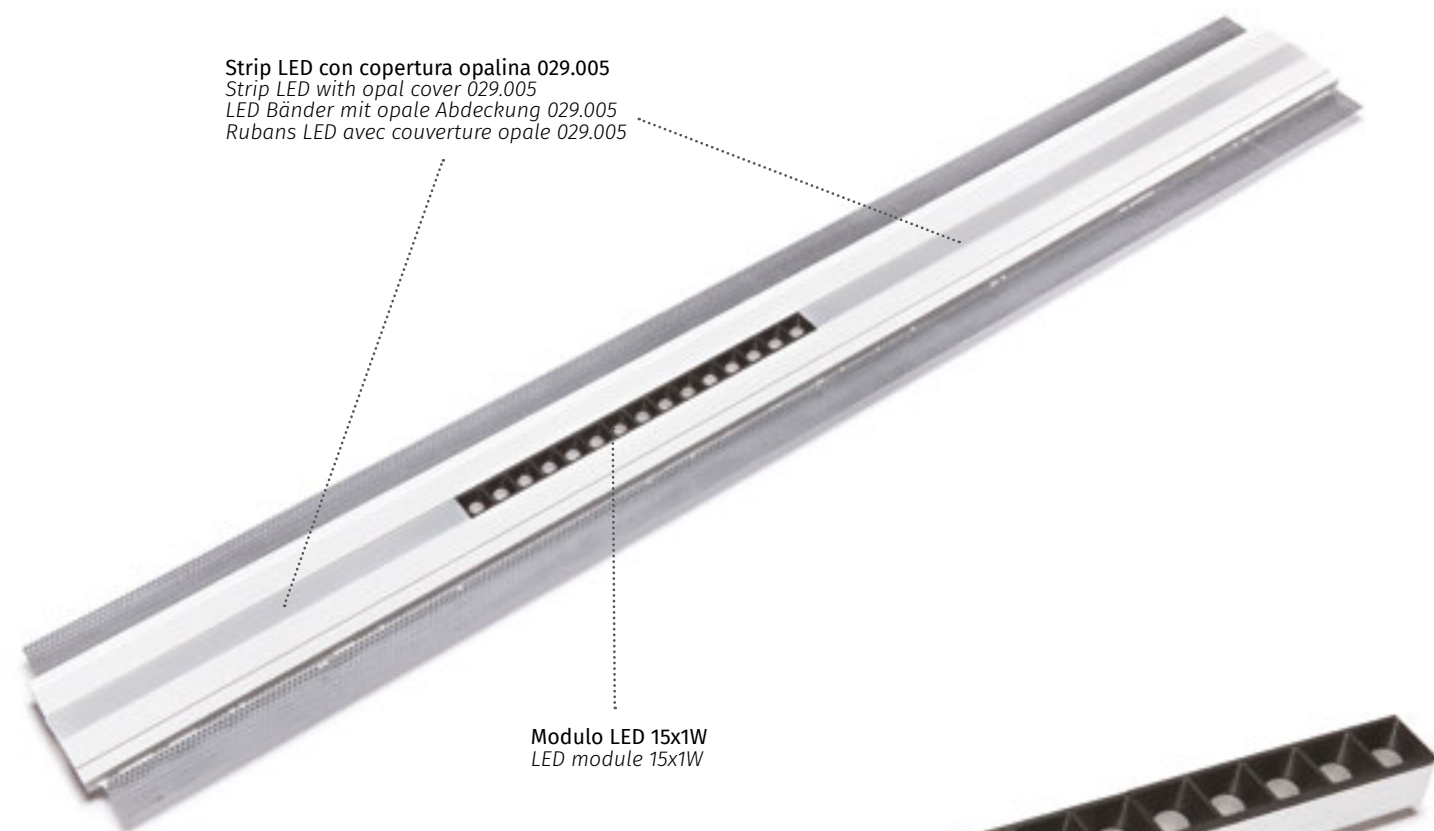

Modulo LED 15x1W  
LED module 15x1W

099.704:  
LED 15x1W-24Vdc-500lm-3000°K-CRI90 -  
Nero / Black / Schwarz / Noir

099.705:  
LED 5x1W-24Vdc-500lm-3000°K-CRI90 -  
Bianco / White / Weiss / Blanc

Codice Code			
4197A-00	400	125x405	2,3 Kg
4197B-00	800	125x805	4,6 Kg
4197C-00	1200	125x1205	6,9 Kg

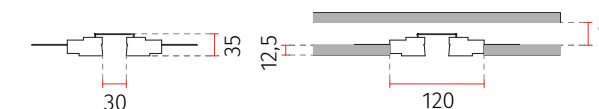

#### 4197A - 4197B - 4197C:

Incluso nella confezione:  
- Profilo in CRISTALY®

Da ordinare separatamente:  
- Strip LED  
- Moduli LED 5x1W / 15x1W  
- Testate di chiusura  
- Schermo opalino

EN Included in the packaging:  
- CRISTALY® profile

To be ordered separately:  
- Strip LED  
- LED module 5x1W - 15x1W  
- End caps  
- Opal plastic cover

DE In der verpackung ist einbegriffen:  
- CRISTALY® profil

Separat zu bestellen:  
- LED Bänder  
- LED Module 5x1W - 15x1W  
- Endkappen  
- Abdeckung in opal-methacrylat

FR Dans le colisage est inclus:  
- profilé en CRISTALY®

À commander séparément :  
- Ruban LED  
- Module LED 5x1W - 15x1W  
- Bouchons de terminaux  
- Diffuseur en pmma opale

#### ACCESSORI / ACCESSORIES

LED Strip		Pg. 398
099.703		LED 5x1W-24Vdc-500lm-3000°K-CRI90 - Nero / Black / Schwarz / Noir
099.704		LED 15x1W-24Vdc-1500lm-3000°K-CRI90 - Nero / Black / Schwarz / Noir
099.705		LED 5x1W-24Vdc-500lm-3000°K-CRI90 - Bianco / White / Weiss / Blanc
099.706		LED 15x1W-24Vdc-1500lm-3000°K-CRI90 - Bianco / White / Weiss / Blanc
4197T-00		Testate di chiusura / End caps / Endkappen / Bouchons de terminaux
029.005		Schermo opalino / Opal plastic cover / Abdeckung in Opalen-Kunststoff / Diffuseur en pmma opale

IT Misure espresse in mm, tolleranza +/- 1-2 mm. L'azienda si riserva la facoltà di apportare variazioni di dati caratteristici, materiali, design, stili, tonalità, senza alcun preavviso.  
EN Measures in mm, tolerance +/- 1/2 mm. The company reserves the right to carry out variations to technical details, materials, design, style, colors with no previous notice.

DE Die Masse sind in mm, mit einer Tolleranz von +/- 1-2 mm ausgedrückt, Die Firma behält sich das Recht vor ohne Voranmeldung Änderungen an den Werkstoffen, am Design, am Stil und an der Färbung vorzunehmen.  
FR Mesures en mm, tolérance +/- 1/2 mm. La société se réserve le droit de modifier sans préavis les détails techniques, les matériaux, le design, le style et les couleurs.



## PROGETTA CON LA LUCE

**DIREZIONABILI**  
ADJUSTABLE

**PERSONALIZZABILI**  
CUSTOMIZABLE

**VALORIZZA L'AMBIENTE**  
ENHANCE THE ENVIRONMENT

Faretti da incasso dal design essenziale e funzionale: sono inclinabili e adatti all'illuminazione di accento, per valorizzare colori e sfumature degli ambienti da illuminare. La peculiarità della linea di incasso colorabile li rende una fresca novità.

EN Recessed spotlights with an essential and functional design. They can be inclined and are suitable for accent lighting, and also enhance the colours and shades of the rooms to be illuminated. The peculiarity of the colourable recessed line makes it a bright novelty.

DE Einbau-Strahler mit wesentlichem, funktionellem Design. Sie sind schwenkbar und eignen sich für die Akzentbeleuchtung zur Hervorhebung von Farben und Nuancen der zu beleuchtenden Räume. Diese besondere Einbaureihe ist anstreichbar und somit eine frische Neuheit.

FR Spots à encastrer au design essentiel et fonctionnel : ils sont inclinables et adaptés pour l'éclairage d'accentuation, afin de valoriser les couleurs et les nuances des pièces à éclairer. La particularité de la gamme à encastrer colorée en fait une nouveauté rafraîchissante.



A

**Corpo CRISTALY®**  
CRISTALY® frame  
CRISTALY®-Rahmen  
Cadre CRISTALY®

B

**Scocca in metallo verniciato nero opaco**  
Black matt painted metal shell  
Schwarz matt lackierte Metallschale  
Coque en métal peint noir mat

C

**Basculante di 30°+30° e orientabile a 360°**  
Tilttable 30° + 30° and adjustable 360°  
Schwenkbar von 30° + 30° und Einstellbar 360°  
Orientable à 30° + 30° et pivotable à 360°

D

**Fascetta decorabile a piacere**  
Paintable clamp  
Lackierbare Klammer  
Pince à peindre



D

# A PLAFONE

Ceiling lighting  
Deckenleuchten  
Plafonniers

CRISTALY®

made in Italy

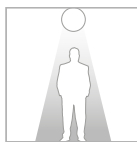

Art. 4246A/4246C

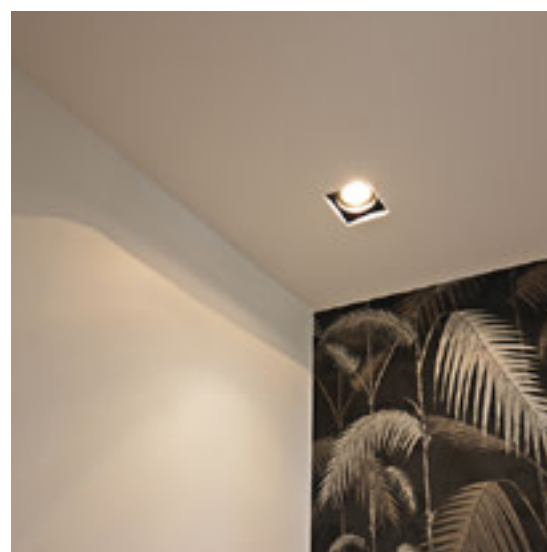

Lampadina orientabile di 360°  
Adjustable spotlight 360°  
Schwenkbares Leuchtmittel 360°  
Ampoule pivotante 360°



IT Misure espresse in mm, tolleranza +/- 1-2 mm. L'azienda si riserva la facoltà di apportare variazioni di dati caratteristici, materiali, design, stili, tonalità, senza alcun preavviso.  
EN Measures in mm, tolerance +/- 1/2 mm. The company reserves the right to carry out variations to technical details, materials, design, style, colors with no previous notice.

## DATI TECNICI / TECHNICAL DATA

4246A-35 GU10 Ø50 MAX 10W-240V

## ACCESSORI / ACCESSORIES

023.4014 Controcassa per muratura / Housing box for brickwork / Einbauehäuse für Betonwand / Boîtier pour béton/briques [155x155x140mm]

021.231 Portalamпада / Lampholder / Lampenfassung / Source GU5.3

NEW 4246A

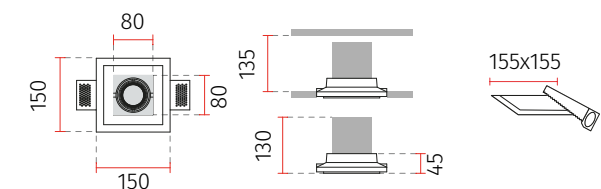

## DATI TECNICI / TECHNICAL DATA

4246C-35 GU10 Ø50 MAX 3x10W-240V

## ACCESSORI / ACCESSORIES

023.4015 Controcassa per muratura / Housing box for brickwork / Einbauehäuse für Betonwand / Boîtier pour béton/briques [155x325x140mm]

021.231 Portalamпада / Lampholder / Lampenfassung / Source GU5.3

NEW 4246C

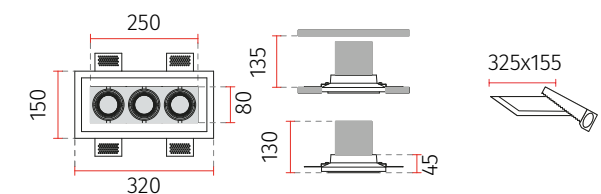

## DATI TECNICI / TECHNICAL DATA

4246E-35 GU10 Ø50 MAX 5x10W-240V

## ACCESSORI / ACCESSORIES

023.4016 Controcassa per muratura / Housing box for brickwork / Einbauehäuse für Betonwand / Boîtier pour béton/briques [155x495x140mm]

021.231 Portalamпада / Lampholder / Lampenfassung / Source GU5.3

NEW 4246E

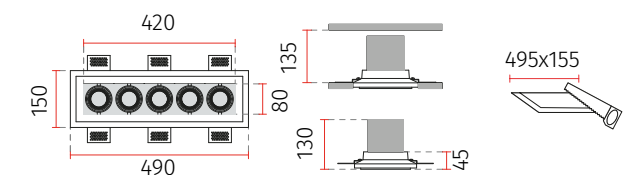

DE Die Masse sind in mm, mit einer Tolleranz von +/- 1-2 mm ausgedrückt, Die Firma behält sich das Recht vor ohne Voranmeldung Änderungen an den Werkstoffen, am Design, am Stil und an der Färbung vorzunehmen.  
FR Mesures en mm, tolérance +/- 1/2 mm. La société se réserve le droit de modifier sans préavis les détails techniques, les matériaux, le design, le style et les couleurs.

# SUPERARE L'IMPOSSIBILE

Oltre l'impossibile, è dove siamo arrivati con i miniled rinnovati nelle due versioni con foro da Ø16 mm e Ø11 mm.

- Il 16mm con un rapporto diametro foro/lumen/ingombri unico al mondo e frutto di brevetti depositati in esclusiva da 9010.
- L' 11mm con un sistema magnetico di manutenzione innovativo e rapidissimo, in corso di brevetto.

Un vero e proprio concentrato di tecnologia: installazione in soli 30 mm di spazio.

**EN** We have achieved the impossible with the new mini LED lights in two versions with Ø16 mm and Ø11 mm holes. The 16 mm version, with an unrivalled hole diameter/lumen/overall size ratio, is the result of exclusive patents by 9010. The patent for the 11 mm version, with innovative and ultra-rapid magnetic maintenance system, is pending. Packed with powerful technology: installation in just 30 mm of space

**DE** Ein fast unmögliches Ziel haben wir mit den Minileds in den beiden erneuerten Versionen mit Bohrung Ø16 mm und Ø11 mm erreicht. Die 16 mm Ausführung mit einem einzigartigen Bohrung/Lumen/Raumbedarf-Verhältnis ist das Ergebnis der Exklusivpatente von 9010. Die 11 mm Ausführung mit einem innovativen und superschnellen Magnetwartungssystem ist zum Patent angemeldet. Ein authentisches technologisches Konzentrat: installation in lediglich 30 mm

**FR** Nous avons réalisé l'impossible avec les nouveaux mini LED en deux versions, avec trou de Ø16 mm et Ø11 mm. Le 16 mm avec un rapport diamètre du trou/lumen/encombrements unique au monde et est le résultat de brevets exclusifs de 9010. Le 11 mm avec un système magnétique d'entretien innovant et extrêmement rapide, avec brevet en cours de dépôt. Un véritable concentré de technologie: installation dans un espace de 30 mm seulement



1:1

**A**

**Foro luce Ø16mm o Ø11mm**

*Light hole Ø16mm or Ø11mm  
Bohrung Ø16mm oder Ø11mm  
Trou lumière Ø16mm ou Ø11mm*

**B**

**Grado di protezione IP44**

*IP44 degree of protection  
Schutzart IP44  
Degré de protection IP44*

**C**

**Installazione in 30mm spazio interno al cartongesso**

*Installation in 30mm space inside the plasterboard  
Installation in 30 mm Abstand innerhalb der Gipsplatte  
Installation dans un espace de 30mm à l'intérieur de la plaque de plâtre*

**D**

**Due fasci di apertura 30°/60°**

*Two 30° / 60° beam angle  
Zwei Öffnungswinkel von 30° / 60°  
Deux angles de faisceau de 30° / 60°*

**E**

**LED 1300lm (3000K) con CRI>90 e lente protettiva in vetro**

*LED 1300lm (3000K) with CRI> 90 and glass protective lens  
LED 1300lm (3000K) mit CRI> 90 und Glas Schutzlinse  
LED 1300lm (3000K) avec CRI> 90 et lentille de protection en verre*

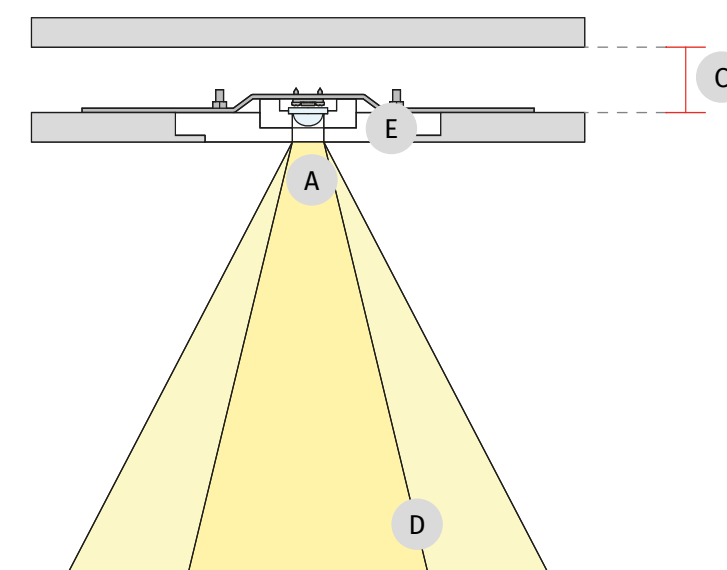

**MINIMO SPAZIO**  
MINIMUM SPACE

**FLESSIBILITÀ D'UTILIZZO**  
FLEXIBILITY OF USE

**MASSIMA LUCE**  
MAXIMUM LIGHT

# INCASSO A PLAFONE

## Ceiling recessed lighting

### Decken-Einbauleuchten

### Encastrés Plafonds

CRISTALY<sup>®</sup> made in Italy

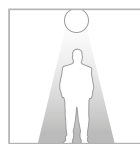

LED ispezionabile senza lavori di muratura  
LED maintenance without masonry work  
LED-Wartung ohne Mauerwerk  
Entretien des LED sans travaux de maçonnerie



PATENT PENDING

4247A NEW

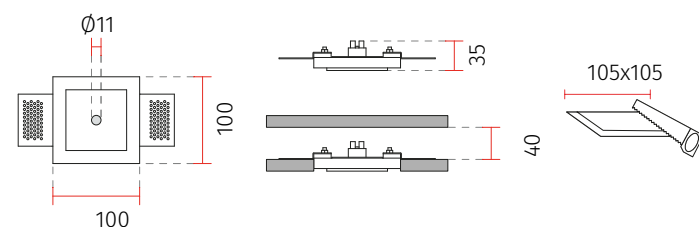

DATI TECNICI / TECHNICAL DATA	
4247A-3000	LED 2W-24Vdc-200lm-3000°K-CRI90
4247A-2700	LED 2W-24Vdc-190lm-2700°K-CRI90
4247A-4000	LED 2W-24Vdc-210lm-4000°K-CRI90
026.258	DRIVER ON/OFF 12W 24V
026.259	DRIVER ON/OFF 36W 24V
026.260	DRIVER ON/OFF 60W 24V
026.219	DRIVER DIM PUSH/0-10V/DALI 21.6W 24V
026.209	DRIVER DIM PUSH/1-10V 60W 24V

ACCESSORI / ACCESSORIES	
023.450	Controcassa per muratura / Housing box for brickwork / Einbaugeschäuse für Betonwand / Boîtier pour béton/briques [105x105x65mm]
099.142	Pg.415 Kit emergenza / Emergency Kit

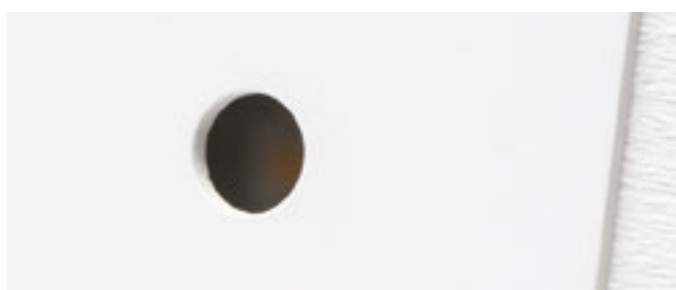

DATI TECNICI / TECHNICAL DATA	
4249A-3000	LED 2W-24Vdc-200lm-3000°K-CRI90
4249A-2700	LED 2W-24Vdc-190lm-2700°K-CRI90
4249A-4000	LED 2W-24Vdc-210lm-4000°K-CRI90
026.258	DRIVER ON/OFF 12W 24V
026.259	DRIVER ON/OFF 36W 24V
026.260	DRIVER ON/OFF 60W 24V
026.219	DRIVER DIM PUSH/0-10V/DALI 21.6W 24V
026.209	DRIVER DIM PUSH/1-10V 60W 24V

ACCESSORI / ACCESSORIES	
023.450	Controcassa per muratura / Housing box for brickwork / Einbaugeschäuse für Betonwand / Boîtier pour béton/briques [105x105x65mm]
099.142	Pg.415 Kit emergenza / Emergency Kit



NEW 4249A

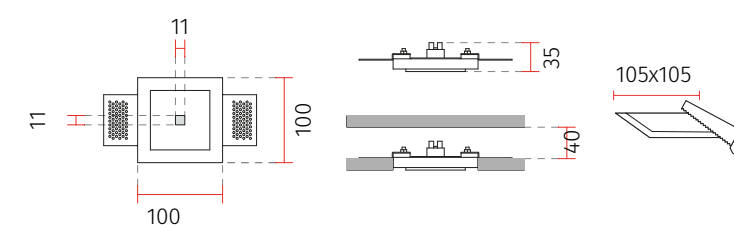

4248A NEW

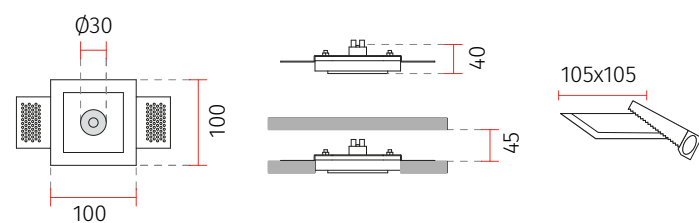

DATI TECNICI / TECHNICAL DATA	
4248A-3000	LED 2W-24Vdc-200lm-3000°K-CRI90
4248A-2700	LED 2W-24Vdc-190lm-2700°K-CRI90
4248A-4000	LED 2W-24Vdc-210lm-4000°K-CRI90
026.258	DRIVER ON/OFF 12W 24V
026.259	DRIVER ON/OFF 36W 24V
026.260	DRIVER ON/OFF 60W 24V
026.219	DRIVER DIM PUSH/0-10V/DALI 21.6W 24V
026.209	DRIVER DIM PUSH/1-10V 60W 24V

ACCESSORI / ACCESSORIES	
023.450	Controcassa per muratura / Housing box for brickwork / Einbaugeschäuse für Betonwand / Boîtier pour béton/briques [105x105x65mm]
099.142	Pg.415 Kit emergenza / Emergency Kit

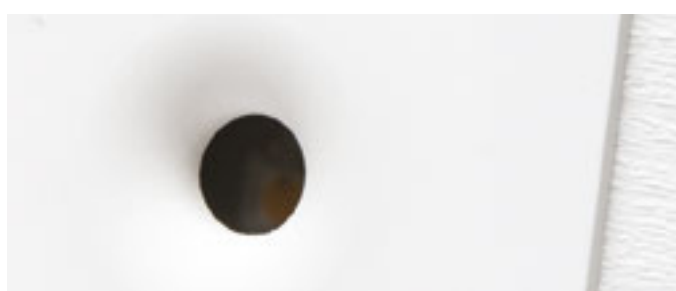

DATI TECNICI / TECHNICAL DATA	
4250A-3000	LED 2W-24Vdc-200lm-3000°K-CRI90
4250A-2700	LED 2W-24Vdc-190lm-2700°K-CRI90
4250A-4000	LED 2W-24Vdc-210lm-4000°K-CRI90
026.258	DRIVER ON/OFF 12W 24V
026.259	DRIVER ON/OFF 36W 24V
026.260	DRIVER ON/OFF 60W 24V
026.219	DRIVER DIM PUSH/0-10V/DALI 21.6W 24V
026.209	DRIVER DIM PUSH/1-10V 60W 24V

ACCESSORI / ACCESSORIES	
023.450	Controcassa per muratura / Housing box for brickwork / Einbaugeschäuse für Betonwand / Boîtier pour béton/briques [105x105x65mm]
099.142	Pg.415 Kit emergenza / Emergency Kit



NEW 4250A

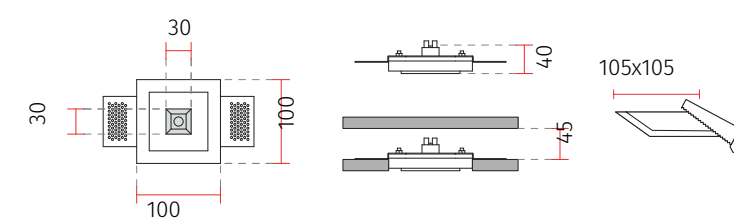

IT Misure espresse in mm, tolleranza +/- 1-2 mm. L'azienda si riserva la facoltà di apportare variazioni di dati caratteristici, materiali, design, stili, tonalità, senza alcun preavviso.  
EN Measures in mm, tolerance +/- 1/2 mm. The company reserves the right to carry out variations to technical details, materials, design, style, colors with no previous notice.

DE Die Masse sind in mm, mit einer Tolleranz von +/- 1-2 mm ausgedrückt, Die Firma behält sich das Recht vor ohne Voranmeldung Änderungen an den Werkstoffen, am Design, am Stil und an der Färbung vorzunehmen.  
FR Mesures en mm, tolérance +/- 1/2 mm. La société se réserve le droit de modifier sans préavis les détails techniques, les matériaux, le design, le style et les couleurs.





# INCASSO A PLAFONE

## Ceiling recessed lighting

### Decken-Einbauleuchten

### Encastrés Plafonds

**PATENT  
PENDING**

CRISTALY®

made in Italy

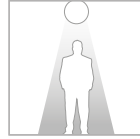

LED ispezionabile senza lavori di muratura  
LED maintenance without masonry work  
LED-Wartung ohne Mauerwerk  
Entretien des LED sans travaux de maçonnerie

Art. 4247E - Private house - Vicenza, Italy  
Arch. Stefano Lucato



#### DATI TECNICI / TECHNICAL DATA

4247E-30150	LED 4W-200mA-450lm-3000°K-CRI90-60°
4247E-27150	LED 4W-200mA-430lm-2700°K-CRI90-60°
4247E-40150	LED 4W-200mA-470lm-4000°K-CRI90-60°
4247E-30153	LED 4W-200mA-450lm-3000°K-CRI90-30°
4247E-27153	LED 4W-200mA-430lm-2700°K-CRI90-30°
4247E-40153	LED 4W-200mA-470lm-4000°K-CRI90-30°
026.218	DRIVER ON/OFF 8W 200mA
026.219	DRIVER DIM PUSH/0-10V/DALI 9.2W 200mA
4247E-30151	LED 6.5W-350mA-650lm-3000°K-CRI90-60°
4247E-27151	LED 6.5W-350mA-620lm-2700°K-CRI90-60°
4247E-40151	LED 6.5W-350mA-680lm-4000°K-CRI90-60°
4247E-30154	LED 6.5W-350mA-650lm-3000°K-CRI90-30°
4247E-27154	LED 6.5W-350mA-620lm-2700°K-CRI90-30°
4247E-40154	LED 6.5W-350mA-680lm-4000°K-CRI90-30°
026.251	DRIVER ON/OFF min6W max8.8W 350mA
026.252	DRIVER ON/OFF min12.6W max18.2W 350mA
026.221	DRIVER ON/OFF min9.8W max35W 350mA
026.219	DRIVER DIM PUSH/0-10V/DALI 16.1W 350mA
026.187	DRIVER DIM 0-10V 35W 350mA
026.185	DRIVER DIM PUSH/DALI 35W 350mA
4247E-30152	LED 13W-700mA-1300lm-3000°K-CRI90-60°
4247E-27152	LED 13W-700mA-1250lm-2700°K-CRI90-60°
4247E-40152	LED 13W-700mA-1350lm-4000°K-CRI90-60°
4247E-30155	LED 13W-700mA-1300lm-3000°K-CRI90-30°
4247E-27155	LED 13W-700mA-1250lm-2700°K-CRI90-30°
4247E-40155	LED 13W-700mA-1350lm-4000°K-CRI90-30°
026.255	DRIVER ON/OFF min11.9W max18.2W 700mA
026.256	DRIVER ON/OFF min24.9W max35.7W 700mA
026.219	DRIVER DIM PUSH/0-10V/DALI 19.6W 700mA
026.207	DRIVER DIM 0-10V 60.2W 700mA
026.206	DRIVER DIM PUSH/DALI 60.2W 700mA

#### ACCESSORI / ACCESSORIES

023.4010	Controcassa per muratura / Housing box for brickwork / Einbaugeschäuse für Betonwand / Boîtier pour béton/briques [235x140x45mm]
099.142	Pg.415 Kit emergenza / Emergency Kit

NEW  **4247E**



 0,6 Kg

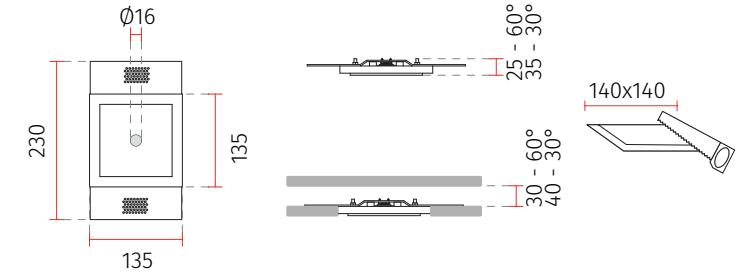

# INCASSO A PLAFONE

## Ceiling recessed lighting

### Decken-Einbauleuchten

### Encastrés Plafonds

**PATENT  
PENDING**

CRISTALY®

made in Italy

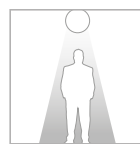

LED ispezionabile senza lavori di muratura  
LED maintenance without masonry work  
LED-Wartung ohne Mauerwerk  
Entretien des LED sans travaux de maçonnerie



# 4248E

NEW

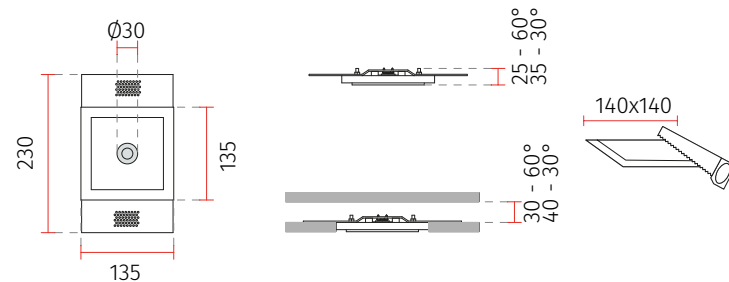

#### DATI TECNICI / TECHNICAL DATA

4248E-30150	LED 4W-200mA-450lm-3000°K-CRI90-60°
4248E-27150	LED 4W-200mA-430lm-2700°K-CRI90-60°
4248E-40150	LED 4W-200mA-470lm-4000°K-CRI90-60°
4248E-30153	LED 4W-200mA-450lm-3000°K-CRI90-30°
4248E-27153	LED 4W-200mA-430lm-2700°K-CRI90-30°
4248E-40153	LED 4W-200mA-470lm-4000°K-CRI90-30°
026.218	DRIVER ON/OFF 8W 200mA
026.219	DRIVER DIM PUSH/0-10V/DALI 9.2W 200mA
4248E-30151	LED 6.5W-350mA-650lm-3000°K-CRI90-60°
4248E-27151	LED 6.5W-350mA-620lm-2700°K-CRI90-60°
4248E-40151	LED 6.5W-350mA-680lm-4000°K-CRI90-60°
4248E-30154	LED 6.5W-350mA-650lm-3000°K-CRI90-30°
4248E-27154	LED 6.5W-350mA-620lm-2700°K-CRI90-30°
4248E-40154	LED 6.5W-350mA-680lm-4000°K-CRI90-30°
026.251	DRIVER ON/OFF min6W max8.8W 350mA
026.252	DRIVER ON/OFF min12.6W max18.2W 350mA
026.221	DRIVER ON/OFF min9.8W max35W 350mA
026.219	DRIVER DIM PUSH/0-10V/DALI 16.1W 350mA
026.187	DRIVER DIM 0-10V 35W 350mA
026.185	DRIVER DIM PUSH/DALI 35W 350mA
4248E-30152	LED 13W-700mA-1300lm-3000°K-CRI90-60°
4248E-27152	LED 13W-700mA-1250lm-2700°K-CRI90-60°
4248E-40152	LED 13W-700mA-1350lm-4000°K-CRI90-60°
4248E-30155	LED 13W-700mA-1300lm-3000°K-CRI90-30°
4248E-27155	LED 13W-700mA-1250lm-2700°K-CRI90-30°
4248E-40155	LED 13W-700mA-1350lm-4000°K-CRI90-30°
026.255	DRIVER ON/OFF min11.9W max18.2W 700mA
026.256	DRIVER ON/OFF min24.9W max35.7W 700mA
026.219	DRIVER DIM PUSH/0-10V/DALI 19.6W 700mA
026.207	DRIVER DIM 0-10V 60.2W 700mA
026.206	DRIVER DIM PUSH/DALI 60.2W 700mA

#### ACCESSORI / ACCESSORIES

023.4010	Controcassa per muratura / Housing box for brickwork / Einbaugeschäuse für Betonwand / Boîtier pour béton/briques [235x140x45mm]
099.142	Pg.415 Kit emergenza / Emergency Kit



#### DATI TECNICI / TECHNICAL DATA

4248F-30150	LED 2x4W-200mA-900lm-3000°K-CRI90-60°
4248F-27150	LED 2x4W-200mA-860lm-2700°K-CRI90-60°
4248F-40150	LED 2x4W-200mA-940lm-4000°K-CRI90-60°
4248F-30153	LED 2x4W-200mA-900lm-3000°K-CRI90-30°
4248F-27153	LED 2x4W-200mA-860lm-2700°K-CRI90-30°
4248F-40153	LED 2x4W-200mA-940lm-4000°K-CRI90-30°
026.218	DRIVER ON/OFF 8W 200mA
026.219	DRIVER DIM PUSH/0-10V/DALI 9.2W 200mA
4248F-30151	LED 2x6.5W-350mA-1300lm-3000°K-CRI90-60°
4248F-27151	LED 2x6.5W-350mA-1240lm-2700°K-CRI90-60°
4248F-40151	LED 2x6.5W-350mA-1360lm-4000°K-CRI90-60°
4248F-30154	LED 2x6.5W-350mA-1300lm-3000°K-CRI90-30°
4248F-27154	LED 2x6.5W-350mA-1240lm-2700°K-CRI90-30°
4248F-40154	LED 2x6.5W-350mA-1360lm-4000°K-CRI90-30°
026.252	DRIVER ON/OFF min12.6W max18.2W 350mA
026.221	DRIVER ON/OFF min9.8W max35W 350mA
026.219	DRIVER DIM PUSH/0-10V/DALI 16.1W 350mA
026.187	DRIVER DIM 0-10V 35W 350mA
026.185	DRIVER DIM PUSH/DALI 35W 350mA

#### ACCESSORI / ACCESSORIES

023.4011	Controcassa per muratura / Housing box for brickwork / Einbaugeschäuse für Betonwand / Boîtier pour béton/briques [305x140x45mm]
099.142	Pg.415 Kit emergenza / Emergency Kit

# 4248F

NEW

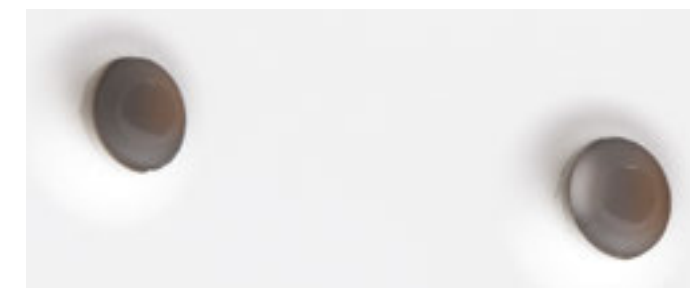
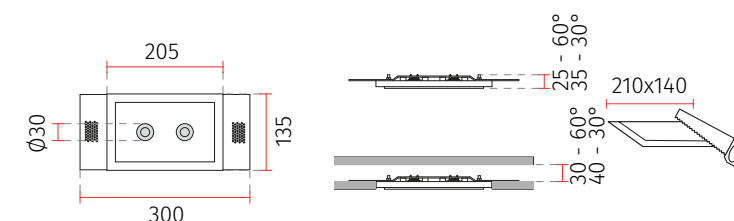

# INCASSO A PLAFONE

Ceiling recessed lighting  
Decken-Einbauleuchten  
Encastrés Plafonds

**PATENT  
PENDING**

CRISTALY®

made in Italy

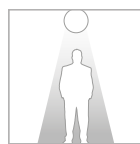

LED ispezionabile senza lavori di muratura  
LED maintenance without masonry work  
LED-Wartung ohne Mauerwerk  
Entretien des LED sans travaux de maçonnerie



## 4249E



NEW



0,6 Kg

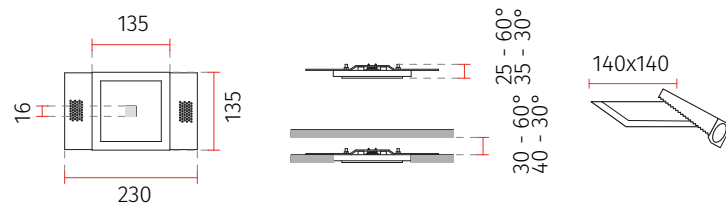

### DATI TECNICI / TECHNICAL DATA

4249E-30150	LED 4W-200mA-450lm-3000°K-CRI90-60°
4249E-27150	LED 4W-200mA-430lm-2700°K-CRI90-60°
4249E-40150	LED 4W-200mA-470lm-4000°K-CRI90-60°
4249E-30153	LED 4W-200mA-450lm-3000°K-CRI90-30°
4249E-27153	LED 4W-200mA-430lm-2700°K-CRI90-30°
4249E-40153	LED 4W-200mA-470lm-4000°K-CRI90-30°
026.218	DRIVER ON/OFF 8W 200mA
026.219	DRIVER DIM PUSH/0-10V/DALI 9.2W 200mA
4249E-30151	LED 6.5W-350mA-650lm-3000°K-CRI90-60°
4249E-27151	LED 6.5W-350mA-620lm-2700°K-CRI90-60°
4249E-40151	LED 6.5W-350mA-680lm-4000°K-CRI90-60°
4249E-30154	LED 6.5W-350mA-650lm-3000°K-CRI90-30°
4249E-27154	LED 6.5W-350mA-620lm-2700°K-CRI90-30°
4249E-40154	LED 6.5W-350mA-680lm-4000°K-CRI90-30°
026.251	DRIVER ON/OFF min6W max8.8W 350mA
026.252	DRIVER ON/OFF min12.6W max18.2W 350mA
026.221	DRIVER ON/OFF min9.8W max35W 350mA
026.219	DRIVER DIM PUSH/0-10V/DALI 16.1W 350mA
026.187	DRIVER DIM 0-10V 35W 350mA
026.185	DRIVER DIM PUSH/DALI 35W 350mA
4249E-30152	LED 13W-700mA-1300lm-3000°K-CRI90-60°
4249E-27152	LED 13W-700mA-1250lm-2700°K-CRI90-60°
4249E-40152	LED 13W-700mA-1350lm-4000°K-CRI90-60°
4249E-30155	LED 13W-700mA-1300lm-3000°K-CRI90-30°
4249E-27155	LED 13W-700mA-1250lm-2700°K-CRI90-30°
4249E-40155	LED 13W-700mA-1350lm-4000°K-CRI90-30°
026.255	DRIVER ON/OFF min11.9W max18.2W 700mA
026.256	DRIVER ON/OFF min24.9W max35.7W 700mA
026.219	DRIVER DIM PUSH/0-10V/DALI 19.6W 700mA
026.207	DRIVER DIM 0-10V 60.2W 700mA
026.206	DRIVER DIM PUSH/DALI 60.2W 700mA

### ACCESSORI / ACCESSORIES

023.4010	Controcassa per muratura / Housing box for brickwork / Einbaugeschäuse für Betonwand / Boîtier pour béton/briques [235x140x45mm]
099.142	Pg.415 Kit emergenza / Emergency Kit

### DATI TECNICI / TECHNICAL DATA

4249F-30150	LED 2x4W-200mA-900lm-3000°K-CRI90-60°
4249F-27150	LED 2x4W-200mA-860lm-2700°K-CRI90-60°
4249F-40150	LED 2x4W-200mA-940lm-4000°K-CRI90-60°
4249F-30153	LED 2x4W-200mA-900lm-3000°K-CRI90-30°
4249F-27153	LED 2x4W-200mA-860lm-2700°K-CRI90-30°
4249F-40153	LED 2x4W-200mA-940lm-4000°K-CRI90-30°
026.218	DRIVER ON/OFF 8W 200mA
026.219	DRIVER DIM PUSH/0-10V/DALI 9.2W 200mA
4249F-30151	LED 2x6.5W-350mA-1300lm-3000°K-CRI90-60°
4249F-27151	LED 2x6.5W-350mA-1240lm-2700°K-CRI90-60°
4249F-40151	LED 2x6.5W-350mA-1360lm-4000°K-CRI90-60°
4249F-30154	LED 2x6.5W-350mA-1300lm-3000°K-CRI90-30°
4249F-27154	LED 2x6.5W-350mA-1240lm-2700°K-CRI90-30°
4249F-40154	LED 2x6.5W-350mA-1360lm-4000°K-CRI90-30°
026.252	DRIVER ON/OFF min12.6W max18.2W 350mA
026.221	DRIVER ON/OFF min9.8W max35W 350mA
026.219	DRIVER DIM PUSH/0-10V/DALI 16.1W 350mA
026.187	DRIVER DIM 0-10V 35W 350mA
026.185	DRIVER DIM PUSH/DALI 35W 350mA

### ACCESSORI / ACCESSORIES

023.4011	Controcassa per muratura / Housing box for brickwork / Einbaugeschäuse für Betonwand / Boîtier pour béton/briques [305x140x45mm]
099.142	Pg.415 Kit emergenza / Emergency Kit

## 4249F



NEW



0,8 Kg

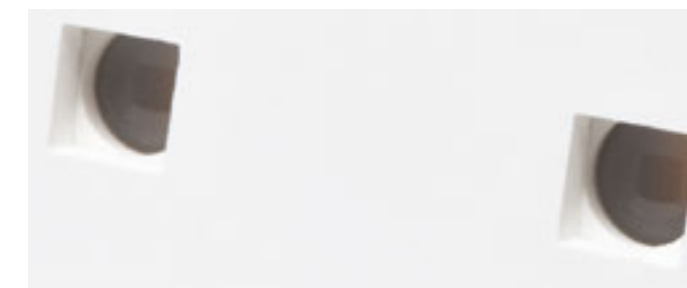
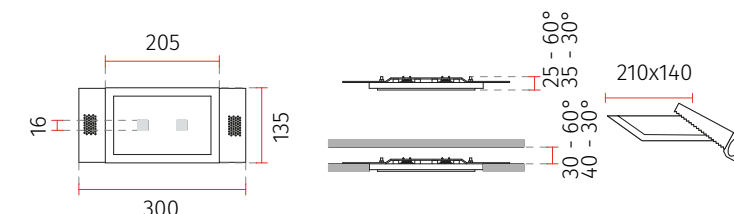



# INCASSO A PLAFONE

## Ceiling recessed lighting

### Decken-Einbauleuchten

### Encastrés Plafonds

**PATENT  
PENDING**

CRISTALY®

made in Italy

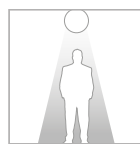

LED ispezionabile senza lavori di muratura  
LED maintenance without masonry work  
LED-Wartung ohne Mauerwerk  
Entretien des LED sans travaux de maçonnerie

Art. 4250E - Private house - Rennes, France



#### DATI TECNICI / TECHNICAL DATA

4250E-30150	LED 4W-200mA-450lm-3000°K-CRI90-60°
4250E-27150	LED 4W-200mA-430lm-2700°K-CRI90-60°
4250E-40150	LED 4W-200mA-470lm-4000°K-CRI90-60°
4250E-30153	LED 4W-200mA-450lm-3000°K-CRI90-30°
4250E-27153	LED 4W-200mA-430lm-2700°K-CRI90-30°
4250E-40153	LED 4W-200mA-470lm-4000°K-CRI90-30°
026.218	DRIVER ON/OFF 8W 200mA
026.219	DRIVER DIM PUSH/0-10V/DALI 9.2W 200mA
4250E-30151	LED 6.5W-350mA-650lm-3000°K-CRI90-60°
4250E-27151	LED 6.5W-350mA-620lm-2700°K-CRI90-60°
4250E-40151	LED 6.5W-350mA-680lm-4000°K-CRI90-60°
4250E-30154	LED 6.5W-350mA-650lm-3000°K-CRI90-30°
4250E-27154	LED 6.5W-350mA-620lm-2700°K-CRI90-30°
4250E-40154	LED 6.5W-350mA-680lm-4000°K-CRI90-30°
026.251	DRIVER ON/OFF min6W max8.8W 350mA
026.252	DRIVER ON/OFF min12.6W max18.2W 350mA
026.221	DRIVER ON/OFF min9.8W max35W 350mA
026.219	DRIVER DIM PUSH/0-10V/DALI 16.1W 350mA
026.187	DRIVER DIM 0-10V 35W 350mA
026.185	DRIVER DIM PUSH/DALI 35W 350mA
4250E-30152	LED 13W-700mA-1300lm-3000°K-CRI90-60°
4250E-27152	LED 13W-700mA-1250lm-2700°K-CRI90-60°
4250E-40152	LED 13W-700mA-1350lm-4000°K-CRI90-60°
4250E-30155	LED 13W-700mA-1300lm-3000°K-CRI90-30°
4250E-27155	LED 13W-700mA-1250lm-2700°K-CRI90-30°
4250E-40155	LED 13W-700mA-1350lm-4000°K-CRI90-30°
026.255	DRIVER ON/OFF min11.9W max18.2W 700mA
026.256	DRIVER ON/OFF min24.9W max35.7W 700mA
026.219	DRIVER DIM PUSH/0-10V/DALI 19.6W 700mA
026.207	DRIVER DIM 0-10V 60.2W 700mA
026.206	DRIVER DIM PUSH/DALI 60.2W 700mA

#### ACCESSORI / ACCESSORIES

023.4010	Controcassa per muratura / Housing box for brickwork / Einbaugehäuse für Betonwand / Boîtier pour béton/briques [235x140x45mm]
099.142	Pg.415 Kit emergenza / Emergency Kit

NEW  **4250E**

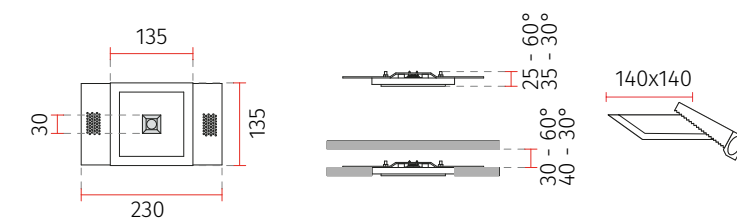



# INCASSO A PLAFONE

Ceiling recessed lighting  
Decken-Einbauleuchten  
Encastrés Plafonds

CRISTALY®

made in Italy

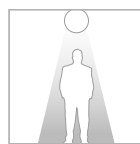

LED ispezionabile senza lavori di muratura  
LED maintenance without masonry work  
LED-Wartung ohne Mauerwerk  
Entretien des LED sans travaux de maçonnerie



PATENT PENDING

## 4251A

NEW



0,35 Kg

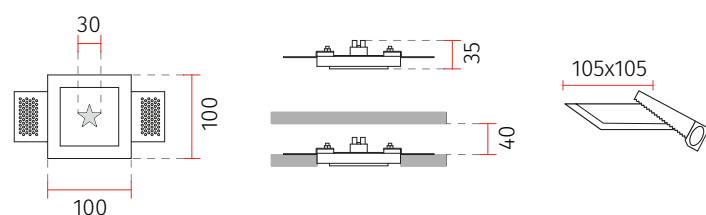

DATI TECNICI / TECHNICAL DATA	
4251A-3000	LED 2W-24Vdc-200lm-3000°K-CRI90
4251A-2700	LED 2W-24Vdc-190lm-2700°K-CRI90
4251A-4000	LED 2W-24Vdc-210lm-4000°K-CRI90
026.258	DRIVER ON/OFF 12W 24V
026.259	DRIVER ON/OFF 36W 24V
026.260	DRIVER ON/OFF 60W 24V
026.219	DRIVER DIM PUSH/0-10V/DALI 21.6W 24V
026.209	DRIVER DIM PUSH/1-10V 60W 24V

ACCESSORI / ACCESSORIES	
023.450	Controcassa per muratura / Housing box for brickwork / Einbaugeschäuse für Betonwand / Boîtier pour béton/briques [105x105x65mm]
099.142	Pg.415 Kit emergenza / Emergency Kit

Art. 4251A



NEW

## 4252A



0,35 Kg

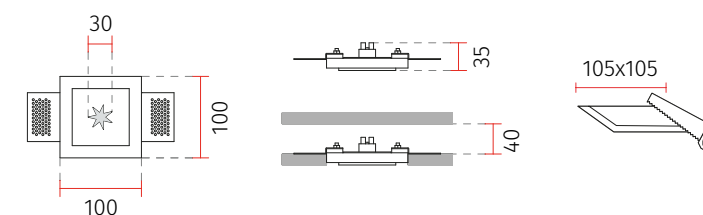

DATI TECNICI / TECHNICAL DATA	
4252A-3000	LED 2W-24Vdc-200lm-3000°K-CRI90
4252A-2700	LED 2W-24Vdc-190lm-2700°K-CRI90
4252A-4000	LED 2W-24Vdc-210lm-4000°K-CRI90
026.258	DRIVER ON/OFF 12W 24V
026.259	DRIVER ON/OFF 36W 24V
026.260	DRIVER ON/OFF 60W 24V
026.219	DRIVER DIM PUSH/0-10V/DALI 21.6W 24V
026.209	DRIVER DIM PUSH/1-10V 60W 24V

ACCESSORI / ACCESSORIES	
023.450	Controcassa per muratura / Housing box for brickwork / Einbaugeschäuse für Betonwand / Boîtier pour béton/briques [105x105x65mm]
099.142	Pg.415 Kit emergenza / Emergency Kit

Art. 4252A



IT Misure espresse in mm, tolleranza +/- 1-2 mm. L'azienda si riserva la facoltà di apportare variazioni di dati caratteristici, materiali, design, stili, tonalità, senza alcun preavviso.  
EN Measures in mm, tolerance +/- 1/2 mm. The company reserves the right to carry out variations to technical details, materials, design, style, colors with no previous notice.

DE Die Masse sind in mm, mit einer Tolleranz von +/- 1-2 mm ausgedrückt, Die Firma behält sich das Recht vor ohne Voranmeldung Änderungen an den Werkstoffen, am Design, am Stil und an der Färbung vorzunehmen.  
FR Mesures en mm, tolérance +/- 1/2 mm. La société se réserve le droit de modifier sans préavis les détails techniques, les matériaux, le design, le style et les couleurs.

# INCASSO A PLAFONE

Ceiling recessed lighting  
Decken-Einbauleuchten  
Encastrés Plafonds

CRISTALY®

made in Italy

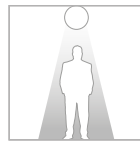

IP20 / IP44

TUNABLE WHITE Pg.412

CASAMBI Pg.408

Art. 8935C / 8935G / 8935H / 8935I - Private house - Vicenza, Italy



Diffusore in vetro  
Glass diffuser  
Glasabdeckung  
Diffuseur en verre



## DATI TECNICI / TECHNICAL DATA

8935A-3009	LED 26W-700mA-3300lm-3000°K-CRI85
8935A-2709	LED 26W-700mA-3150lm-2700°K-CRI85
8935A-4009	LED 26W-700mA-3400lm-4000°K-CRI85
026.256	DRIVER ON/OFF min24.9W max35.7W 700mA
026.207	DRIVER DIM 0-10V 60.2W 700mA
026.206	DRIVER DIM PUSH/DALI 60.2W 700mA

## ACCESSORI / ACCESSORIES

099.142	Pg.415 Kit emergenza / Emergency Kit
---------	--------------------------------------

8935A



3,45 Kg

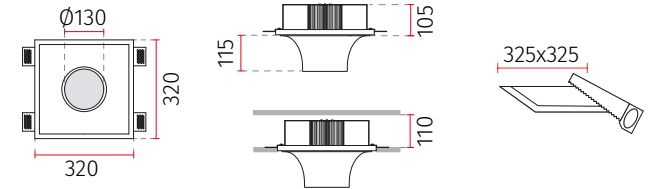

## DATI TECNICI / TECHNICAL DATA

8935B-3014	LED 52W-1400mA-6000lm-3000°K-CRI85
8935B-2714	LED 52W-1400mA-5700lm-2700°K-CRI85
8935B-4014	LED 52W-1400mA-6360lm-4000°K-CRI85
026.212	DRIVER ON/OFF min35W max60.2W 1400mA
026.207	DRIVER DIM 0-10V 58.8W 1400mA
026.206	DRIVER DIM PUSH/DALI 58.8W 1400mA

## ACCESSORI / ACCESSORIES

099.142	Pg.415 Kit emergenza / Emergency Kit
---------	--------------------------------------

Designer  
amarantostudio

8935B



12 Kg

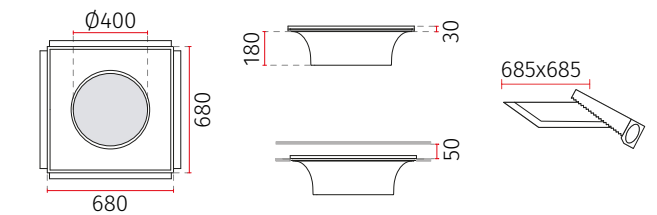

## DATI TECNICI / TECHNICAL DATA

8935C-3015	LED 88W-2x1050mA-10400lm-3000°K-CRI85
8935C-2715	LED 88W-2x1050mA-9880lm-2700°K-CRI85
8935C-4015	LED 88W-2x1050mA-11000lm-4000°K-CRI85
2x026.205	DRIVER ON/OFF min35.7W max59.9W 1050mA
2x026.207	DRIVER DIM 0-10V 59.9W 1050mA
2x026.206	DRIVER DIM PUSH/DALI 59.9W 1050mA

## ACCESSORI / ACCESSORIES

099.142	Pg.415 Kit emergenza / Emergency Kit
---------	--------------------------------------

Designer  
amarantostudio

8935C



28,5 Kg

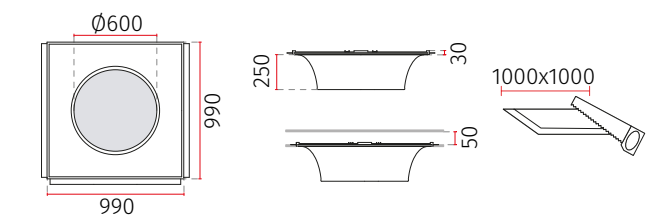

IT Misure espresse in mm, tolleranza +/- 1-2 mm. L'azienda si riserva la facoltà di apportare variazioni di dati caratteristici, materiali, design, stili, tonalità, senza alcun preavviso.  
EN Measures in mm, tolerance +/- 1/2 mm. The company reserves the right to carry out variations to technical details, materials, design, style, colors with no previous notice.

DE Die Masse sind in mm, mit einer Tolleranz von +/- 1-2 mm ausgedrückt, Die Firma behält sich das Recht vor ohne Voranmeldung Änderungen an den Werkstoffen, am Design, am Stil und an der Färbung vorzunehmen.  
FR Mesures en mm, tolérance +/- 1/2 mm. La société se réserve le droit de modifier sans préavis les détails techniques, les matériaux, le design, le style et les couleurs.



# INCASSO A PLAFONE

## Ceiling recessed lighting

### Decken-Einbauleuchten

### Encastrés Plafonds

CRISTALY®

made in Italy

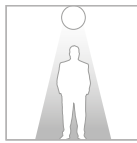

IP20

CASAMBI Pg.408

Art. 8935D / 8935G / 4110 - Thermalressort Köck, Bad Füssing – Germany  
Architekturbüro arCH-de.com, Roththalmünster



#### DATI TECNICI / TECHNICAL DATA

8935D-35	GU10 Ø111 MAX 20W-240V
8935D-92	G53 (QR111) MAX 20W-12V
8935D-3008	LED 13W-700mA-1600lm-3000° K-CRI90
8935D-2708	LED 13W-700mA-1500lm-2700° K-CRI90
8935D-4008	LED 13W-700mA-1700lm-4000° K-CRI90
026.255	DRIVER ON/OFF min11.9W max18.2W 700mA
026.256	DRIVER ON/OFF min24.9W max35.7W 700mA
026.219	DRIVER DIM PUSH/0-10V/DALI 19.6W 700mA
026.207	DRIVER DIM 0-10V 60.2W 700mA
026.206	DRIVER DIM PUSH/DALI 60.2W 700mA

#### ACCESSORI / ACCESSORIES

099.142	Pg.415 Kit emergenza / Emergency Kit
---------	--------------------------------------

# 8935D



7,5 Kg

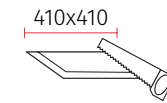
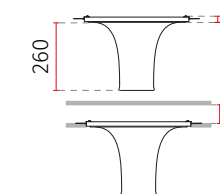
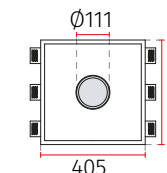

#### DATI TECNICI / TECHNICAL DATA

8935M-35	GU10 Ø111 MAX 20W-240V
8935M-92	G53 (QR111) MAX 20W-12V
8935M-3006	LED 6.5W-350mA-850lm-3000° K-CRI90
8935M-2706	LED 6.5W-350mA-800lm-2700° K-CRI90
8935M-4006	LED 6.5W-350mA-900lm-4000° K-CRI90
026.251	DRIVER ON/OFF min6W max8.8W 350mA
026.252	DRIVER ON/OFF min12.6W max18.2W 350mA
026.221	DRIVER ON/OFF min9.8W max35W 350mA
026.219	DRIVER DIM PUSH/0-10V/DALI 16.1W 350mA
026.187	DRIVER DIM 0-10V 35W 350mA
026.185	DRIVER DIM PUSH/DALI 35W 350mA
8935M-3008	LED 13W-700mA-1600lm-3000° K-CRI90
8935M-2708	LED 13W-700mA-1500lm-2700° K-CRI90
8935M-4008	LED 13W-700mA-1700lm-4000° K-CRI90
026.255	DRIVER ON/OFF min11.9W max18.2W 700mA
026.256	DRIVER ON/OFF min24.9W max35.7W 700mA
026.219	DRIVER DIM PUSH/0-10V/DALI 19.6W 700mA
026.207	DRIVER DIM 0-10V 60.2W 700mA

#### ACCESSORI / ACCESSORIES

099.142	Pg.415 Kit emergenza / Emergency Kit
---------	--------------------------------------

# 8935M



2,9 Kg

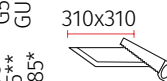
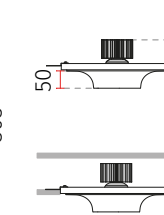
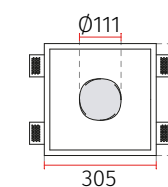

\*= altezza inclusa lampadina OSRAM GU10 H75mm e portalampada / height including OSRAM GU10 H75mm lamp and lampholder / Höhe inkl. OSRAM GU10 H75mm Lampe und Fassung / Hauteur compris ampoule OSRAM GU10 H75mm et source

\*\*= altezza inclusa lampadina OSRAM H55mm e portalampada / height including OSRAM H55mm lamp and lampholder / Höhe inkl. OSRAM H55mm Lampe und Fassung / Hauteur compris ampoule OSRAM H55mm et source

IT Misure espresse in mm, tolleranza +/- 1-2 mm. L'azienda si riserva la facoltà di apportare variazioni di dati caratteristici, materiali, design, stili, tonalità, senza alcun preavviso.  
EN Measures in mm, tolerance +/- 1/2 mm. The company reserves the right to carry out variations to technical details, materials, design, style, colors with no previous notice.

DE Die Masse sind in mm, mit einer Tolleranz von +/- 1-2 mm ausgedrückt, Die Firma behält sich das Recht vor ohne Voranmeldung Änderungen an den Werkstoffen, am Design, am Stil und an der Färbung vorzunehmen.  
FR Mesures en mm, tolérance +/- 1/2 mm. La société se réserve le droit de modifier sans préavis les détails techniques, les matériaux, le design, le style et les couleurs.

# INCASSO A PLAFONE

Ceiling recessed lighting  
Decken-Einbauleuchten  
Encastrés Plafonds

Art. 8935G - 8935H - 8935I



CRISTALY® made in Italy

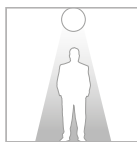

## DATI TECNICI / TECHNICAL DATA

8935H-35 GU10 Ø50 MAX 10W-240V

## ACCESSORI / ACCESSORIES

023.470	Controcassa per muratura / Housing box for brickwork / Einbaugehäuse für Betonwand / Boîtier pour béton/briques [247x247x50mm]
L001-3018	LED 8W-220-240V-650lm-3000°K-CRI85-60°
L002-3020	LED 12W-220-240V-1000lm-3000°K-CRI85-60°
L004-3018	LED 8W-220-240V-650lm-3000°K-CRI85-30°
L005-3020	LED 12W-220-240V-1000lm-3000°K-CRI85-30°
021.231	Portalampada / Lampholder / Lampenfassung / Source GU5.3

# 8935H



1,55 Kg

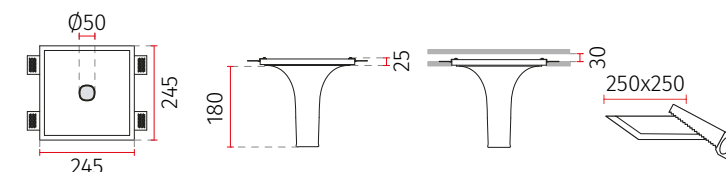

## DATI TECNICI / TECHNICAL DATA

8935I-35 GU10 Ø50 MAX 10W-240V

## ACCESSORI / ACCESSORIES

023.462	Controcassa per muratura / Housing box for brickwork / Einbaugehäuse für Betonwand / Boîtier pour béton/briques [310x310x50mm]
L001-3018	LED 8W-220-240V-650lm-3000°K-CRI85-60°
L002-3020	LED 12W-220-240V-1000lm-3000°K-CRI85-60°
L004-3018	LED 8W-220-240V-650lm-3000°K-CRI85-30°
L005-3020	LED 12W-220-240V-1000lm-3000°K-CRI85-30°
021.231	Portalampada / Lampholder / Lampenfassung / Source GU5.3

# 8935I



2,7 Kg

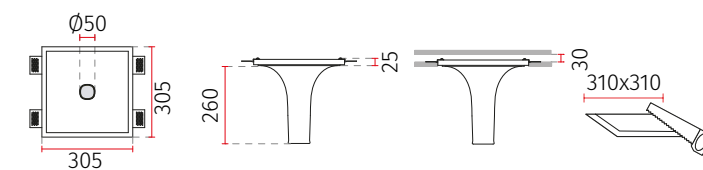

## DATI TECNICI / TECHNICAL DATA

8935L-35 GU10 Ø50 MAX 10W-240V

## ACCESSORI / ACCESSORIES

023.447	Controcassa per muratura / Housing box for brickwork / Einbaugehäuse für Betonwand / Boîtier pour béton/briques [200x200x120mm]
L001-3018	LED 8W-220-240V-650lm-3000°K-CRI85-60°
L002-3020	LED 12W-220-240V-1000lm-3000°K-CRI85-60°
L004-3018	LED 8W-220-240V-650lm-3000°K-CRI85-30°
L005-3020	LED 12W-220-240V-1000lm-3000°K-CRI85-30°
021.231	Portalampada / Lampholder / Lampenfassung / Source GU5.3

# 8935L



1,2 Kg

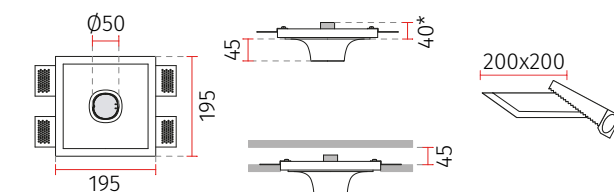

\*= Altezza inclusa lampadina OSRAM GU10 H52mm e portalampada / Height including OSRAM GU10 H52mm lamp and lampholder / Höhe inkl. OSRAM GU10 H52 mm Lampe und Fassung / Hauteur compris ampoule OSRAM GU10 H52 mm et source

DE Die Masse sind in mm, mit einer Tolleranz von +/- 1-2 mm ausgedrückt, Die Firma behält sich das Recht vor ohne Voranmeldung Änderungen an den Werkstoffen, am Design, am Stil und an der Färbung vorzunehmen.  
FR Mesures en mm, tolérance +/- 1/2 mm. La société se réserve le droit de modifier sans préavis les détails techniques, les matériaux, le design, le style et les couleurs.

## DATI TECNICI / TECHNICAL DATA

8935G-35 GU10 Ø50 MAX 10W-240V

## ACCESSORI / ACCESSORIES

023.470	Controcassa per muratura / Housing box for brickwork / Einbaugehäuse für Betonwand / Boîtier pour béton/briques [247x247x50mm]
L001-3018	LED 8W-220-240V-650lm-3000°K-CRI85-60°
L002-3020	LED 12W-220-240V-1000lm-3000°K-CRI85-60°
L004-3018	LED 8W-220-240V-650lm-3000°K-CRI85-30°
L005-3020	LED 12W-220-240V-1000lm-3000°K-CRI85-30°
021.231	Portalampada / Lampholder / Lampenfassung / Source GU5.3

# 8935G



1,65 Kg

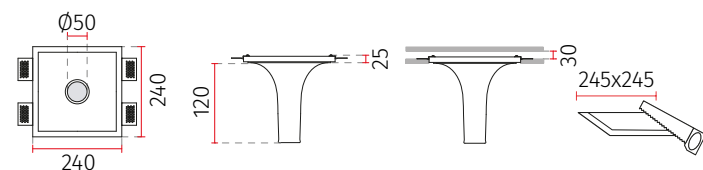

IT Misure espresse in mm, tolleranza +/- 1-2 mm. L'azienda si riserva la facoltà di apportare variazioni di dati caratteristici, materiali, design, stili, tonalità, senza alcun preavviso.  
EN Measures in mm, tolerance +/- 1/2 mm. The company reserves the right to carry out variations to technical details, materials, design, style, colors with no previous notice.

# INCASSO A PLAFONE

Ceiling recessed lighting  
Decken-Einbauleuchten  
Encastrés Plafonds

CRISTALY®

made in Italy



TUNABLE WHITE Pg.412 | CASAMBI Pg.408

Art. 8936B - Office - Prato, Italy



Diffusore in vetro  
Glass diffuser  
Glasabdeckung  
Diffuseur en verre



## DATI TECNICI / TECHNICAL DATA

8936A-3013	LED 30W-700mA-3500lm-3000°K-CRI85
8936A-2713	LED 30W-700mA-3300lm-2700°K-CRI85
8936A-4013	LED 30W-700mA-3700lm-4000°K-CRI85
026.256	DRIVER ON/OFF min24.9W max35.7W 700mA
026.207	DRIVER DIM 0-10V 60.2W 700mA
026.206	DRIVER DIM PUSH/DALI 60.2W 700mA

## ACCESSORI / ACCESSORIES

099.142	Pg.415 Kit emergenza / Emergency Kit
---------	--------------------------------------

SECTION INDEX  
GENERAL INDEX

# 8936A

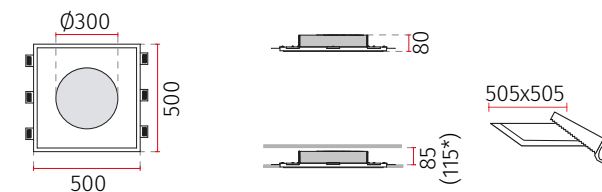

\*= Misura con alimentatore in controsoffitto / Measure with driver in counterceiling / Abmessung mit Betriebsgerät in der Zwischendecke / Mesure avec alimentation en contre-plafond

## DATI TECNICI / TECHNICAL DATA

8936B-3014	LED 52W-1400mA-6000lm-3000°K-CRI85
8936B-2714	LED 52W-1400mA-5700lm-2700°K-CRI85
8936B-4014	LED 52W-1400mA-6360lm-4000°K-CRI85
026.212	DRIVER ON/OFF min35W max60.2W 1400mA
026.207	DRIVER DIM 0-10V 58.8W 1400mA
026.206	DRIVER DIM PUSH/DALI 58.8W 1400mA

## ACCESSORI / ACCESSORIES

099.142	Pg.415 Kit emergenza / Emergency Kit
---------	--------------------------------------

SECTION INDEX  
GENERAL INDEX

# 8936B

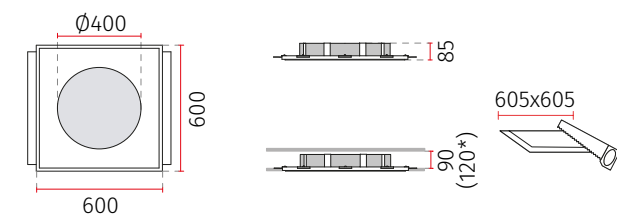

\*= Misura con alimentatore in controsoffitto / Measure with driver in counterceiling / Abmessung mit Betriebsgerät in der Zwischendecke / Mesure avec alimentation en contre-plafond

IT Misure espresse in mm, tolleranza +/- 1-2 mm. L'azienda si riserva la facoltà di apportare variazioni di dati caratteristici, materiali, design, stili, tonalità, senza alcun preavviso.  
EN Measures in mm, tolerance +/- 1/2 mm. The company reserves the right to carry out variations to technical details, materials, design, style, colors with no previous notice.

DE Die Masse sind in mm, mit einer Tolleranz von +/- 1-2 mm ausgedrückt, Die Firma behält sich das Recht vor ohne Voranmeldung Änderungen an den Werkstoffen, am Design, am Stil und an der Färbung vorzunehmen.  
FR Mesures en mm, tolérance +/- 1/2 mm. La société se réserve le droit de modifier sans préavis les détails techniques, les matériaux, le design, le style et les couleurs.

# INCASSO A PLAFONE

Ceiling recessed lighting  
Decken-Einbauleuchten  
Encastrés Plafonds

CRISTALY®

made in Italy

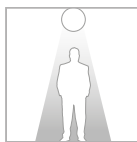

TUNABLE WHITE Pg.412 | CASAMBI Pg.408

Art. 8917 / 8935H / 4190 - Shop - Ventimiglia - Italy



DATI TECNICI / TECHNICAL DATA	
8937A-3028	LED 25W-700mA-3550lm-3000°K-CRI85
8937A-2728	LED 25W-700mA-3370lm-2700°K-CRI85
8937A-4028	LED 25W-700mA-3760lm-4000°K-CRI85
026.256	DRIVER ON/OFF min24.9W max35.7W 700mA
026.207	DRIVER DIM 0-10V 60.2W 700mA
026.206	DRIVER DIM PUSH/DALI 60.2W 700mA

  

ACCESSORI / ACCESSORIES	
099.142	Pg.415 Kit emergenza / Emergency Kit

## 8937A



6,5 Kg

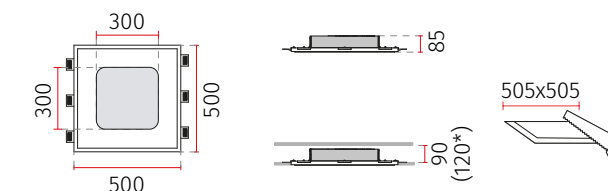

\*= Misura con alimentatore in controsoffitto / Measure with driver in counterceiling / Abmessung mit Betriebsgerät in der Zwischendecke / Mesure avec alimentation en contre-plafond

Diffusore in vetro  
Glass diffuser  
Glasabdeckung  
Diffuseur en verre



DATI TECNICI / TECHNICAL DATA	
8937B-3029	LED 51W-1050mA-7100lm-3000°K-CRI85
8937B-2729	LED 51W-1050mA-6740lm-2700°K-CRI85
8937B-4029	LED 51W-1050mA-7500lm-4000°K-CRI85
026.205	DRIVER ON/OFF min35.7W max59.9W 1050mA
026.207	DRIVER DIM 0-10V 59.9W 1050mA
026.206	DRIVER DIM PUSH/DALI 59.9W 1050mA

  

ACCESSORI / ACCESSORIES	
099.142	Pg.415 Kit emergenza / Emergency Kit

## 8937B



9,5 Kg

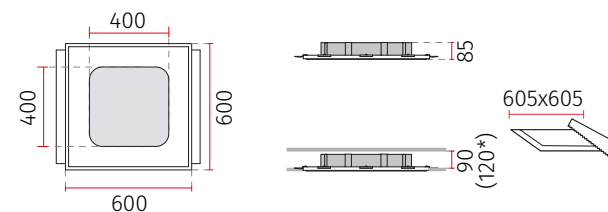

\*= Misura con alimentatore in controsoffitto / Measure with driver in counterceiling / Abmessung mit Betriebsgerät in der Zwischendecke / Mesure avec alimentation en contre-plafond

Diffusore in vetro  
Glass diffuser  
Glasabdeckung  
Diffuseur en verre



## 8917



6,2 Kg

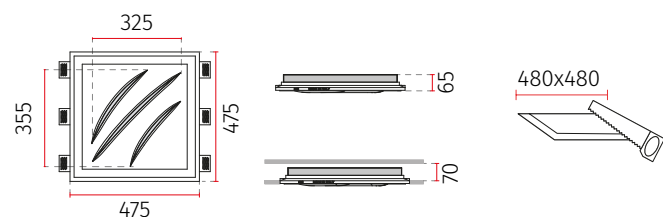

DATI TECNICI / TECHNICAL DATA	
8917-3005	LED 28.5W-24Vdc-2550lm-3000°K-CRI85
8917-2705	LED 28.5W-24Vdc-2400lm-2700°K-CRI85
8917-4005	LED 28.5W-24Vdc-2700lm-4000°K-CRI85
026.259	DRIVER ON/OFF 36W 24V
026.260	DRIVER ON/OFF 60W 24V
026.261	DRIVER ON/OFF 150W 24V
026.262	DRIVER ON/OFF 240W 24V
026.209	DRIVER DIM PUSH/1-10V 60W 24V
026.190+026.261	DRIVER DIM PUSH/0-10V/DALI 150W 24V
026.190+026.262	DRIVER DIM PUSH/0-10V/DALI 240W 24V

ACCESSORI / ACCESSORIES	
099.142	Pg.415 Kit emergenza / Emergency Kit





IT Misure espresse in mm, tolleranza +/- 1-2 mm. L'azienda si riserva la facoltà di apportare variazioni di dati caratteristici, materiali, design, stili, tonalità, senza alcun preavviso.  
EN Measures in mm, tolerance +/- 1/2 mm. The company reserves the right to carry out variations to technical details, materials, design, style, colors with no previous notice.

DE Die Masse sind in mm, mit einer Tolleranz von +/- 1-2 mm ausgedrückt, Die Firma behält sich das Recht vor ohne Voranmeldung Änderungen an den Werkstoffen, am Design, am Stil und an der Färbung vorzunehmen.  
FR Mesures en mm, tolérance +/- 1/2 mm. La société se réserve le droit de modifier sans préavis les détails techniques, les matériaux, le design, le style et les couleurs.

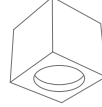
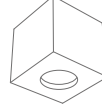
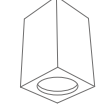

Life is short  
Break the rules  
Forgive quickly  
KISS SLOWLY  
LOVE TRULY  
Laugh frequently  
Never apologize  
With Your Soul

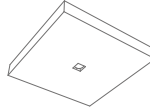
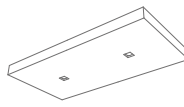
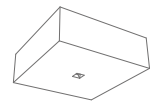
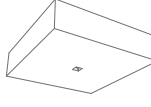
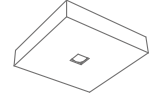
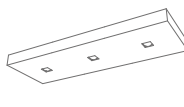
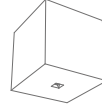
**A PLAFONE**  
 Ceiling lighting  
 Deckenleuchten  
 Plafonniers

					
5507G p.221	5507H p.221	5507I p.221	5505F p.223	8895 p.225	8897 p.227
					
8899 p.227	8909 p.227	8911 p.227	8898 p.229	8900 p.229	8910 p.229
					
8912 p.229	8903A p.231	8903B p.231	8903C p.231	<b>NEW</b> 8903E p.231	8904A p.232
					
<b>NEW</b> 8904B p.232	<b>NEW</b> 8913 p.232	8914A p.233	8914B p.233	8914C p.233	8914D p.236
					
<b>NEW</b> 8914E p.236	8914Q p.236	<b>NEW</b> 8916E p.237	8943D p.239	8943H p.239	8943N p.239
					
8943O p.239	8949A p.240	8949B p.241	8949C p.241	8952A p.242	8952B p.243
					
8952C p.243					

# A PLAFONE

## Ceiling lighting

## Deckenleuchten

## Plafonniers

CRISTALY®

made in Italy

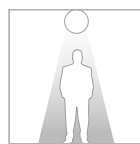

CASAMBI Pg.408

Per l'installazione è necessario uno dei seguenti accessori:

EN For the installation one of following accessories is required:  
DE Für die Installation ist eines der folgenden Zubehöre erforderlich:  
FR Pour l'installation l'un des accessoires suivants est requis:

- 5507-KIT01 (pg. 222)
- 5505F-00 (pg. 223)

Art. 5507G/4189 - Private house - Pordenone, Italy



### DATI TECNICI / TECHNICAL DATA

5507G-3039	LED 4W-350mA-350lm-3000°K-CRI85
5507G-2739	LED 4W-350mA-330lm-2700°K-CRI85
5507G-4039	LED 4W-350mA-370lm-4000°K-CRI85
026.250	DRIVER ON/OFF min2.8W max4.2W 350mA
026.251	DRIVER ON/OFF min6W max8.8W 350mA
026.236	DRIVER ON/OFF min8.8W max12W 350mA
026.252	DRIVER ON/OFF min12.6W max18.2W 350mA
026.221	DRIVER ON/OFF min9.8W max35W 350mA
026.219	DRIVER DIM PUSH/0-10V/DALI 16.1W 350mA
026.187	DRIVER DIM 0-10V 35W 350mA
026.185	DRIVER DIM PUSH/DALI 35W 350mA

### ACCESSORI / ACCESSORIES

5505F-00	Accessorio da incasso per soffitto / Recessed ceiling accessory / Einbau/Deckenzubehör / Accessoir plafond encastré
5507-KIT01	Kit attacco al soffitto con TIGE / Ceiling mounting KIT with TIGE / Decken-Montage-Kit mit TIGE / Set de Montage Plafonds avec TIGE
099.142	Pg.415 Kit emergenza / Emergency Kit



0,3 Kg



Ø16

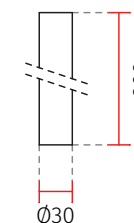

### 5507H

### DATI TECNICI / TECHNICAL DATA

5507H-3039	LED 4W-350mA-350lm-3000°K-CRI85
5507H-2739	LED 4W-350mA-330lm-2700°K-CRI85
5507H-4039	LED 4W-350mA-370lm-4000°K-CRI85
026.250	DRIVER ON/OFF min2.8W max4.2W 350mA
026.251	DRIVER ON/OFF min6W max8.8W 350mA
026.236	DRIVER ON/OFF min8.8W max12W 350mA
026.252	DRIVER ON/OFF min12.6W max18.2W 350mA
026.221	DRIVER ON/OFF min9.8W max35W 350mA
026.219	DRIVER DIM PUSH/0-10V/DALI 16.1W 350mA
026.187	DRIVER DIM 0-10V 35W 350mA
026.185	DRIVER DIM PUSH/DALI 35W 350mA

### ACCESSORI / ACCESSORIES

5505F-00	Accessorio da incasso per soffitto / Recessed ceiling accessory / Einbau/Deckenzubehör / Accessoir plafond encastré
5507-KIT01	Kit attacco al soffitto con TIGE / Ceiling mounting KIT with TIGE / Decken-Montage-Kit mit TIGE / Set de Montage Plafonds avec TIGE
099.142	Pg.415 Kit emergenza / Emergency Kit



0,5 Kg



Ø16

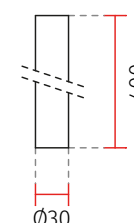

### 5507I

### DATI TECNICI / TECHNICAL DATA

5507I-3039	LED 4W-350mA-350lm-3000°K-CRI85
5507I-2739	LED 4W-350mA-330lm-2700°K-CRI85
5507I-4039	LED 4W-350mA-370lm-4000°K-CRI85
026.250	DRIVER ON/OFF min2.8W max4.2W 350mA
026.251	DRIVER ON/OFF min6W max8.8W 350mA
026.236	DRIVER ON/OFF min8.8W max12W 350mA
026.252	DRIVER ON/OFF min12.6W max18.2W 350mA
026.221	DRIVER ON/OFF min9.8W max35W 350mA
026.219	DRIVER DIM PUSH/0-10V/DALI 16.1W 350mA
026.187	DRIVER DIM 0-10V 35W 350mA
026.185	DRIVER DIM PUSH/DALI 35W 350mA

### ACCESSORI / ACCESSORIES

5505F-00	Accessorio da incasso per soffitto / Recessed ceiling accessory / Einbau/Deckenzubehör / Accessoir plafond encastré
5507-KIT01	Kit attacco al soffitto con TIGE / Ceiling mounting KIT with TIGE / Decken-Montage-Kit mit TIGE / Set de Montage Plafonds avec TIGE
099.142	Pg.415 Kit emergenza / Emergency Kit



0,7 Kg



Ø16

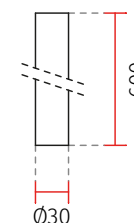

IT Misure espresse in mm, tolleranza +/- 1-2 mm. L'azienda si riserva la facoltà di apportare variazioni di dati caratteristici, materiali, design, stili, tonalità, senza alcun preavviso.  
EN Measures in mm, tolerance +/- 1/2 mm. The company reserves the right to carry out variations to technical details, materials, design, style, colors with no previous notice.

DE Die Masse sind in mm, mit einer Tolleranz von +/- 1-2 mm ausgedrückt. Die Firma behält sich das Recht vor ohne Voranmeldung Änderungen an den Werkstoffen, am Design, am Stil und an der Färbung vorzunehmen.  
FR Mesures en mm, tolérance +/- 1/2 mm. La société se réserve le droit de modifier sans préavis les détails techniques, les matériaux, le design, le style et les couleurs.

# ACCESSORI

Accessories  
Zubehöre  
Accessoires

made in Italy

L'installazione degli articoli 5507G - 5507H - 5507I prevede l'utilizzo di uno dei seguenti accessori, a seconda che il controsoffitto sia esistente o in fase di realizzazione:

EN For the installation of the articles 5507G - 5507H - 5507I it is required the use of one of the following accessories, whether the false ceiling is already existing or it is in progress:

DE Für die Installation der Artikel 5507G - 5507H - 5507I ist eines der folgenden Zubehörteile notwendig je nachdem, ob die Zwischendecke vorhanden ist oder sich im Bau befindet:

FR Pour l'installation des articles 5507G - 5507H - 5507I, l'un des accessoires suivants est nécessaire dans les conditions que le faux plafond soit existant ou bien en phase de construction:

- 5507-KIT01
- 5505F-00

Controsoffitto in fase di realizzazione: / Ceiling under construction: /  
Im Bau Zwischendecke: / Plafond en construction:

## DATI TECNICI / TECHNICAL DATA

5507-KIT01 Kit attacco al soffitto con TIGE  
Ceiling mounting KIT with TIGE

# 5507-KIT01



L'accessorio 5507-KIT01 permette l'installazione in lastra di cartongesso ancora da posizionare a soffitto. Dopo aver forato il cartongesso e inserito il 5507-KIT01, che permette il passaggio dei cavi elettrici, la lastra è pronta per essere posizionata e installata.

EN The 5507-KIT01 accessory allows the installation into a plasterboard before fixing it on the ceiling. After having cut the plasterboard and inserted the 5507-KIT01, which allows to run the electrical cables, the plasterboard is ready to be positioned and installed.

DE Das Zubehör 5507-KIT01 ermöglicht den Einbau in die noch im Bau Gipskartondecke. Nach dem Bohren der Gipskartondecke, dem Einsetzen des 5507-KIT01 dem Verlegen der Kabel, kann die Platte positioniert und installiert werden.

FR L'accessoire 5507-KIT01 permet l'installation dans les faux plafonds. Après avoir coupé la plaque de plâtre et inséré le 5507-KIT01, cela permet le passage des câbles électriques, la plaque de plâtre est prête à être positionnée et installée.

1. Forare  
Drill  
Bohren  
Forer
  2. Inserire Tige  
Insert the ceiling steel stem  
Deckenstiel einsetzen  
Insérer la Tige
  3. Inserire cavi  
Run cables  
Kabel verlegen  
Insérer les câbles
  4. Stuccare  
Finish  
Verputzen  
Enduire
  5. Fissare plafoniera  
Fix ceiling lamp  
Deckenleuchte fixieren  
Fixer le plafonnier
- 

IT Misure espresse in mm, tolleranza +/- 1-2 mm. L'azienda si riserva la facoltà di apportare variazioni di dati caratteristici, materiali, design, stili, tonalità, senza alcun preavviso.  
EN Measures in mm, tolerance +/- 1/2 mm. The company reserves the right to carry out variations to technical details, materials, design, style, colors with no previous notice.

Controsoffitto esistente: / Existing false ceiling: /  
Vorhandene Zwischendecke: / Contre plafond existant:

CRISTALY®



## DATI TECNICI / TECHNICAL DATA

5505F-00 Accessorio da incasso per soffitto / Recessed ceiling accessory /  
Einbau/Deckenzubehör / Accessoir plafond encastré

## ACCESSORI / ACCESSORIES

023.450 Controcassa per muratura / Housing box for brickwork / Einbau-  
gehäuse für Betonwand / Boîtier pour béton/briques [105x105x65mm]

# 5505F



0,8 Kg

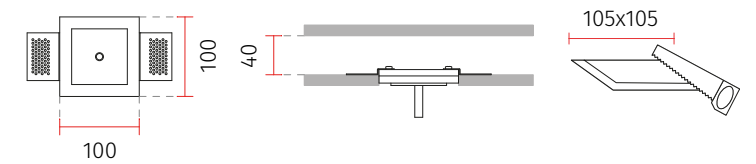

L'accessorio 5505F permette l'installazione degli articoli 5507G - 5507H - 5507I in soffitti in cartongesso già terminati, attraverso un sistema ad incasso. Tramite l'apposita controcassa è inoltre possibile effettuare l'installazione anche in soffitti in muratura.

EN The 5505F accessory allows installation of articles 5507G - 5507H - 5507I in existing plasterboard ceilings thanks to a recessed system. It is also possible to install it in concrete or brickwork ceilings using a special housing box.

DE Das Zubehör 5505F ermöglicht den Einbau von 5507G - 5507H - 5507I in Gipskartondecken, die bereits fertiggestellt sind. Die Montage der Einbaugehäuse erlaubt es, diese Elemente in Betonwand oder Mauer zu installieren.

FR L'accessoire 5505F permet l'installation des articles 5507G - 5507H - 5507I dans des faux plafonds existants. Le système de boîtier encastré permet l'installation de cet accessoire même dans des murs en béton ou briques

1. Tagliare  
Cut  
Schneiden  
Couper
  2. Inserire cavi  
Run cables  
Kabel verlegen  
Insérer les câbles
  3. Posizionare articolo  
Insert the article  
Artikel einsetzen  
Insérer l'article
  4. Stuccare  
Finish  
Verputzen  
Enduire
  5. Fissare plafoniera  
Fix ceiling lamp  
Deckenleuchte fixieren  
Fixer le plafonnier
- 

DE Die Masse sind in mm, mit einer Tolleranz von +/- 1-2 mm ausgedrückt, Die Firma behält sich das Recht vor ohne Voranmeldung Änderungen an den Werkstoffen, am Design, am Stil und an der Färbung vorzunehmen.  
FR Mesures en mm, tolérance +/- 1/2 mm. La société se réserve le droit de modifier sans préavis les détails techniques, les matériaux, le design, le style et les couleurs.



**A PLAFONE**  
Ceiling lighting  
Deckenleuchten  
Plafonniers

CRISTALY®

made in Italy

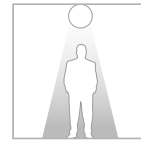

CASAMBI Pg.408

FINITURE SU RICHIESTA / FINISHES ON DEMAND  
OBERFLÄCHENVERARBEITUNGEN AUF NACHFRAGE / FINITIONS SUR DEMANDE:



390  
CORTEN



391  
OSSIDO  
OXIDE

DATI TECNICI / TECHNICAL DATA

8895-94

GU4 Ø35 MAX 5W-12V



8895



0,15 Kg

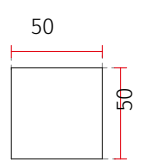
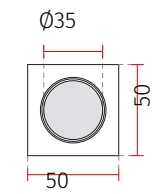

Art. 8895 - Private house - Hallstatt - Austria



IT Misure espresse in mm, tolleranza +/- 1-2 mm. L'azienda si riserva la facoltà di apportare variazioni di dati caratteristici, materiali, design, stili, tonalità, senza alcun preavviso.  
EN Measures in mm, tolerance +/- 1/2 mm. The company reserves the right to carry out variations to technical details, materials, design, style, colors with no previous notice.

DE Die Masse sind in mm, mit einer Tolleranz von +/- 1-2 mm ausgedrückt, Die Firma behält sich das Recht vor ohne Voranmeldung Änderungen an den Werkstoffen, am Design, am Stil und an der Färbung vorzunehmen.  
FR Mesures en mm, tolérance +/- 1/2 mm. La société se réserve le droit de modifier sans préavis les détails techniques, les matériaux, le design, le style et les couleurs.

**A PLAFONE**  
Ceiling lighting  
Deckenleuchten  
Plafonniers

CRISTALY®

made in Italy

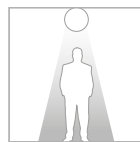

FINITURE SU RICHIESTA / FINISHES ON DEMAND  
OBERFLÄCHENVERARBEITUNGEN AUF NACHFRAGE / FINITIONS SUR DEMANDE:

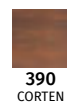

390  
CORTEN

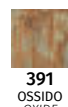

391  
OSSIDO  
OXIDE

Art. 8897 - Private house - Bari, Italy  
Arch. Paolo Tari e Gianpiero Conserva

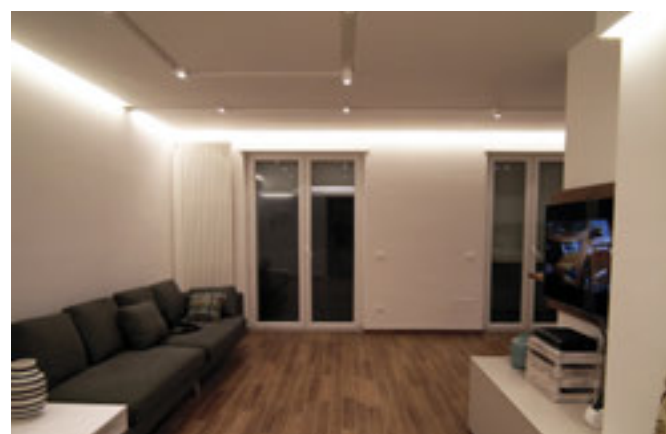

DATI TECNICI / TECHNICAL DATA

8897-35 GU10 Ø50 MAX 10W-240V

ACCESSORI / ACCESSORIES

021.231 Portalampada / Lampholder / Fassung / Douille: GU5.3

8897



0,4 Kg

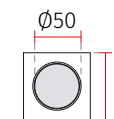
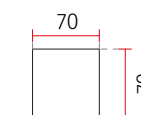

DATI TECNICI / TECHNICAL DATA

8899-35 GU10 Ø50 MAX 10W-240V

ACCESSORI / ACCESSORIES

021.231 Portalampada / Lampholder / Fassung / Douille: GU5.3

8899



0,5 Kg

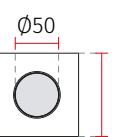
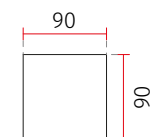

DATI TECNICI / TECHNICAL DATA

8909-35 GU10 Ø50 MAX 10W-240V

ACCESSORI / ACCESSORIES

021.231 Portalampada / Lampholder / Fassung / Douille: GU5.3

8909



0,65 Kg

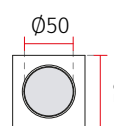
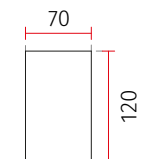

DATI TECNICI / TECHNICAL DATA

8911-35 GU10 Ø50 MAX 10W-240V

ACCESSORI / ACCESSORIES

021.231 Portalampada / Lampholder / Fassung / Douille: GU5.3

8911



1,05 Kg

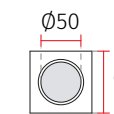
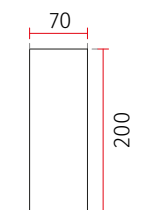

IT Misure espresse in mm, tolleranza +/- 1-2 mm. L'azienda si riserva la facoltà di apportare variazioni di dati caratteristici, materiali, design, stili, tonalità, senza alcun preavviso.  
EN Measures in mm, tolerance +/- 1/2 mm. The company reserves the right to carry out variations to technical details, materials, design, style, colors with no previous notice.

DE Die Masse sind in mm, mit einer Tolleranz von +/- 1-2 mm ausgedrückt, Die Firma behält sich das Recht vor ohne Voranmeldung Änderungen an den Werkstoffen, am Design, am Stil und an der Färbung vorzunehmen.  
FR Mesures en mm, tolérance +/- 1/2 mm. La société se réserve le droit de modifier sans préavis les détails techniques, les matériaux, le design, le style et les couleurs.

**A PLAFONE**  
Ceiling lighting  
Deckenleuchten  
Plafonniers

CRISTALY<sup>®</sup> made in Italy

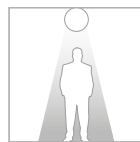

**8898**

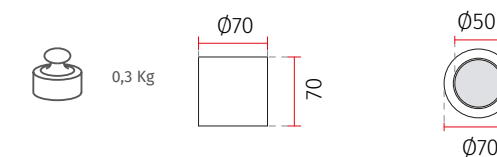

DATI TECNICI / TECHNICAL DATA	
8898-35	GU10 Ø50 MAX 10W-240V
ACCESSORI / ACCESSORIES	
021.231	Portalampada / Lampholder / Fassung / Douille: GU5.3

Art. 8900 - Restaurant - Brest, France



**8900**

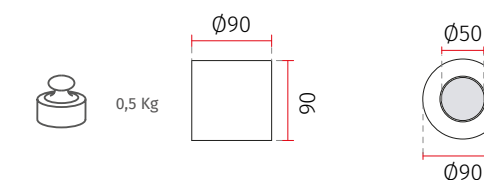

DATI TECNICI / TECHNICAL DATA	
8900-35	GU10 Ø50 MAX 10W-240V
ACCESSORI / ACCESSORIES	
021.231	Portalampada / Lampholder / Fassung / Douille: GU5.3

**8910**

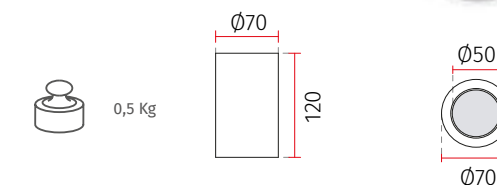

DATI TECNICI / TECHNICAL DATA	
8910-35	GU10 Ø50 MAX 10W-240V
ACCESSORI / ACCESSORIES	
021.231	Portalampada / Lampholder / Fassung / Douille: GU5.3

**8912**

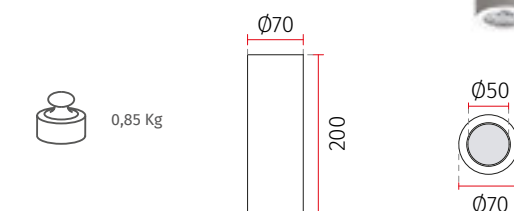

DATI TECNICI / TECHNICAL DATA	
8912-35	GU10 Ø50 MAX 10W-240V
ACCESSORI / ACCESSORIES	
021.231	Portalampada / Lampholder / Fassung / Douille: GU5.3

IT Misure espresse in mm, tolleranza +/- 1-2 mm. L'azienda si riserva la facoltà di apportare variazioni di dati caratteristici, materiali, design, stili, tonalità, senza alcun preavviso.  
EN Measures in mm, tolerance +/- 1/2 mm. The company reserves the right to carry out variations to technical details, materials, design, style, colors with no previous notice.

DE Die Masse sind in mm, mit einer Tolleranz von +/- 1-2 mm ausgedrückt, Die Firma behält sich das Recht vor ohne Voranmeldung Änderungen an den Werkstoffen, am Design, am Stil und an der Färbung vorzunehmen.  
FR Mesures en mm, tolérance +/- 1/2 mm. La société se réserve le droit de modifier sans préavis les détails techniques, les matériaux, le design, le style et les couleurs.

**A PLAFONE**  
Ceiling lighting  
Deckenleuchten  
Plafonniers

CRISTALY®

made in Italy

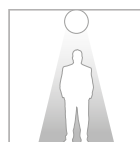

CASAMBI Pg.408

Art. 8903

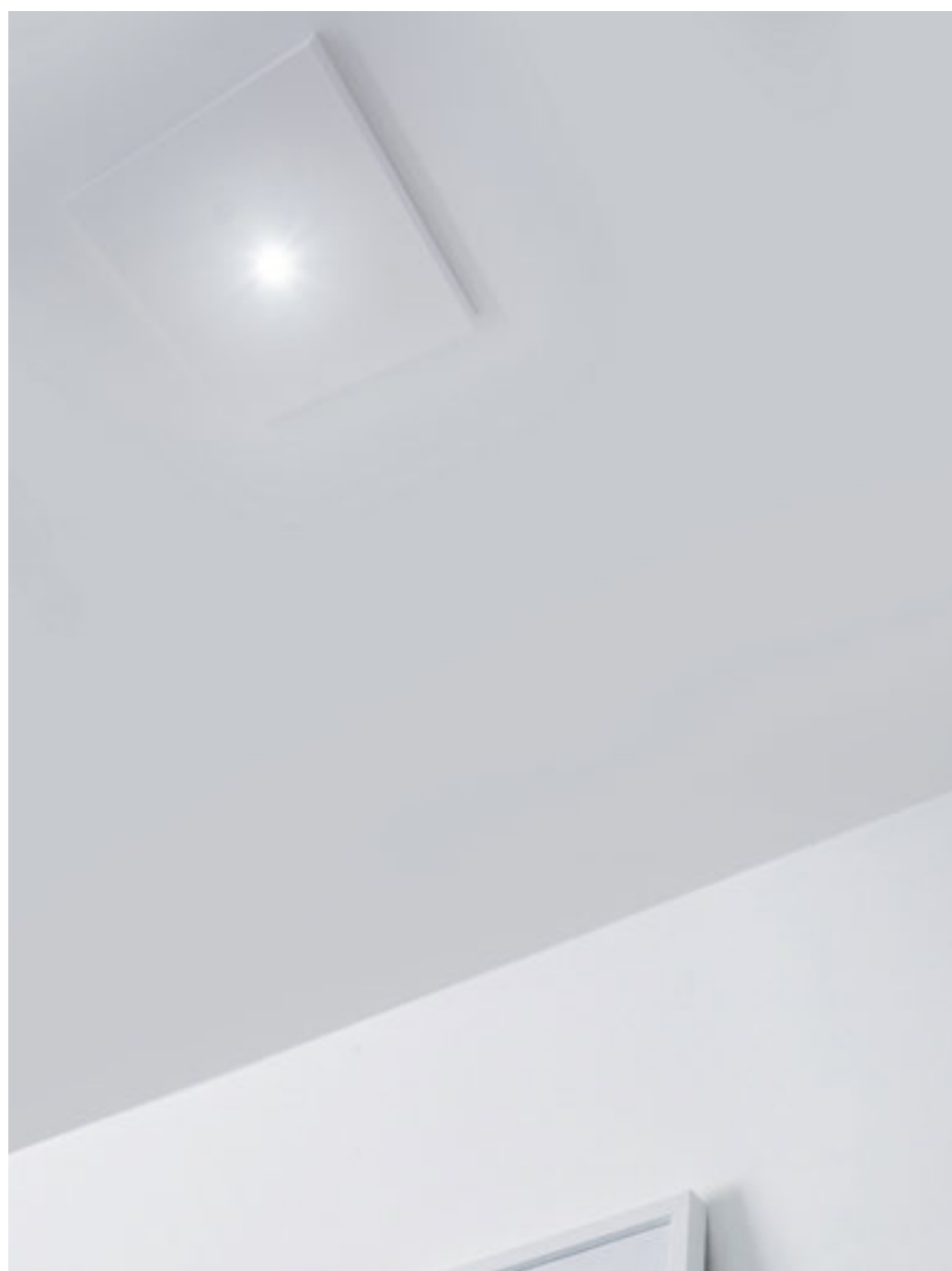

Nuova lente LED  
New Led lense  
Neue LED-Linse  
Nouvelle lentille LED

**DATI TECNICI / TECHNICAL DATA**

8903A-3040	LED 6W-500mA-500lm-3000°K-CRI85
8903A-2740	LED 6W-500mA-475lm-2700°K-CRI85
8903A-4040	LED 6W-500mA-525lm-4000°K-CRI85
026.238	DRIVER ON/OFF min5.5W max9W 500mA
026.237	DRIVER ON/OFF min11W max18W 500mA
026.254	DRIVER ON/OFF min16.5W max23.5W 500mA
026.219	DRIVER DIM PUSH/0-10V/DALI 20W 500mA
026.207	DRIVER DIM 0-10V 45W 500mA
026.206	DRIVER DIM PUSH/DALI 45W 500mA

**ACCESSORI / ACCESSORIES**

099.142	Pg.415 Kit emergenza / Emergency Kit
---------	--------------------------------------



0,65 Kg

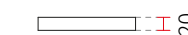
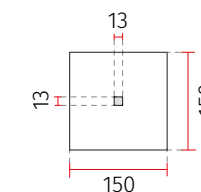

**8903A**



**DATI TECNICI / TECHNICAL DATA**

8903B-3040	LED 2x6W-500mA-1000lm-3000°K-CRI85
8903B-2740	LED 2x6W-500mA-950lm-2700°K-CRI85
8903B-4040	LED 2x6W-500mA-1050lm-4000°K-CRI85
026.237	DRIVER ON/OFF min11W max18W 500mA
026.219	DRIVER DIM PUSH/0-10V/DALI 20W 500mA
026.207	DRIVER DIM 0-10V 45W 500mA
026.206	DRIVER DIM PUSH/DALI 45W 500mA

**ACCESSORI / ACCESSORIES**

099.142	Pg.415 Kit emergenza / Emergency Kit
---------	--------------------------------------



1,3 Kg

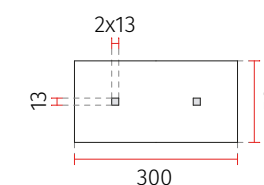

**8903B**



**DATI TECNICI / TECHNICAL DATA**

8903C-3040	LED 3x6W-500mA-1500lm-3000°K-CRI85
8903C-2740	LED 3x6W-500mA-1425lm-2700°K-CRI85
8903C-4040	LED 3x6W-500mA-1575lm-4000°K-CRI85
026.254	DRIVER ON/OFF min16.5W max23.5W 500mA
026.219	DRIVER DIM PUSH/0-10V/DALI 20W 500mA
026.207	DRIVER DIM 0-10V 45W 500mA
026.206	DRIVER DIM PUSH/DALI 45W 500mA

**ACCESSORI / ACCESSORIES**

099.142	Pg.415 Kit emergenza / Emergency Kit
---------	--------------------------------------



1,8Kg

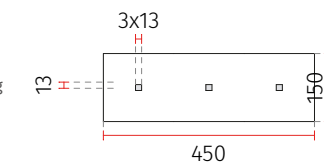

**8903C**



**DATI TECNICI / TECHNICAL DATA**

8903E-30130	LED 6W-220-240V-500lm-3000°K-CRI85
8903E-27130	LED 6W-220-240V-475lm-2700°K-CRI85
8903E-40130	LED 6W-220-240V-525lm-4000°K-CRI85



1,05 Kg

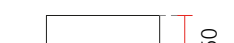
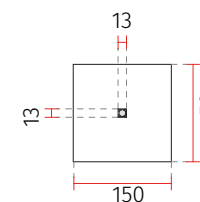

**NEW 8903E**



IT Misure espresse in mm, tolleranza +/- 1-2 mm. L'azienda si riserva la facoltà di apportare variazioni di dati caratteristici, materiali, design, stili, tonalità, senza alcun preavviso.  
EN Measures in mm, tollerance +/- 1/2 mm. The company reserves the right to carry out variations to technical details, materials, design, style, colors with no previous notice.

DE Die Masse sind in mm, mit einer Tolleranz von +/- 1-2 mm ausgedrückt, Die Firma behält sich das Recht vor ohne Voranmeldung Änderungen an den Werkstoffen, am Design, am Stil und an der Färbung vorzunehmen.  
FR Mesures en mm, tolérance +/- 1/2 mm. La société se réserve le droit de modifier sans préavis les détails techniques, les matériaux, le design, le style et les couleurs.

**A PLAFONE**  
Ceiling lighting  
Deckenleuchten  
Plafonniers

CRISTALY®

made in Italy

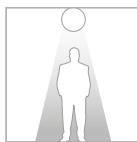

CASAMBI Pg.408



IP20

# 8904A

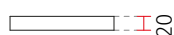
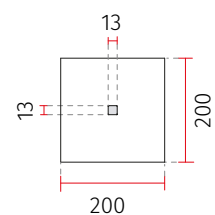

### DATI TECNICI / TECHNICAL DATA

8904A-3041	LED 11W-900mA-900lm-3000°K-CRI85
8904A-2741	LED 11W-900mA-850lm-2700°K-CRI85
8904A-4041	LED 11W-900mA-950lm-4000°K-CRI85
026.240	DRIVER ON/OFF min9W max13.5W 900mA
026.246	DRIVER ON/OFF min17.1W max24.3W 900mA
026.257	DRIVER ON/OFF min27W max36W 900mA
026.219	DRIVER DIM PUSH/0-10V/DALI 19.8W 900mA
026.207	DRIVER DIM 0-10V 60.3W 900mA
026.206	DRIVER DIM PUSH/DALI 60.3W 900mA

### ACCESSORI / ACCESSORIES

099.142	Pg.415 Kit emergenza / Emergency Kit
---------	--------------------------------------

# 8904B NEW

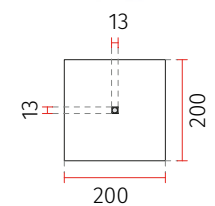

### DATI TECNICI / TECHNICAL DATA

8904B-30131	LED 9W-220-240V-750lm-3000°K-CRI85
8904B-27131	LED 9W-220-240V-700lm-2700°K-CRI85
8904B-40131	LED 9W-220-240V-800lm-4000°K-CRI85

# 8913 NEW

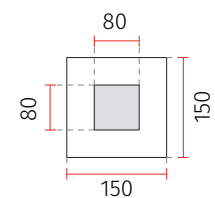

### DATI TECNICI / TECHNICAL DATA

8913-30131	LED 11W-220-240V-900lm-3000°K-CRI85
8913-27131	LED 11W-220-240V-850lm-2700°K-CRI85
8913-40131	LED 11W-220-240V-950lm-4000°K-CRI85

### DATI TECNICI / TECHNICAL DATA

8914A-3039	LED 4W-350mA-350lm-3000°K-CRI85
8914A-2739	LED 4W-350mA-330lm-2700°K-CRI85
8914A-4039	LED 4W-350mA-370lm-4000°K-CRI85
026.250	DRIVER ON/OFF min2.8W max4.2W 350mA
026.251	DRIVER ON/OFF min6W max8.8W 350mA
026.236	DRIVER ON/OFF min8.8W max12W 350mA
026.252	DRIVER ON/OFF min12.6W max18.2W 350mA
026.221	DRIVER ON/OFF min9.8W max35W 350mA
026.219	DRIVER DIM PUSH/0-10V/DALI 16.1W 350mA
026.187	DRIVER DIM 0-10V 35W 350mA
026.185	DRIVER DIM PUSH/DALI 35W 350mA

### ACCESSORI / ACCESSORIES

099.142	Pg.415 Kit emergenza / Emergency Kit
---------	--------------------------------------

### DATI TECNICI / TECHNICAL DATA

8914B-3039	LED 2x4W-350mA-700lm-3000°K-CRI85
8914B-2739	LED 2x4W-350mA-660lm-2700°K-CRI85
8914B-4039	LED 2x4W-350mA-725lm-4000°K-CRI85
026.251	DRIVER ON/OFF min6W max8.8W 350mA
026.252	DRIVER ON/OFF min12.6W max18.2W 350mA
026.221	DRIVER ON/OFF min9.8W max35W 350mA
026.219	DRIVER DIM PUSH/0-10V/DALI 16.1W 350mA
026.187	DRIVER DIM 0-10V 35W 350mA
026.185	DRIVER DIM PUSH/DALI 35W 350mA

### ACCESSORI / ACCESSORIES

099.142	Pg.415 Kit emergenza / Emergency Kit
---------	--------------------------------------

### DATI TECNICI / TECHNICAL DATA

8914C-3039	LED 3x4W-350mA-1050lm-3000°K-CRI85
8914C-2739	LED 3x4W-350mA-990lm-2700°K-CRI85
8914C-4039	LED 3x4W-350mA-1110lm-4000°K-CRI85
026.236	DRIVER ON/OFF min8.8W max12W 350mA
026.221	DRIVER ON/OFF min9.8W max35W 350mA
026.219	DRIVER DIM PUSH/0-10V/DALI 16.1W 350mA
026.187	DRIVER DIM 0-10V 35W 350mA
026.185	DRIVER DIM PUSH/DALI 35W 350mA

### ACCESSORI / ACCESSORIES

099.142	Pg.415 Kit emergenza / Emergency Kit
---------	--------------------------------------

# 8914A

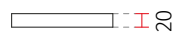
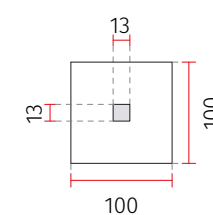

# 8914B

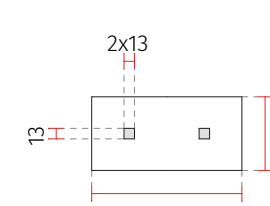

# 8914C

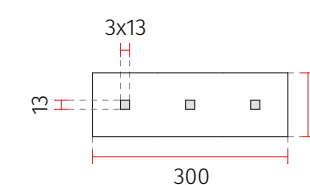

IT Misure espresse in mm, tolleranza +/- 1-2 mm. L'azienda si riserva la facoltà di apportare variazioni di dati caratteristici, materiali, design, stili, tonalità, senza alcun preavviso.  
EN Measures in mm, tolerance +/- 1/2 mm. The company reserves the right to carry out variations to technical details, materials, design, style, colors with no previous notice.

DE Die Masse sind in mm, mit einer Tolleranz von +/- 1-2 mm ausgedrückt, Die Firma behält sich das Recht vor ohne Voranmeldung Änderungen an den Werkstoffen, am Design, am Stil und an der Färbung vorzunehmen.  
FR Mesures en mm, tolérance +/- 1/2 mm. La société se réserve le droit de modifier sans préavis les détails techniques, les matériaux, le design, le style et les couleurs.

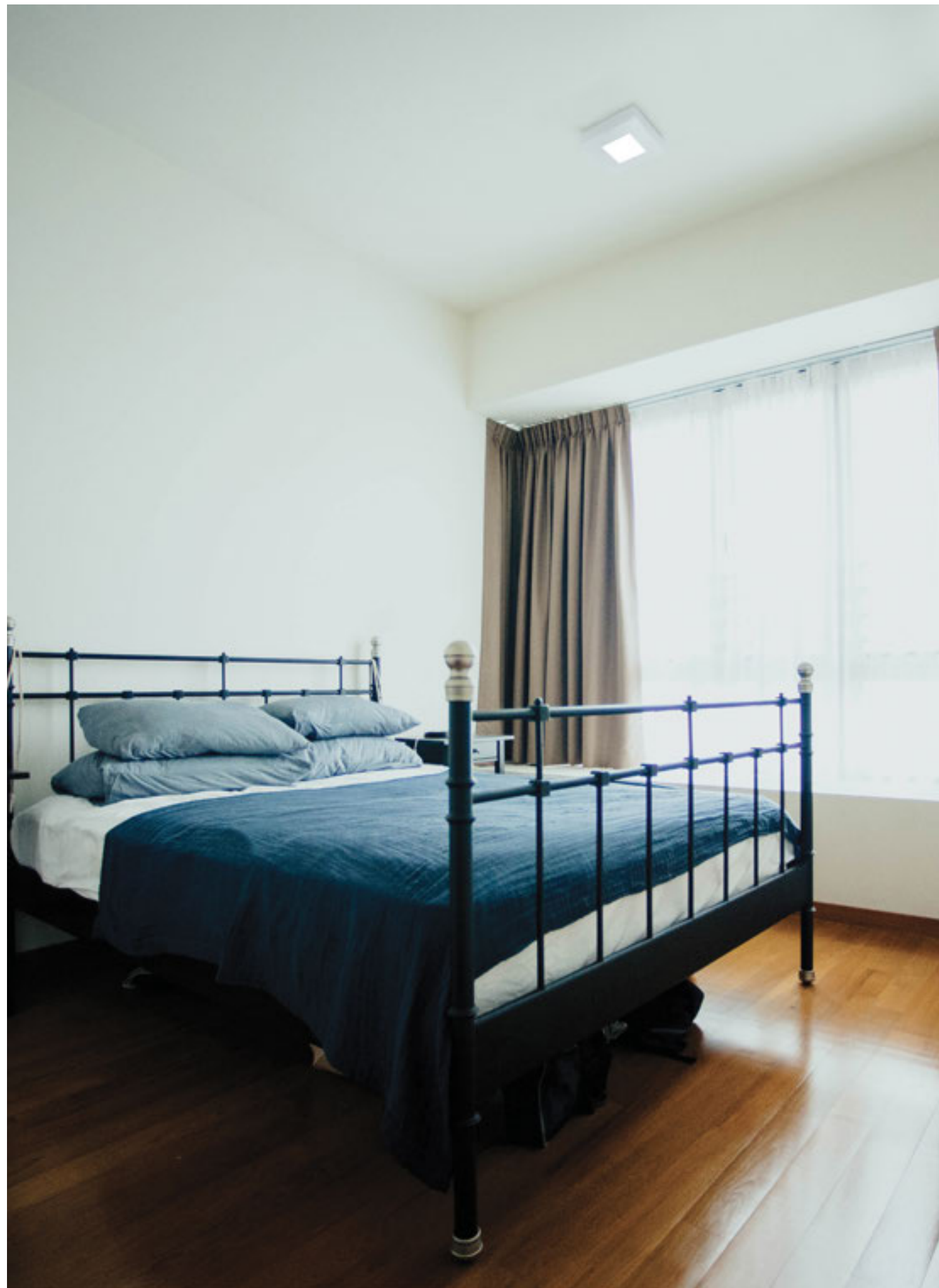

**A PLAFONE**  
Ceiling lighting  
Deckenleuchten  
Plafonniers

CRISTALY® made in Italy

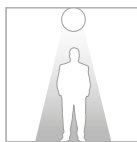

CASAMBI Pg.408



C.C. [m.A.]

IP20

# 8914D

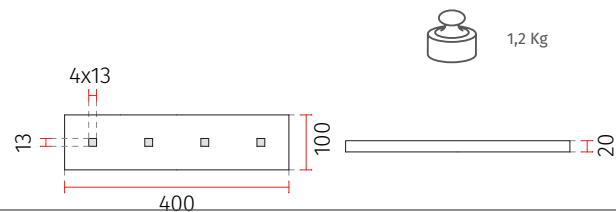

### DATI TECNICI / TECHNICAL DATA

8914D-3039	LED 4x4W-350mA-1400lm-3000°K-CRI85
8914D-2739	LED 4x4W-350mA-1320lm-2700°K-CRI85
8914D-4039	LED 4x4W-350mA-1480lm-4000°K-CRI85
026.252	DRIVER ON/OFF min12.6W max18.2W 350mA
026.221	DRIVER ON/OFF min9.8W max35W 350mA
026.219	DRIVER DIM PUSH/0-10V/DALI 16.1W 350mA
026.187	DRIVER DIM 0-10V 35W 350mA
026.185	DRIVER DIM PUSH/DALI 35W 350mA

### ACCESSORI / ACCESSORIES

099.142	Pg.415 Kit emergenza / Emergency Kit
---------	--------------------------------------

### DATI TECNICI / TECHNICAL DATA

8916E-30133	LED 8W-220-240V-1100lm-3000°K-CRI85
8916E-27133	LED 8W-220-240V-1050lm-2700°K-CRI85
8916E-40133	LED 8W-220-240V-1150lm-4000°K-CRI85

# NEW 8916E

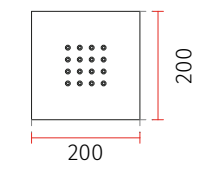

# 8914E NEW

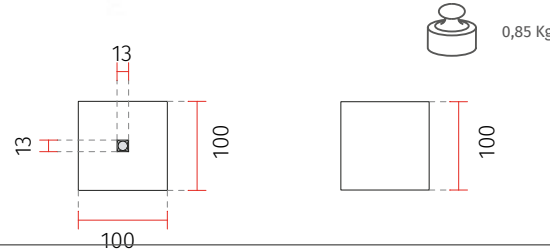

### DATI TECNICI / TECHNICAL DATA

8914E-30129	LED 4W-220-240V-350lm-3000°K-CRI85
8914E-27129	LED 4W-220-240V-330lm-2700°K-CRI85
8914E-40129	LED 4W-220-240V-670lm-4000°K-CRI85

Art. 8914D / 8903C



# 8914Q

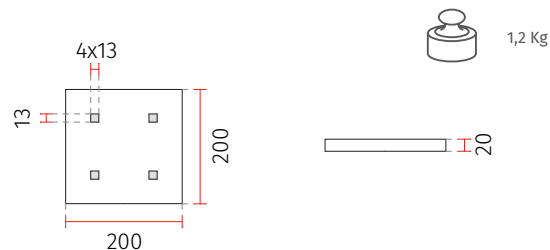

### DATI TECNICI / TECHNICAL DATA

8914Q-3039	LED 4x4W-350mA-1400lm-3000°K-CRI85
8914Q-2739	LED 4x4W-350mA-1320lm-2700°K-CRI85
8914Q-4039	LED 4x4W-350mA-1480lm-4000°K-CRI85
026.252	DRIVER ON/OFF min12.6W max18.2W 350mA
026.221	DRIVER ON/OFF min9.8W max35W 350mA
026.219	DRIVER DIM PUSH/0-10V/DALI 16.1W 350mA
026.187	DRIVER DIM 0-10V 35W 350mA
026.185	DRIVER DIM PUSH/DALI 35W 350mA

### ACCESSORI / ACCESSORIES

099.142	Pg.415 Kit emergenza / Emergency Kit
---------	--------------------------------------

IT Misure espresse in mm, tolleranza +/- 1-2 mm. L'azienda si riserva la facoltà di apportare variazioni di dati caratteristici, materiali, design, stili, tonalità, senza alcun preavviso.  
EN Measures in mm, tolerance +/- 1/2 mm. The company reserves the right to carry out variations to technical details, materials, design, style, colors with no previous notice.

DE Die Masse sind in mm, mit einer Tolleranz von +/- 1-2 mm ausgedrückt, Die Firma behält sich das Recht vor ohne Voranmeldung Änderungen an den Werkstoffen, am Design, am Stil und an der Färbung vorzunehmen.  
FR Mesures en mm, tolérance +/- 1/2 mm. La société se réserve le droit de modifier sans préavis les détails techniques, les matériaux, le design, le style et les couleurs.

**A PLAFONE**  
Ceiling lighting  
Deckenleuchten  
Plafonniers

CRISTALY®

made in Italy

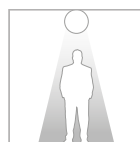

Art. 8943N



**DATI TECNICI / TECHNICAL DATA**

**8943D-35** GU10 Ø35 MAX 4x5W-240V

Versione con lampadina inclusa / Version with bulb included  
Version mit Lampe enthalten / Version avec ampoule incluse:

**8943D-35-L** GU10 Ø35 MAX 4x5W-240V + 4xL007

**ACCESSORI / ACCESSORIES**

**L007** LED GU10 Ø35mm LED 3.2W-220-240V

**8943D**

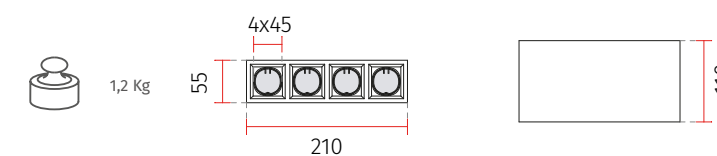

**DATI TECNICI / TECHNICAL DATA**

**8943H-35** GU10 Ø35 MAX 8x5W-240V

Versione con lampadina inclusa / Version with bulb included  
Version mit Lampe enthalten / Version avec ampoule incluse:

**8943H-35-L** GU10 Ø35 MAX 8x5W-240V + 8xL007

**ACCESSORI / ACCESSORIES**

**L007** LED GU10 Ø35mm LED 3.2W-220-240V

**8943H**

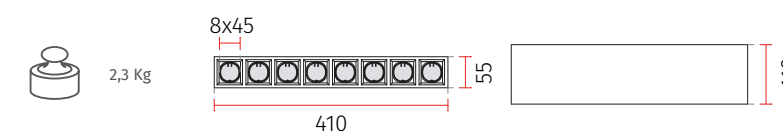

**DATI TECNICI / TECHNICAL DATA**

**8943N-35** GU10 Ø35 MAX 12x5W-240V

Versione con lampadina inclusa / Version with bulb included  
Version mit Lampe enthalten / Version avec ampoule incluse:

**8943N-35-L** GU10 Ø35 MAX 12x5W-240V + 12xL007

**ACCESSORI / ACCESSORIES**

**L007** LED GU10 Ø35mm LED 3.2W-220-240V

**8943N**



**DATI TECNICI / TECHNICAL DATA**

**8943O-35** GU10 Ø35 MAX 4x5W-240V

Versione con lampadina inclusa / Version with bulb included  
Version mit Lampe enthalten / Version avec ampoule incluse:

**8943O-35-L** GU10 Ø35 MAX 4x5W-240V + 4xL007

**ACCESSORI / ACCESSORIES**

**L007** LED GU10 Ø35mm LED 3.2W-220-240V

**8943O**

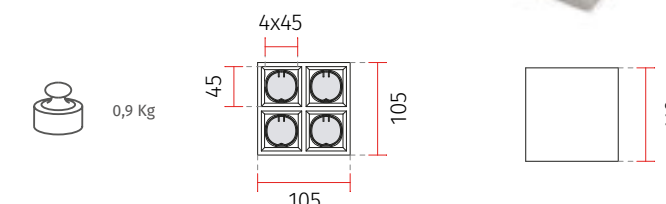

IT Misure espresse in mm, tolleranza +/- 1-2 mm. L'azienda si riserva la facoltà di apportare variazioni di dati caratteristici, materiali, design, stili, tonalità, senza alcun preavviso.  
EN Measures in mm, tolerance +/- 1/2 mm. The company reserves the right to carry out variations to technical details, materials, design, style, colors with no previous notice.

DE Die Masse sind in mm, mit einer Tolleranz von +/- 1-2 mm ausgedrückt, Die Firma behält sich das Recht vor ohne Voranmeldung Änderungen an den Werkstoffen, am Design, am Stil und an der Färbung vorzunehmen.  
FR Mesures en mm, tolérance +/- 1/2 mm. La société se réserve le droit de modifier sans préavis les détails techniques, les matériaux, le design, le style et les couleurs.



# A PLAFONE

Ceiling lighting  
Deckenleuchten  
Plafonniers

CRISTALY® made in Italy

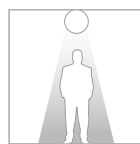

FINITURE SU RICHIESTA / FINISHES ON DEMAND  
OBERFLÄCHENVERARBEITUNGEN AUF NACHFRAGE / FINITIONS SUR DEMANDE: CASAMBI Pg.408



Art. 8949A - Agriturismo al Filò - Vicenza, Italy  
Arch. Franco Parise



Diffusore in policarbonato satinato  
Satin finish polycarbonate diffuser  
Abdeckung aus satiniertem Polycarbonat  
Diffuseur en polycarbonate satiné



## 8949A

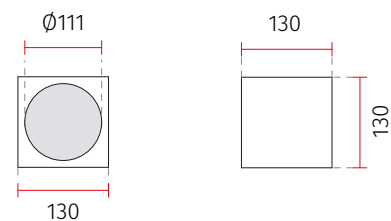

DATI TECNICI / TECHNICAL DATA	
8949A-35	GU10 Ø111 MAX 35W-240V
8949A-92	G53 (QR111) MAX 20W-12V
8949A-3008	LED 13W-700mA-1600lm-3000°K-CRI90
8949A-2708	LED 13W-700mA-1500lm-2700°K-CRI90
8949A-4008	LED 13W-700mA-1700lm-4000°K-CRI90
026.255	DRIVER ON/OFF min11.9W max18.2W 700mA
026.256	DRIVER ON/OFF min24.9W max35.7W 700mA
026.219	DRIVER DIM PUSH/0-10V/DALI 19.6W 700mA
026.207	DRIVER DIM 0-10V 60.2W 700mA
026.206	DRIVER DIM PUSH/DALI 60.2W 700mA
ACCESSORI / ACCESSORIES	
099.142	Pg.415 Kit emergenza / Emergency Kit

IT Misure espresse in mm, tolleranza +/- 1-2 mm. L'azienda si riserva la facoltà di apportare variazioni di dati caratteristici, materiali, design, stili, tonalità, senza alcun preavviso.  
EN Measures in mm, tolerance +/- 1/2 mm. The company reserves the right to carry out variations to technical details, materials, design, style, colors with no previous notice.

DATI TECNICI / TECHNICAL DATA	
8949B-35	GU10 Ø111 MAX 35W-240V
8949B-92	G53 (QR111) MAX 20W-12V
8949B-3008	LED 13W-700mA-1600lm-3000°K-CRI90
8949B-2708	LED 13W-700mA-1500lm-2700°K-CRI90
8949B-4008	LED 13W-700mA-1700lm-4000°K-CRI90
026.255	DRIVER ON/OFF min11.9W max18.2W 700mA
026.256	DRIVER ON/OFF min24.9W max35.7W 700mA
026.219	DRIVER DIM PUSH/0-10V/DALI 19.6W 700mA
026.207	DRIVER DIM 0-10V 60.2W 700mA
026.206	DRIVER DIM PUSH/DALI 60.2W 700mA
8949B-3010	LED 18W-500mA-2400lm-3000°K-CRI85
8949B-2710	LED 18W-500mA-2280lm-2700°K-CRI85
8949B-4010	LED 18W-500mA-2540lm-4000°K-CRI85
026.254	DRIVER ON/OFF min16.5W max23.5W 500mA
026.219	DRIVER DIM PUSH/0-10V/DALI 20W 500mA
026.207	DRIVER DIM 0-10V 45W 500mA
026.206	DRIVER DIM PUSH/DALI 45W 500mA

ACCESSORI / ACCESSORIES	
099.142	Pg.415 Kit emergenza / Emergency Kit

## 8949B

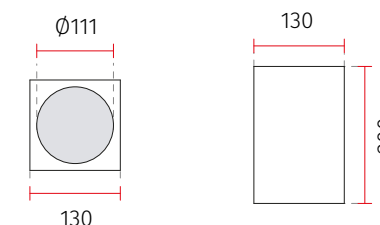

DATI TECNICI / TECHNICAL DATA	
8949C-35	GU10 Ø111 MAX 35W-240V
8949C-92	G53 (QR111) MAX 20W-12V
8949C-3008	LED 13W-700mA-1600lm-3000°K-CRI90
8949C-2708	LED 13W-700mA-1500lm-2700°K-CRI90
8949C-4008	LED 13W-700mA-1700lm-4000°K-CRI90
026.255	DRIVER ON/OFF min11.9W max18.2W 700mA
026.256	DRIVER ON/OFF min24.9W max35.7W 700mA
026.219	DRIVER DIM PUSH/0-10V/DALI 19.6W 700mA
026.207	DRIVER DIM 0-10V 60.2W 700mA
026.206	DRIVER DIM PUSH/DALI 60.2W 700mA
8949C-3010	LED 18W-500mA-2400lm-3000°K-CRI85
8949C-2710	LED 18W-500mA-2280lm-2700°K-CRI85
8949C-4010	LED 18W-500mA-2540lm-4000°K-CRI85
026.254	DRIVER ON/OFF min16.5W max23.5W 500mA
026.219	DRIVER DIM PUSH/0-10V/DALI 20W 500mA
026.207	DRIVER DIM 0-10V 45W 500mA
026.206	DRIVER DIM PUSH/DALI 45W 500mA

ACCESSORI / ACCESSORIES	
099.142	Pg.415 Kit emergenza / Emergency Kit

## 8949C

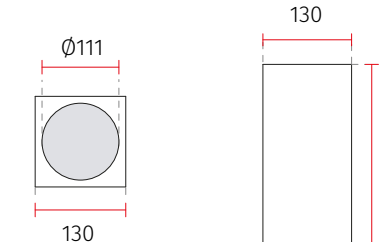

DE Die Masse sind in mm, mit einer Tolleranz von +/- 1-2 mm ausgedrückt, Die Firma behält sich das Recht vor ohne Voranmeldung Änderungen an den Werkstoffen, am Design, am Stil und an der Färbung vorzunehmen.  
FR Mesures en mm, tolérance +/- 1/2 mm. La société se réserve le droit de modifier sans préavis les détails techniques, les matériaux, le design, le style et les couleurs.

# A PLAFONE

Ceiling lighting  
Deckenleuchten  
Plafonniers

CRISTALY® made in Italy

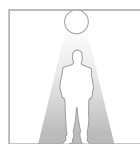

CASAMBI Pg.408

Art. 8952A / 8952B / 8952C



Diffusore in policarbonato satinato  
Satin finish polycarbonate diffuser  
Abdeckung aus satiniertem Polycarbonat  
Diffuseur en polycarbonate satiné



## 8952A



1,4 Kg

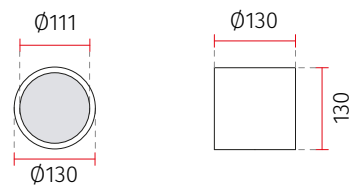

### DATI TECNICI / TECHNICAL DATA

8952A-35	GU10 $\phi$ 111 MAX 35W-240V
8952A-92	G53 (QR111) MAX 20W-12V
8952A-3008	LED 13W-700mA-1600lm-3000°K-CRI90
8952A-2708	LED 13W-700mA-1500lm-2700°K-CRI90
8952A-4008	LED 13W-700mA-1700lm-4000°K-CRI90
026.255	DRIVER ON/OFF min11.9W max18.2W 700mA
026.256	DRIVER ON/OFF min24.9W max35.7W 700mA
026.219	DRIVER DIM PUSH/0-10V/DALI 19.6W 700mA
026.207	DRIVER DIM 0-10V 60.2W 700mA
026.206	DRIVER DIM PUSH/DALI 60.2W 700mA

### ACCESSORI / ACCESSORIES

099.142	Pg.415 Kit emergenza / Emergency Kit
---------	--------------------------------------

### DATI TECNICI / TECHNICAL DATA

8952B-35	GU10 $\phi$ 111 MAX 35W-240V
8952B-92	G53 (QR111) MAX 20W-12V
8952B-3008	LED 13W-700mA-1600lm-3000°K-CRI90
8952B-2708	LED 13W-700mA-1500lm-2700°K-CRI90
8952B-4008	LED 13W-700mA-1700lm-4000°K-CRI90
026.255	DRIVER ON/OFF min11.9W max18.2W 700mA
026.256	DRIVER ON/OFF min24.9W max35.7W 700mA
026.219	DRIVER DIM PUSH/0-10V/DALI 19.6W 700mA
026.207	DRIVER DIM 0-10V 60.2W 700mA
026.206	DRIVER DIM PUSH/DALI 60.2W 700mA
8952B-3010	LED 18W-500mA-2400lm-3000°K-CRI85
8952B-2710	LED 18W-500mA-2280lm-2700°K-CRI85
8952B-4010	LED 18W-500mA-2540lm-4000°K-CRI85
026.254	DRIVER ON/OFF min16.5W max23.5W 500mA
026.219	DRIVER DIM PUSH/0-10V/DALI 20W 500mA
026.207	DRIVER DIM 0-10V 45W 500mA
026.206	DRIVER DIM PUSH/DALI 45W 500mA

### ACCESSORI / ACCESSORIES

099.142	Pg.415 Kit emergenza / Emergency Kit
---------	--------------------------------------

## 8952B



2,4 Kg

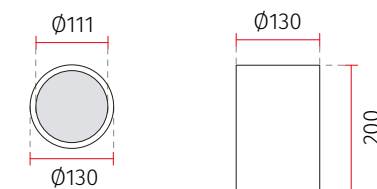

### DATI TECNICI / TECHNICAL DATA

8952C-35	GU10 $\phi$ 111 MAX 35W-240V
8952C-92	G53 (QR111) MAX 20W-12V
8952C-3008	LED 13W-700mA-1600lm-3000°K-CRI90
8952C-2708	LED 13W-700mA-1500lm-2700°K-CRI90
8952C-4008	LED 13W-700mA-1700lm-4000°K-CRI90
026.255	DRIVER ON/OFF min11.9W max18.2W 700mA
026.256	DRIVER ON/OFF min24.9W max35.7W 700mA
026.219	DRIVER DIM PUSH/0-10V/DALI 19.6W 700mA
026.207	DRIVER DIM 0-10V 60.2W 700mA
026.206	DRIVER DIM PUSH/DALI 60.2W 700mA
8952C-3010	LED 18W-500mA-2400lm-3000°K-CRI85
8952C-2710	LED 18W-500mA-2280lm-2700°K-CRI85
8952C-4010	LED 18W-500mA-2540lm-4000°K-CRI85
026.254	DRIVER ON/OFF min16.5W max23.5W 500mA
026.219	DRIVER DIM PUSH/0-10V/DALI 20W 500mA
026.207	DRIVER DIM 0-10V 45W 500mA
026.206	DRIVER DIM PUSH/DALI 45W 500mA

### ACCESSORI / ACCESSORIES

099.142	Pg.415 Kit emergenza / Emergency Kit
---------	--------------------------------------

## 8952C



3,2 Kg

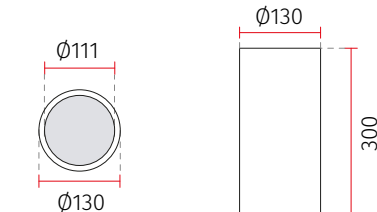

IT Misure espresse in mm, tolleranza +/- 1-2 mm. L'azienda si riserva la facoltà di apportare variazioni di dati caratteristici, materiali, design, stili, tonalità, senza alcun preavviso.  
EN Measures in mm, tolerance +/- 1/2 mm. The company reserves the right to carry out variations to technical details, materials, design, style, colors with no previous notice.

DE Die Masse sind in mm, mit einer Tolleranz von +/- 1-2 mm ausgedrückt. Die Firma behält sich das Recht vor ohne Voranmeldung Änderungen an den Werkstoffen, am Design, am Stil und an der Färbung vorzunehmen.  
FR Mesures en mm, tolérance +/- 1/2 mm. La société se réserve le droit de modifier sans préavis les détails techniques, les matériaux, le design, le style et les couleurs.

# INCASSO A PLAFONE E A PARETE

Ceiling and wall recessed lighting  
 Wand- und Decken-Einbauleuchten  
 Encastrés Muraux et Plafonds

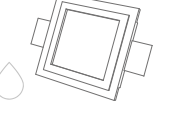
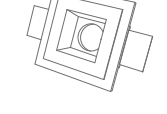
					
4039B p.247	4040B p.247	4045B p.249	4045C p.249	4046 p.251	4105 p.251
					
4052 p.255	4053 p.255	4054 p.255	4174 p.259	4175 p.259	4176 p.259
					
4178 p.261	4179 p.261	4184 p.261	4180 p.265	4180A p.265	4180B p.265
					
4181 p.267	4183 p.267	4210 p.267	4215 p.269	4216 p.269	4218 p.271
					
4218A p.271	4219 p.271	4275 p.273	4276 p.273	4277 p.275	4278 p.275
					
4280 p.277	4281 p.277				

# INCASSO A PLAFONE E A PARETE

## Ceiling and wall recessed lighting

### Wand- und Decken-Einbauleuchten

### Encastrés Muraux et Plafonds

CRISTALY®

made in Italy

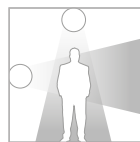

IP20

CASAMBI Pg.408

Art. 4039B - Private house - Grenoble, France



Lampadina orientabile di 30°  
Adjustable spotlight 30°  
Schwenkbare Leuchtmittel 30°  
Ampoule pivotante 30°



Sistema Multitaglia  
Multi-size system  
Schwenkbare Leuchtmittel 30°  
P.417



#### DATI TECNICI / TECHNICAL DATA

4039B-35	GU10 Ø111 MAX 35W-240V
4039B-92	G53 (QR111) MAX 50W-12V
4039B-3006	LED 6.5W-350mA-850lm-3000°K-CRI90
4039B-2706	LED 6.5W-350mA-800lm-2700°K-CRI90
4039B-4006	LED 6.5W-350mA-900lm-4000°K-CRI90
026.251	DRIVER ON/OFF min6W max8.8W 350mA
026.252	DRIVER ON/OFF min12.6W max18.2W 350mA
026.221	DRIVER ON/OFF min9.8W max35W 350mA
026.219	DRIVER DIM PUSH/0-10V/DALI 16.1W 350mA
026.187	DRIVER DIM 0-10V 35W 350mA
026.185	DRIVER DIM PUSH/DALI 35W 350mA
4039B-3008	LED 13W-700mA-1600lm-3000°K-CRI90
4039B-2708	LED 13W-700mA-1500lm-2700°K-CRI90
4039B-4008	LED 13W-700mA-1700lm-4000°K-CRI90
026.255	DRIVER ON/OFF min11.9W max18.2W 700mA
026.256	DRIVER ON/OFF min24.9W max35.7W 700mA
026.219	DRIVER DIM PUSH/0-10V/DALI 19.6W 700mA
026.207	DRIVER DIM 0-10V 60.2W 700mA
026.206	DRIVER DIM PUSH/DALI 60.2W 700mA

#### ACCESSORI / ACCESSORIES

023.475	Controcassa per muratura / Housing box for brickwork / Einbaugehäuse für Betonwand / Boîtier pour béton/briques [265x265x150mm]
099.142	Pg.415 Kit emergenza / Emergency Kit

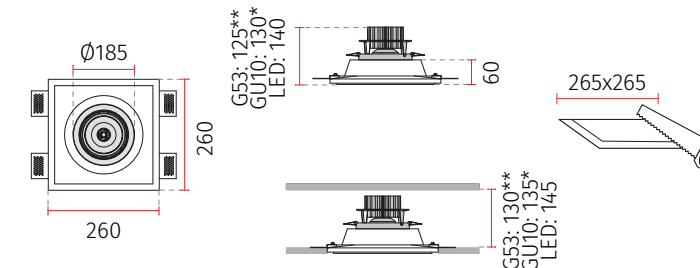

\*= Altezza inclusa lampadina OSRAM GU10 H75 mm e portalamпада / height including OSRAM GU10 H75 mm lamp and lampholder / Höhe inkl. OSRAM GU10 H75mm Lampe und Fassung / Hauteur compris ampoule OSRAM GU10 H75mm et source

\*\*= Altezza inclusa lampadina OSRAM H55 mm e portalamпада / height including OSRAM H55 mm lamp and lampholder / Höhe inkl. OSRAM H55mm Lampe und Fassung / Hauteur compris ampoule OSRAM H55mm et source

# 4040B



2,45 Kg

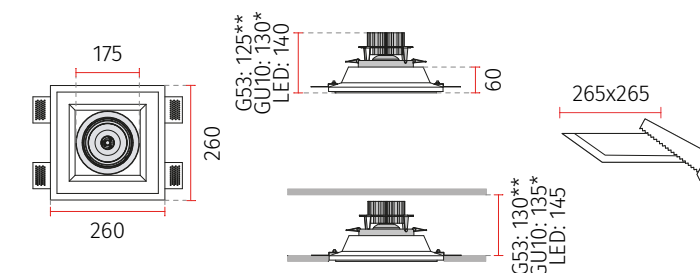

\*= Altezza inclusa lampadina OSRAM GU10 H75 mm e portalamпада / height including OSRAM GU10 H75 mm lamp and lampholder / Höhe inkl. OSRAM GU10 H75mm Lampe und Fassung / Hauteur compris ampoule OSRAM GU10 H75mm et source

\*\*= Altezza inclusa lampadina OSRAM H55 mm e portalamпада / height including OSRAM H55 mm lamp and lampholder / Höhe inkl. OSRAM H55mm Lampe und Fassung / Hauteur compris ampoule OSRAM H55mm et source

#### DATI TECNICI / TECHNICAL DATA

4040B-35	GU10 Ø111 MAX 35W-240V
4040B-92	G53 (QR111) MAX 50W-12V
4040B-3006	LED 6.5W-350mA-850lm-3000°K-CRI90
4040B-2706	LED 6.5W-350mA-800lm-2700°K-CRI90
4040B-4006	LED 6.5W-350mA-900lm-4000°K-CRI90
026.251	DRIVER ON/OFF min6W max8.8W 350mA
026.252	DRIVER ON/OFF min12.6W max18.2W 350mA
026.221	DRIVER ON/OFF min9.8W max35W 350mA
026.219	DRIVER DIM PUSH/0-10V/DALI 16.1W 350mA
026.187	DRIVER DIM 0-10V 35W 350mA
026.185	DRIVER DIM PUSH/DALI 35W 350mA
4040B-3008	LED 13W-700mA-1600lm-3000°K-CRI90
4040B-2708	LED 13W-700mA-1500lm-2700°K-CRI90
4040B-4008	LED 13W-700mA-1700lm-4000°K-CRI90
026.255	DRIVER ON/OFF min11.9W max18.2W 700mA
026.256	DRIVER ON/OFF min24.9W max35.7W 700mA
026.219	DRIVER DIM PUSH/0-10V/DALI 19.6W 700mA
026.207	DRIVER DIM 0-10V 60.2W 700mA
026.206	DRIVER DIM PUSH/DALI 60.2W 700mA

#### ACCESSORI / ACCESSORIES

023.475	Controcassa per muratura / Housing box for brickwork / Einbaugehäuse für Betonwand / Boîtier pour béton/briques [265x265x150mm]
099.142	Pg.415 Kit emergenza / Emergency Kit

IT Misure espresse in mm, tolleranza +/- 1-2 mm. L'azienda si riserva la facoltà di apportare variazioni di dati caratteristici, materiali, design, stili, tonalità, senza alcun preavviso.  
EN Measures in mm, tolerance +/- 1/2 mm. The company reserves the right to carry out variations to technical details, materials, design, style, colors with no previous notice.

DE Die Masse sind in mm, mit einer Tolleranz von +/- 1-2 mm ausgedrückt, Die Firma behält sich das Recht vor ohne Voranmeldung Änderungen an den Werkstoffen, am Design, am Stil und an der Färbung vorzunehmen.  
FR Mesures en mm, tolérance +/- 1/2 mm. La société se réserve le droit de modifier sans préavis les détails techniques, les matériaux, le design, le style et les couleurs.

# INCASSO A PLAFONE E A PARETE

Ceiling and wall recessed lighting  
Wand- und Decken-Einbauleuchten  
Encastrés Muraux et Plafonds

CRISTALY®

made in Italy

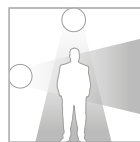

CASAMBI Pg.408

Art. 4045B - Office - Vicenza, Italy



Sistema Multitaglia  
Multi-size system  
P.417



4045B:  
Diffusore in policarbonato satinato  
Satin finish polycarbonate diffuser  
Abdeckung aus satiniertem Polycarbonat  
Diffuseur en polycarbonate satiné



## DATI TECNICI / TECHNICAL DATA

4045B-35	GU10 Ø111 MAX 20W-240V
4045B-92	G53 (QR111) MAX 20W-12V
4045B-3006	LED 6.5W-350mA-850lm-3000°K-CRI90
4045B-2706	LED 6.5W-350mA-800lm-2700°K-CRI90
4045B-4006	LED 6.5W-350mA-900lm-4000°K-CRI90
026.251	DRIVER ON/OFF min6W max8.8W 350mA
026.252	DRIVER ON/OFF min12.6W max18.2W 350mA
026.221	DRIVER ON/OFF min9.8W max35W 350mA
026.219	DRIVER DIM PUSH/0-10V/DALI 16.1W 350mA
026.187	DRIVER DIM 0-10V 35W 350mA
026.185	DRIVER DIM PUSH/DALI 35W 350mA
4045B-3008	LED 13W-700mA-1600lm-3000°K-CRI90
4045B-2708	LED 13W-700mA-1500lm-2700°K-CRI90
4045B-4008	LED 13W-700mA-1700lm-4000°K-CRI90
026.255	DRIVER ON/OFF min11.9W max18.2W 700mA
026.256	DRIVER ON/OFF min24.9W max35.7W 700mA
026.219	DRIVER DIM PUSH/0-10V/DALI 19.6W 700mA
026.207	DRIVER DIM 0-10V 60.2W 700mA
026.206	DRIVER DIM PUSH/DALI 60.2W 700mA

## ACCESSORI / ACCESSORIES

023.477	Controcassa per muratura / Housing box for brickwork / Einbauehäuse für Betonwand / Boîtier pour béton/briques [255x255x170mm]
099.142	Pg.415 Kit emergenza / Emergency Kit

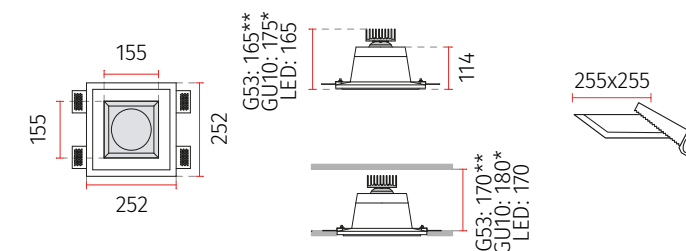

\*= Altezza inclusa lampadina OSRAM GU10 H75 mm e portalampada / height including OSRAM GU10 H75 mm lamp and lampholder / Höhe inkl. OSRAM GU10 H75mm Lampe und Fassung / Hauteur compris ampoule OSRAM GU10 H75mm et source

\*\*= Altezza inclusa lampadina OSRAM H55 mm e portalampada / height including OSRAM H55 mm lamp and lampholder / Höhe inkl. OSRAM H55mm Lampe und Fassung / Hauteur compris ampoule OSRAM H55mm et source

# 4045B



2,55 Kg

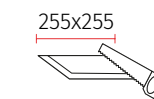

## DATI TECNICI / TECHNICAL DATA

4045C-35	GU10 Ø111 MAX 20W-240V
4045C-92	G53 (QR111) MAX 20W-12V
4045C-3006	LED 6.5W-350mA-850lm-3000°K-CRI90
4045C-2706	LED 6.5W-350mA-800lm-2700°K-CRI90
4045C-4006	LED 6.5W-350mA-900lm-4000°K-CRI90
026.251	DRIVER ON/OFF min6W max8.8W 350mA
026.252	DRIVER ON/OFF min12.6W max18.2W 350mA
026.221	DRIVER ON/OFF min9.8W max35W 350mA
026.219	DRIVER DIM PUSH/0-10V/DALI 16.1W 350mA
026.187	DRIVER DIM 0-10V 35W 350mA
026.185	DRIVER DIM PUSH/DALI 35W 350mA
4045C-3008	LED 13W-700mA-1600lm-3000°K-CRI90
4045C-2708	LED 13W-700mA-1500lm-2700°K-CRI90
4045C-4008	LED 13W-700mA-1700lm-4000°K-CRI90
026.255	DRIVER ON/OFF min11.9W max18.2W 700mA
026.256	DRIVER ON/OFF min24.9W max35.7W 700mA
026.219	DRIVER DIM PUSH/0-10V/DALI 19.6W 700mA
026.207	DRIVER DIM 0-10V 60.2W 700mA
026.206	DRIVER DIM PUSH/DALI 60.2W 700mA

## ACCESSORI / ACCESSORIES

023.477	Controcassa per muratura / Housing box for brickwork / Einbauehäuse für Betonwand / Boîtier pour béton/briques [200x200x120mm]
099.142	Pg.415 Kit emergenza / Emergency Kit

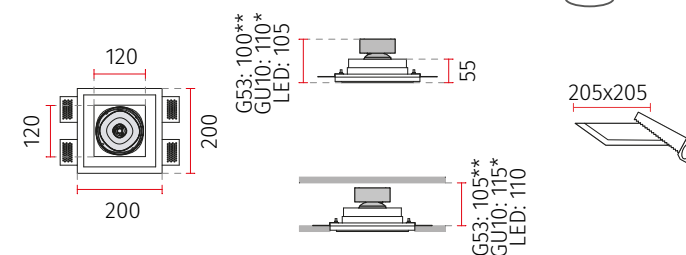

\*= Altezza inclusa lampadina OSRAM GU10 H75 mm e portalampada / height including OSRAM GU10 H75 mm lamp and lampholder / Höhe inkl. OSRAM GU10 H75mm Lampe und Fassung / Hauteur compris ampoule OSRAM GU10 H75mm et source

\*\*= Altezza inclusa lampadina OSRAM H55 mm e portalampada / height including OSRAM H55 mm lamp and lampholder / Höhe inkl. OSRAM H55mm Lampe und Fassung / Hauteur compris ampoule OSRAM H55mm et source

# 4045C



1,65 Kg

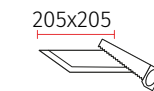

# INCASSO A PLAFONE E A PARETE

## Ceiling and wall recessed lighting

### Wand- und Decken-Einbauleuchten

### Encastrés Muraux et Plafonds

CRISTALY®

made in Italy

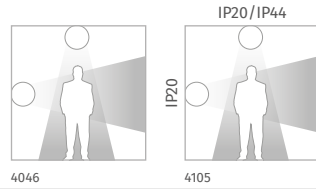

C.C. [m.A.]



IP20

4046 IP20/IP44

4105

TUNABLE WHITE Pg.412

CASAMBI Pg.408

#### DATI TECNICI / TECHNICAL DATA

4046-3025	LED 16W-700mA-2200lm-3000°K-CRI85
4046-2725	LED 16W-700mA-2090lm-2700°K-CRI85
4046-4025	LED 16W-700mA-2330lm-4000°K-CRI85
026.255	DRIVER ON/OFF min11.9W max18.2W 700mA
026.256	DRIVER ON/OFF min24.9W max35.7W 700mA
026.219	DRIVER DIM PUSH /0-10V/DALI 19.6W 700mA
026.207	DRIVER DIM 0-10V 60.2W 700mA
026.206	DRIVER DIM PUSH/DALI 60.2W 700mA

#### ACCESSORI / ACCESSORIES

099.142	Pg.415 Kit emergenza / Emergency Kit
---------	--------------------------------------



# 4046

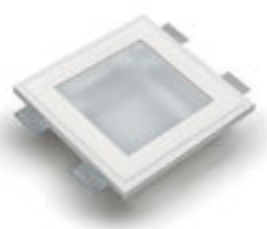

3 Kg

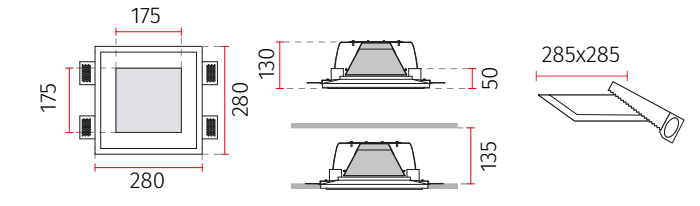

Art. 4046 - Shop - Italy



Diffusore in vetro  
Glass diffuser  
Glasabdeckung  
Diffuseur en verre

#### DATI TECNICI / TECHNICAL DATA

4105-3024	LED 8W-350mA-1100lm-3000°K-CRI85
4105-2724	LED 8W-350mA-1050lm-2700°K-CRI85
4105-4024	LED 8W-350mA-1160lm-4000°K-CRI85
026.251	DRIVER ON/OFF min6W max8.8W 350mA
026.252	DRIVER ON/OFF min12.6W max18.2W 350mA
026.221	DRIVER ON/OFF min9.8W max35W 350mA
026.219	DRIVER DIM PUSH /0-10V/DALI 16.1W 350mA
026.187	DRIVER DIM 0-10V 35W 350mA
026.185	DRIVER DIM PUSH/DALI 35W 350mA
4105-3025	LED 16W-700mA-2200lm-3000°K-CRI85
4105-2725	LED 16W-700mA-2090lm-2700°K-CRI85
4105-4025	LED 16W-700mA-2330lm-4000°K-CRI85
026.255	DRIVER ON/OFF min11.9W max18.2W 700mA
026.256	DRIVER ON/OFF min24.9W max35.7W 700mA
026.219	DRIVER DIM PUSH /0-10V/DALI 19.6W 700mA
026.207	DRIVER DIM 0-10V 60.2W 700mA
026.206	DRIVER DIM PUSH/DALI 60.2W 700mA

#### ACCESSORI / ACCESSORIES

023.471	Controcassa per muratura / Housing box for brickwork / Einbaugeschäube für Betonwand / Boîtier pour béton/briques [175x205x75mm]
099.142	Pg.415 Kit emergenza / Emergency Kit

# 4105



1,2 Kg

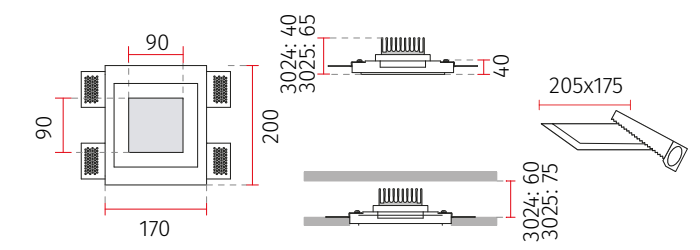

IT Misure espresse in mm, tolleranza +/- 1-2 mm. L'azienda si riserva la facoltà di apportare variazioni di dati caratteristici, materiali, design, stili, tonalità, senza alcun preavviso.  
EN Measures in mm, tolerance +/- 1/2 mm. The company reserves the right to carry out variations to technical details, materials, design, style, colors with no previous notice.

DE Die Masse sind in mm, mit einer Tolleranz von +/- 1-2 mm ausgedrückt, Die Firma behält sich das Recht vor ohne Voranmeldung Änderungen an den Werkstoffen, am Design, am Stil und an der Färbung vorzunehmen.  
FR Mesures en mm, tolérance +/- 1/2 mm. La société se réserve le droit de modifier sans préavis les détails techniques, les matériaux, le design, le style et les couleurs.

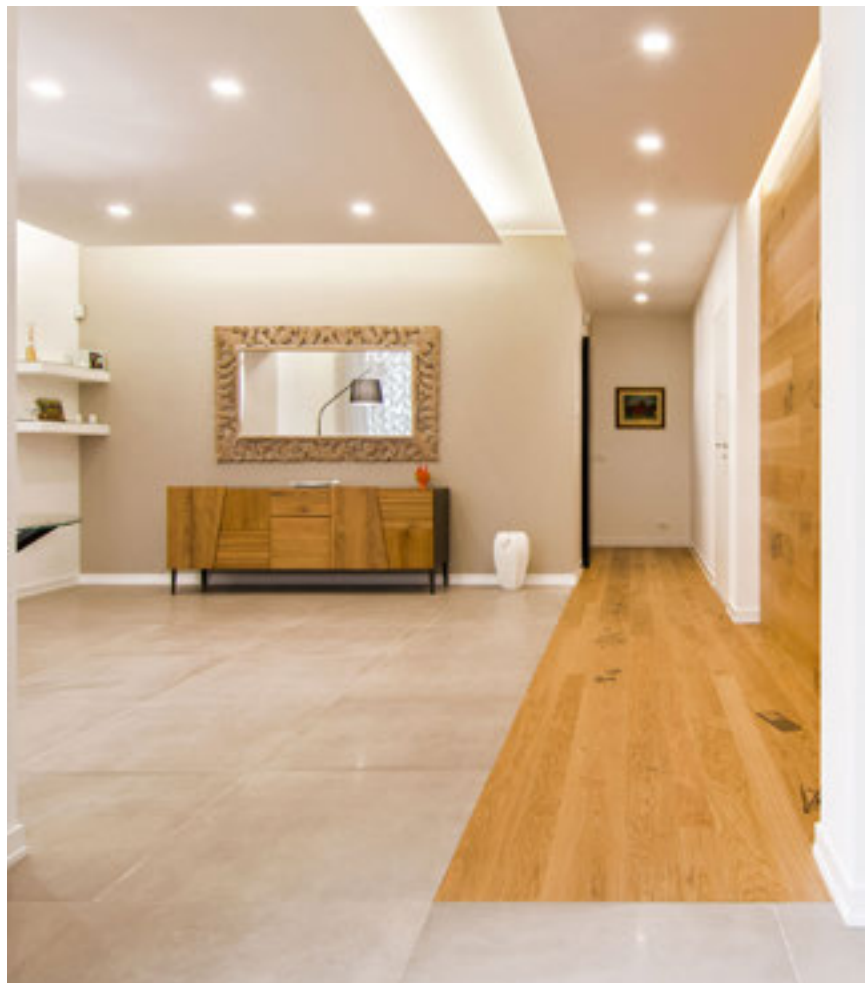
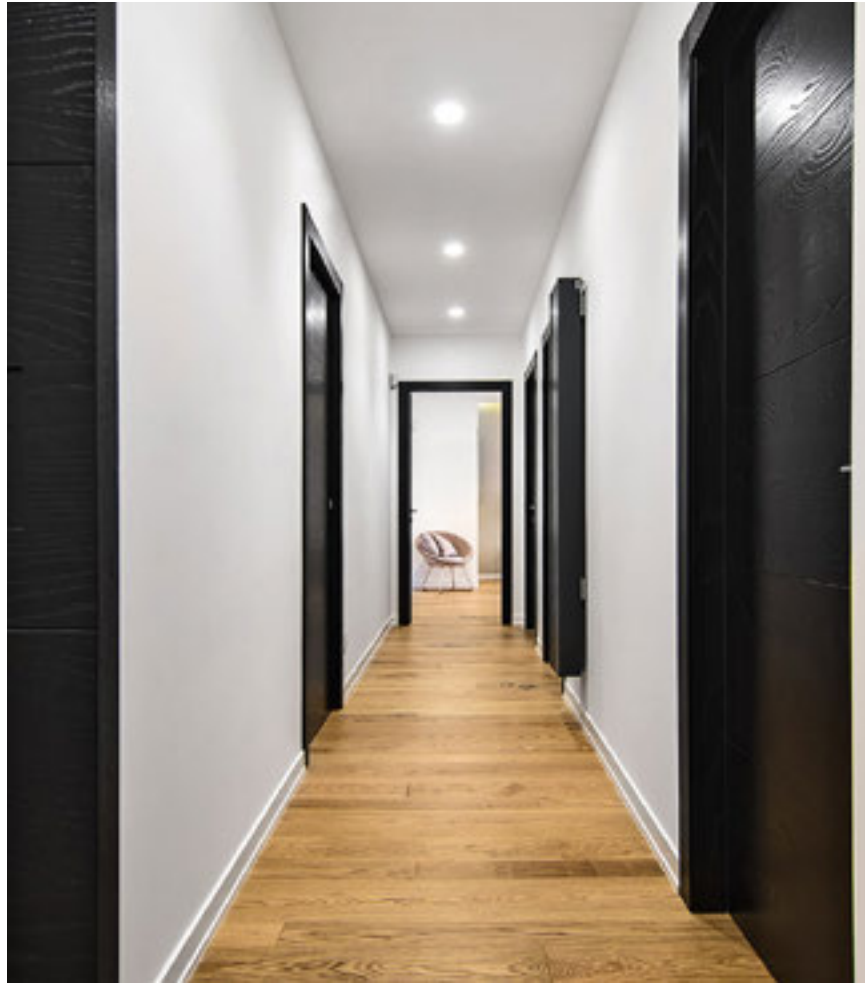

# INCASSO A PLAFONE E A PARETE

## Ceiling and wall recessed lighting

### Wand- und Decken-Einbauleuchten

### Encastrés Muraux et Plafonds

CRISTALY®

made in Italy

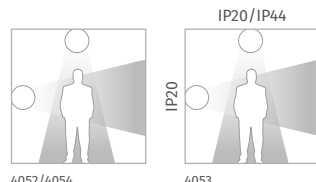

CASAMBI Pg.408

Art. 4054 - Private house - Bochum, Germany



Parte elettrica LED  
LED electrical part  
LED elektrischer Teil  
Partie électrique LED



Diffusore in vetro  
Glass diffuser  
Glasabdeckung  
Diffuseur en verre

#### DATI TECNICI / TECHNICAL DATA

4052-3003	LED 13.5W-24Vdc-1500lm-3000°K-CRI90
4052-2703	LED 13.5W-24Vdc-1400lm-2700°K-CRI90
4052-4003	LED 13.5W-24Vdc-1575lm-4000°K-CRI90
026.259	DRIVER ON/OFF 36W 24V
026.260	DRIVER ON/OFF 60W 24V
026.261	DRIVER ON/OFF 150W 24V
026.262	DRIVER ON/OFF 240W 24V
026.219	DRIVER DIM PUSH/0-10V/DALI 21.6W 24V
026.209	DRIVER DIM PUSH/1-10V 60W 24V
026.190+026.261	DRIVER DIM PUSH/0-10V/DALI 150W 24V
026.190+026.262	DRIVER DIM PUSH/0-10V/DALI 240W 24V

#### ACCESSORI / ACCESSORIES

023.454	Controcassa per muratura / Housing box for brickwork / Einbaugehäuse für Betonwand / Boîtier pour béton/briques [355x215x100mm]
099.142	Pg.415 Kit emergenza / Emergency Kit

#### DATI TECNICI / TECHNICAL DATA

4053-3006	LED 6.5W-350mA-850lm-3000°K-CRI90
4053-2706	LED 6.5W-350mA-800lm-2700°K-CRI90
4053-4006	LED 6.5W-350mA-900lm-4000°K-CRI90
026.251	DRIVER ON/OFF min6W max8.8W 350mA
026.252	DRIVER ON/OFF min12.6W max18.2W 350mA
026.221	DRIVER ON/OFF min9.8W max35W 350mA
026.219	DRIVER DIM PUSH/0-10V/DALI 16.1W 350mA
026.187	DRIVER DIM 0-10V 35W 350mA
026.185	DRIVER DIM PUSH/DALI 35W 350mA

#### ACCESSORI / ACCESSORIES

023.414	Controcassa per muratura / Housing box for brickwork / Einbaugehäuse für Betonwand / Boîtier pour béton/briques [185x205x105mm]
099.142	Pg.415 Kit emergenza / Emergency Kit

#### DATI TECNICI / TECHNICAL DATA

4054-3003	LED 21W-24Vdc-2500lm-3000°K-CRI90
4054-2703	LED 21W-24Vdc-2400lm-2700°K-CRI90
4054-4003	LED 21W-24Vdc-2600lm-4000°K-CRI90
026.259	DRIVER ON/OFF 36W 24V
026.260	DRIVER ON/OFF 60W 24V
026.261	DRIVER ON/OFF 150W 24V
026.262	DRIVER ON/OFF 240W 24V
026.219	DRIVER DIM PUSH/0-10V/DALI 21.6W 24V
026.209	DRIVER DIM PUSH/1-10V 60W 24V
026.190+026.261	DRIVER DIM PUSH/0-10V/DALI 150W 24V
026.190+026.262	DRIVER DIM PUSH/0-10V/DALI 240W 24V

#### ACCESSORI / ACCESSORIES

023.415	Controcassa per muratura / Housing box for brickwork / Einbaugehäuse für Betonwand / Boîtier pour béton/briques [485x185x115mm]
099.142	Pg.415 Kit emergenza / Emergency Kit

4052

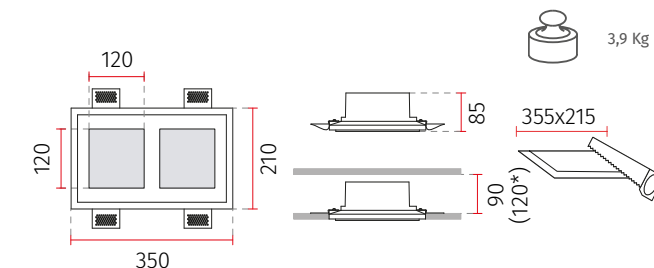

3,9 Kg

\*= Misura con alimentatore in controsoffitto / Measure with driver in counterceiling / Abmessung mit Betriebsgerät in der Zwischendecke / Mesure avec alimentation en contre-plafond

4053



1,65 Kg

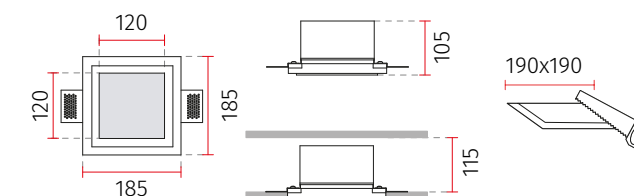

4054



3,4 Kg

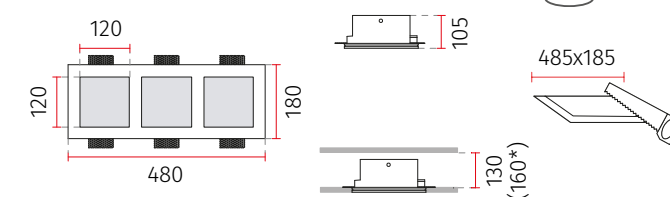

\*= Misura con alimentatore in controsoffitto / Measure with driver in counterceiling / Abmessung mit Betriebsgerät in der Zwischendecke / Mesure avec alimentation en contre-plafond

IT Misure espresse in mm, tolleranza +/- 1-2 mm. L'azienda si riserva la facoltà di apportare variazioni di dati caratteristici, materiali, design, stili, tonalità, senza alcun preavviso.  
EN Measures in mm, tolerance +/- 1/2 mm. The company reserves the right to carry out variations to technical details, materials, design, style, colors with no previous notice.

DE Die Maße sind in mm, mit einer Tolleranz von +/- 1-2 mm ausgedrückt. Die Firma behält sich das Recht vor ohne Voranmeldung Änderungen an den Werkstoffen, am Design, am Stil und an der Färbung vorzunehmen.  
FR Mesures en mm, tolérance +/- 1/2 mm. La société se réserve le droit de modifier sans préavis les détails techniques, les matériaux, le design, le style et les couleurs.





# INCASSO A PLAFONE E A PARETE

## Ceiling and wall recessed lighting

### Wand- und Decken-Einbauleuchten

### Encastrés Muraux et Plafonds

CRISTALY®

made in Italy

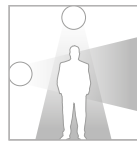

Art. 4176 - Private house - Bergamo, Italy



DATI TECNICI / TECHNICAL DATA	
4174-35	GU10 Ø50 MAX 35W-240V
ACCESSORI / ACCESSORIES	
023.416	Controcassa per muratura / Housing box for brickwork / Einbaugehäuse für Betonwand / Boîtier pour béton/briques [155x155x130mm]
L001-3018	LED 8W-220-240V-650lm-3000°K-CRI85-60°
L002-3020	LED 12W-220-240V-1000lm-3000°K-CRI85-60°
L004-3018	LED 8W-220-240V-650lm-3000°K-CRI85-30°
L005-3020	LED 12W-220-240V-1000lm-3000°K-CRI85-30°
021.231	Portalamпада / Lampholder / Lampenfassung / Source GU5.3

\*= Altezza inclusa lampadina OSRAM GU10 H52 mm e portalamпада / height including OSRAM GU10 H52 mm lamp and lampholder / Höhe inkl. OSRAM GU10 H52mm Lampe und Fassung / Hauteur compris ampoule OSRAM GU10 H52mm et source

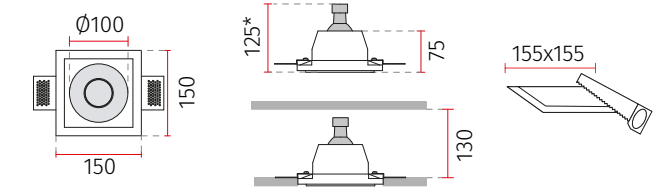

DATI TECNICI / TECHNICAL DATA	
4175-35	GU10 Ø50 MAX 35W-240V
ACCESSORI / ACCESSORIES	
023.448	Controcassa per muratura / Housing box for brickwork / Einbaugehäuse für Betonwand / Boîtier pour béton/briques [190x190x125mm]
L001-3018	LED 8W-220-240V-650lm-3000°K-CRI85-60°
L002-3020	LED 12W-220-240V-1000lm-3000°K-CRI85-60°
L004-3018	LED 8W-220-240V-650lm-3000°K-CRI85-30°
L005-3020	LED 12W-220-240V-1000lm-3000°K-CRI85-30°
021.231	Portalamпада / Lampholder / Lampenfassung / Source GU5.3

\*= Altezza inclusa lampadina OSRAM GU10 H52 mm e portalamпада / height including OSRAM GU10 H52 mm lamp and lampholder / Höhe inkl. OSRAM GU10 H52mm Lampe und Fassung / Hauteur compris ampoule OSRAM GU10 H52mm et source

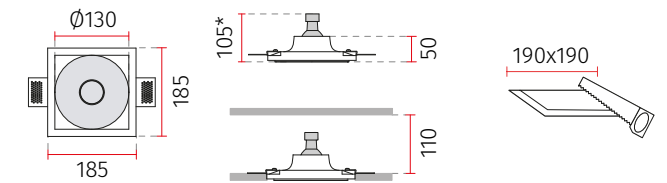

DATI TECNICI / TECHNICAL DATA	
4176-35	GU10 Ø50 MAX 35W-240V
ACCESSORI / ACCESSORIES	
023.402	Controcassa per muratura / Housing box for brickwork / Einbaugehäuse für Betonwand / Boîtier pour béton/briques [125x125x130mm]
L001-3018	LED 8W-220-240V-650lm-3000°K-CRI85-60°
L002-3020	LED 12W-220-240V-1000lm-3000°K-CRI85-60°
L004-3018	LED 8W-220-240V-650lm-3000°K-CRI85-30°
L005-3020	LED 12W-220-240V-1000lm-3000°K-CRI85-30°
021.231	Portalamпада / Lampholder / Lampenfassung / Source GU5.3

\*= Altezza inclusa lampadina OSRAM GU10 H52 mm e portalamпада / height including OSRAM GU10 H52 mm lamp and lampholder / Höhe inkl. OSRAM GU10 H52mm Lampe und Fassung / Hauteur compris ampoule OSRAM GU10 H52mm et source

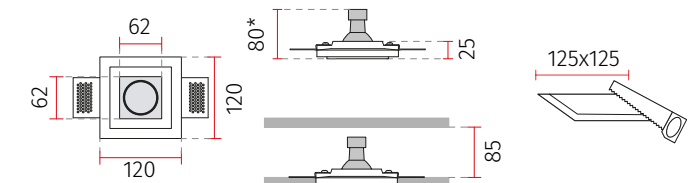

IT Misure espresse in mm, tolleranza +/- 1-2 mm. L'azienda si riserva la facoltà di apportare variazioni di dati caratteristici, materiali, design, stili, tonalità, senza alcun preavviso.  
EN Measures in mm, tolerance +/- 1/2 mm. The company reserves the right to carry out variations to technical details, materials, design, style, colors with no previous notice.

DE Die Masse sind in mm, mit einer Tolleranz von +/- 1-2 mm ausgedrückt, Die Firma behält sich das Recht vor ohne Voranmeldung Änderungen an den Werkstoffen, am Design, am Stil und an der Färbung vorzunehmen.  
FR Mesures en mm, tolérance +/- 1/2 mm. La société se réserve le droit de modifier sans préavis les détails techniques, les matériaux, le design, le style et les couleurs.

4174



0,85 Kg

4175



1,1 Kg

4176



0,45 Kg

# INCASSO A PLAFONE E A PARETE

## Ceiling and wall recessed lighting

### Wand- und Decken-Einbauleuchten

### Encastrés Muraux et Plafonds

made in Italy

CRISTALY®

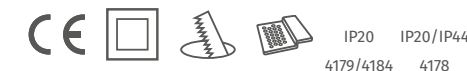
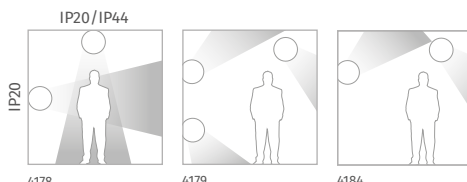

Art. 4179 - Private house - Milano, Italy



IT Misure espresse in mm, tolleranza +/- 1-2 mm. L'azienda si riserva la facoltà di apportare variazioni di dati caratteristici, materiali, design, stili, tonalità, senza alcun preavviso.  
EN Measures in mm, tolerance +/- 1/2 mm. The company reserves the right to carry out variations to technical details, materials, design, style, colors with no previous notice.

#### DATI TECNICI / TECHNICAL DATA

4178-35 GU10 Ø50 MAX 35W-240V

#### ACCESSORI / ACCESSORIES

023.416	Controcassa per muratura / Housing box for brickwork / Einbaugehäuse für Betonwand / Boîtier pour béton/briques [155x155x130mm]
L001-3018	LED 8W-220-240V-650lm-3000°K-CRI85-60°
L002-3020	LED 12W-220-240V-1000lm-3000°K-CRI85-60°
L004-3018	LED 8W-220-240V-650lm-3000°K-CRI85-30°
L005-3020	LED 12W-220-240V-1000lm-3000°K-CRI85-30°
021.231	Portalamпада / Lampholder / Lampenfassung / Source GU5.3



Diffusore in vetro  
Glass diffuser  
Glasabdeckung  
Diffuseur en verre

\*= Altezza inclusa lampadina OSRAM GU10 H52 mm e portalamпада / height including OSRAM GU10 H52 mm lamp and lampholder / Höhe inkl. OSRAM GU10 H52mm Lampe und Fassung / Hauteur compris ampoule OSRAM GU10 H52mm et source

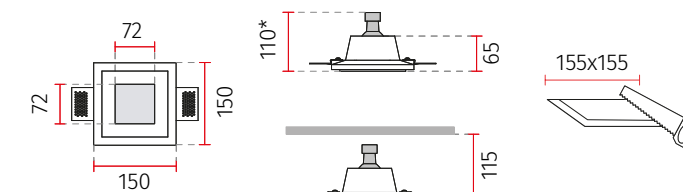

0,9 Kg

#### DATI TECNICI / TECHNICAL DATA

4179-35 GU10 Ø50 MAX 35W-240V

#### ACCESSORI / ACCESSORIES

023.416	Controcassa per muratura / Housing box for brickwork / Einbaugehäuse für Betonwand / Boîtier pour béton/briques [155x155x130mm]
L001-3018	LED 8W-220-240V-650lm-3000°K-CRI85-60°
L002-3020	LED 12W-220-240V-1000lm-3000°K-CRI85-60°
L004-3018	LED 8W-220-240V-650lm-3000°K-CRI85-30°
L005-3020	LED 12W-220-240V-1000lm-3000°K-CRI85-30°
021.231	Portalamпада / Lampholder / Lampenfassung / Source GU5.3

\*= Altezza inclusa lampadina OSRAM GU10 H52 mm e portalamпада / height including OSRAM GU10 H52 mm lamp and lampholder / Höhe inkl. OSRAM GU10 H52mm Lampe und Fassung / Hauteur compris ampoule OSRAM GU10 H52mm et source

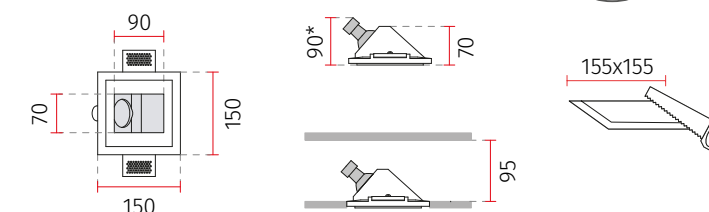

0,85 Kg

#### DATI TECNICI / TECHNICAL DATA

4184-35 GU10 Ø50 MAX 10W-240V

#### ACCESSORI / ACCESSORIES

023.449	Controcassa per muratura / Housing box for brickwork / Einbaugehäuse für Betonwand / Boîtier pour béton/briques [195x165x50mm]
L001-3018	LED 8W-220-240V-650lm-3000°K-CRI85-60°
L002-3020	LED 12W-220-240V-1000lm-3000°K-CRI85-60°
L004-3018	LED 8W-220-240V-650lm-3000°K-CRI85-30°
L005-3020	LED 12W-220-240V-1000lm-3000°K-CRI85-30°
021.231	Portalamпада / Lampholder / Lampenfassung / Source GU5.3

Inclinazione lampadina  
Bulb inclination  
Neigung des Leuchtmittels  
Inclinaison de l'ampoule

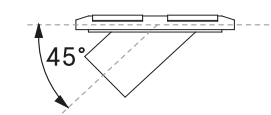

DE Die Masse sind in mm, mit einer Tolleranz von +/- 1-2 mm ausgedrückt, Die Firma behält sich das Recht vor ohne Voranmeldung Änderungen an den Werkstoffen, am Design, am Stil und an der Färbung vorzunehmen.  
FR Mesures en mm, tolérance +/- 1/2 mm. La société se réserve le droit de modifier sans préavis les détails techniques, les matériaux, le design, le style et les couleurs.

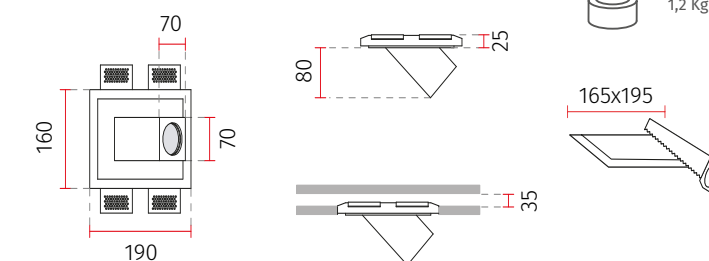

1,2 Kg

4178

4179

4184



# INCASSO A PLAFONE E A PARETE

Ceiling and wall recessed lighting  
Wand- und Decken-Einbauleuchten  
Encastrés Muraux et Plafonds

CRISTALY®

made in Italy

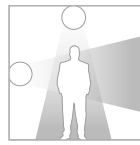

Art. 4180 / P004 - Private house - Roma, Italy  
Arch. Antonio Matarrese



## DATI TECNICI / TECHNICAL DATA

4180-35 GU10 ø50 MAX 35W-240V

## ACCESSORI / ACCESSORIES

023.416	Controcassa per muratura / Housing box for brickwork / Einbaugehäuse für Betonwand / Boîtier pour béton/briques [155x155x130mm]
L001-3018	LED 8W-220-240V-650lm-3000°K-CRI85-60°
L002-3020	LED 12W-220-240V-1000lm-3000°K-CRI85-60°
L004-3018	LED 8W-220-240V-650lm-3000°K-CRI85-30°
L005-3020	LED 12W-220-240V-1000lm-3000°K-CRI85-30°
021.231	Portalamпада / Lampholder / Lampenfassung / Source GU5.3

\*= Altezza inclusa lampadina OSRAM GU10 H52 mm e portalamпада / height including OSRAM GU10 H52 mm lamp and lampholder / Höhe inkl. OSRAM GU10 H52mm Lampe und Fassung / Hauteur compris ampoule OSRAM GU10 H52mm et source

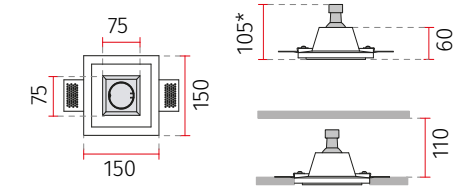

4180



0,75 Kg

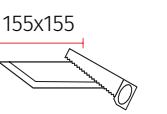

## DATI TECNICI / TECHNICAL DATA

4180A-35 GU10 ø50 MAX 2x35W-240V

## ACCESSORI / ACCESSORIES

023.456	Controcassa per muratura / Housing box for brickwork / Einbaugehäuse für Betonwand / Boîtier pour béton/briques [235x155x115mm]
L001-3018	LED 8W-220-240V-650lm-3000°K-CRI85-60°
L002-3020	LED 12W-220-240V-1000lm-3000°K-CRI85-60°
L004-3018	LED 8W-220-240V-650lm-3000°K-CRI85-30°
L005-3020	LED 12W-220-240V-1000lm-3000°K-CRI85-30°
021.231	Portalamпада / Lampholder / Lampenfassung / Source GU5.3

\*= Altezza inclusa lampadina OSRAM GU10 H52 mm e portalamпада / height including OSRAM GU10 H52 mm lamp and lampholder / Höhe inkl. OSRAM GU10 H52mm Lampe und Fassung / Hauteur compris ampoule OSRAM GU10 H52mm et source

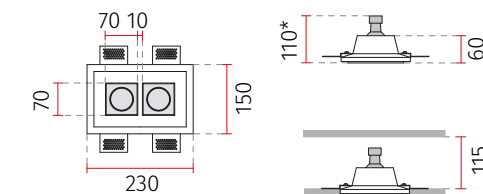

4180A



1,5 Kg

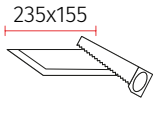

## DATI TECNICI / TECHNICAL DATA

4180B-35 GU10 ø50 MAX 2x35W-240V

## ACCESSORI / ACCESSORIES

023.457	Controcassa per muratura / Housing box for brickwork / Einbaugehäuse für Betonwand / Boîtier pour béton/briques [295x155x115mm]
L001-3018	LED 8W-220-240V-650lm-3000°K-CRI85-60°
L002-3020	LED 12W-220-240V-1000lm-3000°K-CRI85-60°
L004-3018	LED 8W-220-240V-650lm-3000°K-CRI85-30°
L005-3020	LED 12W-220-240V-1000lm-3000°K-CRI85-30°
021.231	Portalamпада / Lampholder / Lampenfassung / Source GU5.3

\*= Altezza inclusa lampadina OSRAM GU10 H52 mm e portalamпада / height including OSRAM GU10 H52 mm lamp and lampholder / Höhe inkl. OSRAM GU10 H52mm Lampe und Fassung / Hauteur compris ampoule OSRAM GU10 H52mm et source

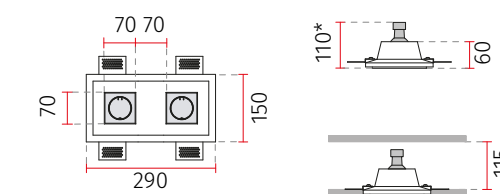

4180B



1,7 Kg

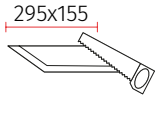

IT Misure espresse in mm, tolleranza +/- 1-2 mm. L'azienda si riserva la facoltà di apportare variazioni di dati caratteristici, materiali, design, stili, tonalità, senza alcun preavviso.  
EN Measures in mm, tolerance +/- 1/2 mm. The company reserves the right to carry out variations to technical details, materials, design, style, colors with no previous notice.

DE Die Masse sind in mm, mit einer Tolleranz von +/- 1-2 mm ausgedrückt, Die Firma behält sich das Recht vor ohne Voranmeldung Änderungen an den Werkstoffen, am Design, am Stil und an der Färbung vorzunehmen.  
FR Mesures en mm, tolérance +/- 1/2 mm. La société se réserve le droit de modifier sans préavis les détails techniques, les matériaux, le design, le style et les couleurs.

# INCASSO A PLAFONE E A PARETE

## Ceiling and wall recessed lighting

### Wand- und Decken-Einbauleuchten

### Encastrés Muraux et Plafonds

CRISTALY®

made in Italy

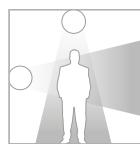

Art. 4183 - Private house - Cosenza, Italy



IT Misure espresse in mm, tolleranza +/- 1-2 mm. L'azienda si riserva la facoltà di apportare variazioni di dati caratteristici, materiali, design, stili, tonalità, senza alcun preavviso.  
EN Measures in mm, tolerance +/- 1/2 mm. The company reserves the right to carry out variations to technical details, materials, design, style, colors with no previous notice.

#### DATI TECNICI / TECHNICAL DATA

4181-35 GU10 Ø50 MAX 35W-240V

#### ACCESSORI / ACCESSORIES

023.402	Controcassa per muratura / Housing box for brickwork / Einbaugehäuse für Betonwand / Boîtier pour béton/briques [125x125x130mm]
L001-3018	LED 8W-220-240V-650lm-3000°K-CRI85-60°
L002-3020	LED 12W-220-240V-1000lm-3000°K-CRI85-60°
L004-3018	LED 8W-220-240V-650lm-3000°K-CRI85-30°
L005-3020	LED 12W-220-240V-1000lm-3000°K-CRI85-30°
021.231	Portalamпада / Lampholder / Lampenfassung / Source GU5.3

\*= Altezza inclusa lampadina OSRAM GU10 H52 mm e portalamпада / height including OSRAM GU10 H52 mm lamp and lampholder / Höhe inkl. OSRAM GU10 H52mm Lampe und Fassung / Hauteur compris ampoule OSRAM GU10 H52mm et source

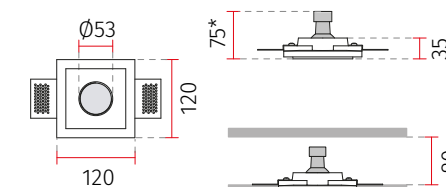

0,45 Kg

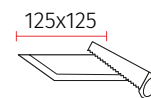

125x125

# 4183

#### DATI TECNICI / TECHNICAL DATA

4183-35 GU10 Ø50 MAX 35W-240V

#### ACCESSORI / ACCESSORIES

023.448	Controcassa per muratura / Housing box for brickwork / Einbaugehäuse für Betonwand / Boîtier pour béton/briques [190x190x125mm]
021.231	Portalamпада / Lampholder / Lampenfassung / Source GU5.3

Lampadina orientabile di 30°  
Adjustable spotlight 30°  
Schwenkbares Leuchtmittel 30°  
Ampoule pivotante 30°



\*= Altezza inclusa lampadina OSRAM GU10 H52 mm e portalamпада / height including OSRAM GU10 H52 mm lamp and lampholder / Höhe inkl. OSRAM GU10 H52mm Lampe und Fassung / Hauteur compris ampoule OSRAM GU10 H52mm et source

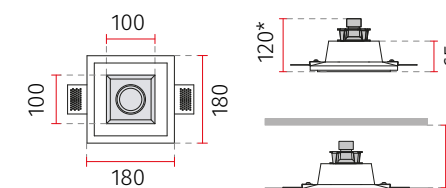

1,15 Kg

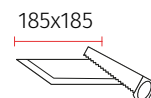

185x185

#### DATI TECNICI / TECHNICAL DATA

4210-35 GU10 Ø50 MAX 2x35W-240V

#### ACCESSORI / ACCESSORIES

023.458	Controcassa per muratura / Housing box for brickwork / Einbaugehäuse für Betonwand / Boîtier pour béton/briques [290x180x120mm]
L001-3018	LED 8W-220-240V-650lm-3000°K-CRI85-60°
L002-3020	LED 12W-220-240V-1000lm-3000°K-CRI85-60°
L004-3018	LED 8W-220-240V-650lm-3000°K-CRI85-30°
L005-3020	LED 12W-220-240V-1000lm-3000°K-CRI85-30°
021.231	Portalamпада / Lampholder / Lampenfassung / Source GU5.3

\*= Altezza inclusa lampadina OSRAM GU10 H52 mm e portalamпада / height including OSRAM GU10 H52 mm lamp and lampholder / Höhe inkl. OSRAM GU10 H52mm Lampe und Fassung / Hauteur compris ampoule OSRAM GU10 H52mm et source

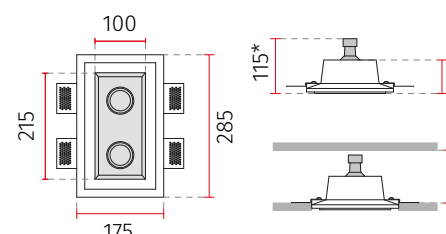

1,9 Kg

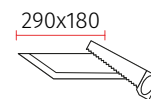

290x180

DE Die Masse sind in mm, mit einer Tolleranz von +/- 1-2 mm ausgedrückt, Die Firma behält sich das Recht vor ohne Voranmeldung Änderungen an den Werkstoffen, am Design, am Stil und an der Färbung vorzunehmen.  
FR Mesures en mm, tolérance +/- 1/2 mm. La société se réserve le droit de modifier sans préavis les détails techniques, les matériaux, le design, le style et les couleurs.

# INCASSO A PLAFONE E A PARETE

## Ceiling and wall recessed lighting

### Wand- und Decken-Einbauleuchten

### Encastrés Muraux et Plafonds

CRISTALY®

made in Italy

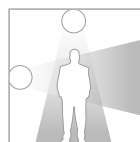

Art. 4215 - Private house - Bari, Italy  
Arch. Paolo Tari e Gianpiero Conserva

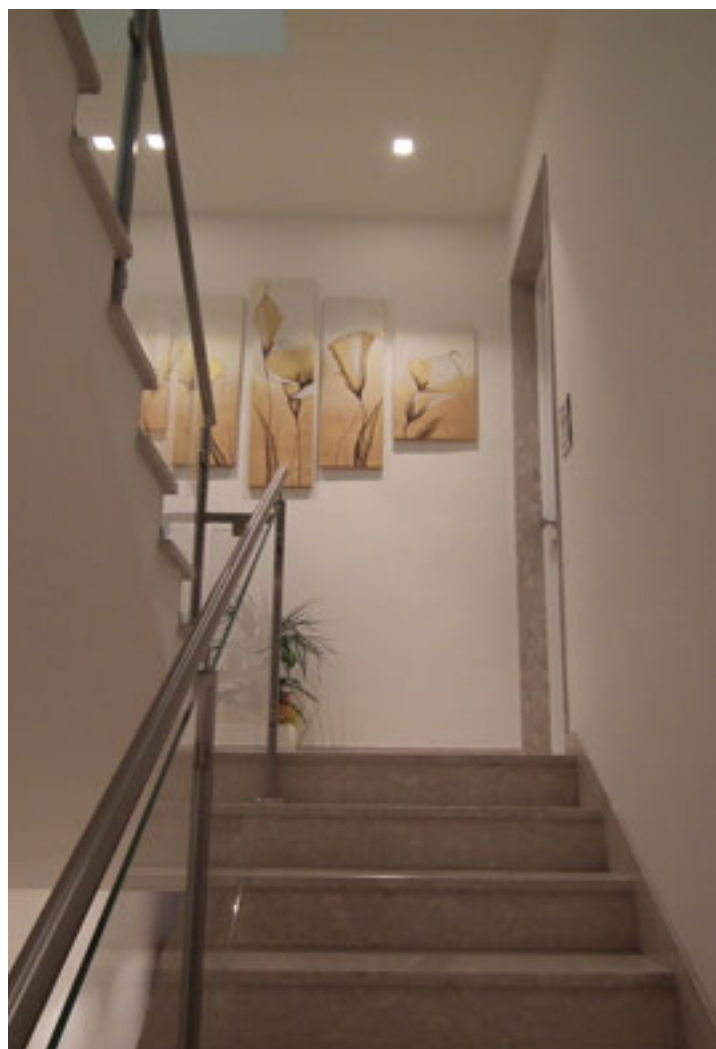
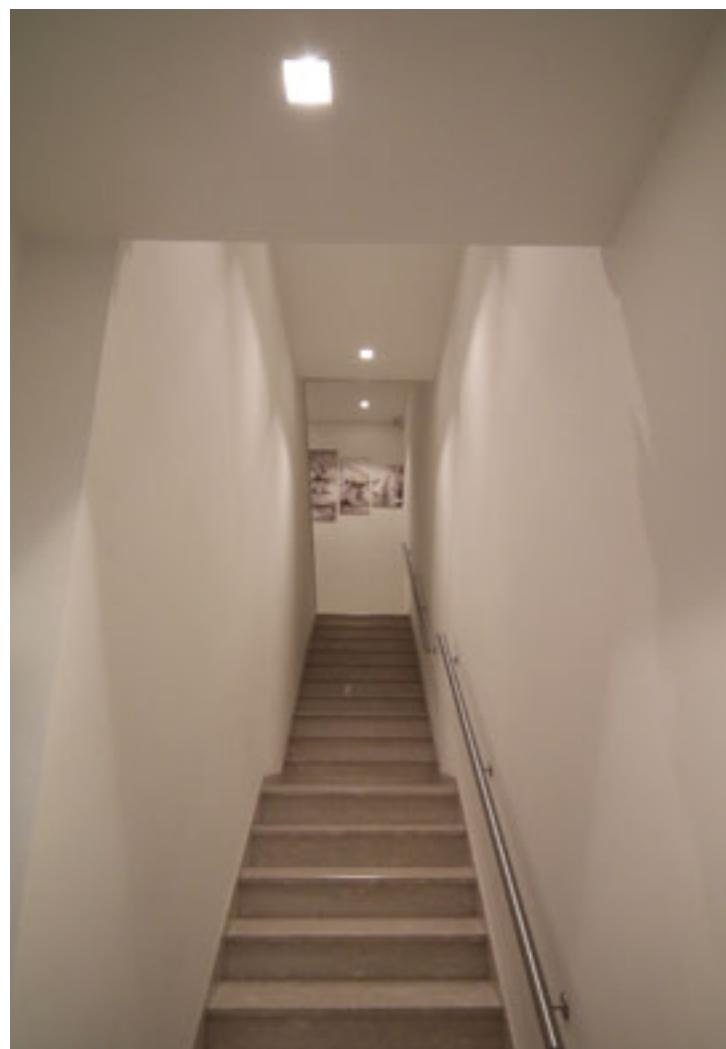

DATI TECNICI / TECHNICAL DATA	
4215-35	GU10 Ø50 MAX 35W-240V
ACCESSORI / ACCESSORIES	
023.447	Controcassa per muratura / Housing box for brickwork / Einbaugehäuse für Betonwand / Boîtier pour béton/briques [200x200x120mm]
021.231	Portalampada / Lampholder / Lampenfassung / Source GU5.3

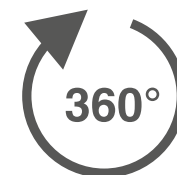

Lampadina orientabile in tutte le direzioni di 30°  
Adjustable spotlight in all directions 30°  
Schwenkbares Leuchtmittel in alle Richtungen 30°  
Ampoule pivotante dans toutes les directions 30°

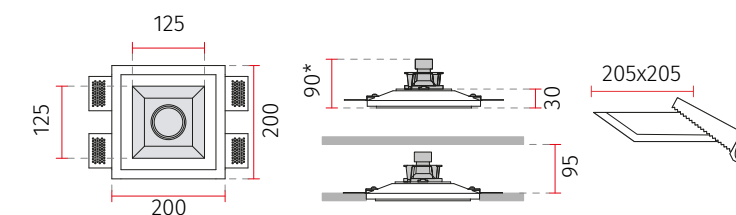

4215



1,2 Kg

\*= Altezza inclusa lampadina OSRAM GU10 H52 mm e portalampada / height including OSRAM GU10 H52 mm lamp and lampholder / Höhe inkl. OSRAM GU10 H52mm Lampe und Fassung / Hauteur compris ampoule OSRAM GU10 H52mm et source

DATI TECNICI / TECHNICAL DATA	
4216-35	GU10 Ø50 MAX 35W-240V
ACCESSORI / ACCESSORIES	
023.447	Controcassa per muratura / Housing box for brickwork / Einbaugehäuse für Betonwand / Boîtier pour béton/briques [200x200x120mm]
021.231	Portalampada / Lampholder / Lampenfassung / Source GU5.3

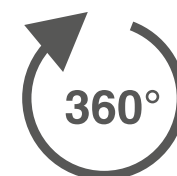

Lampadina orientabile in tutte le direzioni di 30°  
Adjustable spotlight in all directions 30°  
Schwenkbares Leuchtmittel in alle Richtungen 30°  
Ampoule pivotante dans toutes les directions 30°

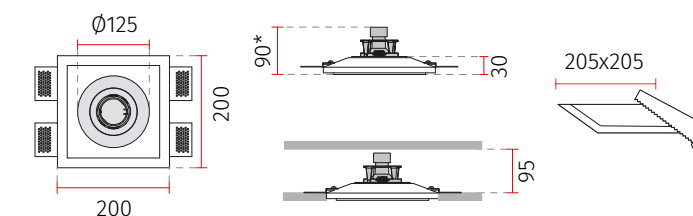

4216



1,3 Kg

\*= Altezza inclusa lampadina OSRAM GU10 H52 mm e portalampada / height including OSRAM GU10 H52 mm lamp and lampholder / Höhe inkl. OSRAM GU10 H52mm Lampe und Fassung / Hauteur compris ampoule OSRAM GU10 H52mm et source

IT Misure espresse in mm, tolleranza +/- 1-2 mm. L'azienda si riserva la facoltà di apportare variazioni di dati caratteristici, materiali, design, stili, tonalità, senza alcun preavviso.  
EN Measures in mm, tolerance +/- 1/2 mm. The company reserves the right to carry out variations to technical details, materials, design, style, colors with no previous notice.

DE Die Masse sind in mm, mit einer Tolleranz von +/- 1-2 mm ausgedrückt, Die Firma behält sich das Recht vor ohne Voranmeldung Änderungen an den Werkstoffen, am Design, am Stil und an der Färbung vorzunehmen.  
FR Mesures en mm, tolérance +/- 1/2 mm. La société se réserve le droit de modifier sans préavis les détails techniques, les matériaux, le design, le style et les couleurs.

# INCASSO A PLAFONE E A PARETE

Ceiling and wall recessed lighting  
Wand- und Decken-Einbauleuchten  
Encastrés Muraux et Plafonds

CRISTALY®

made in Italy

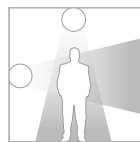

Art. 4218 - Private house - Foggia, Italy

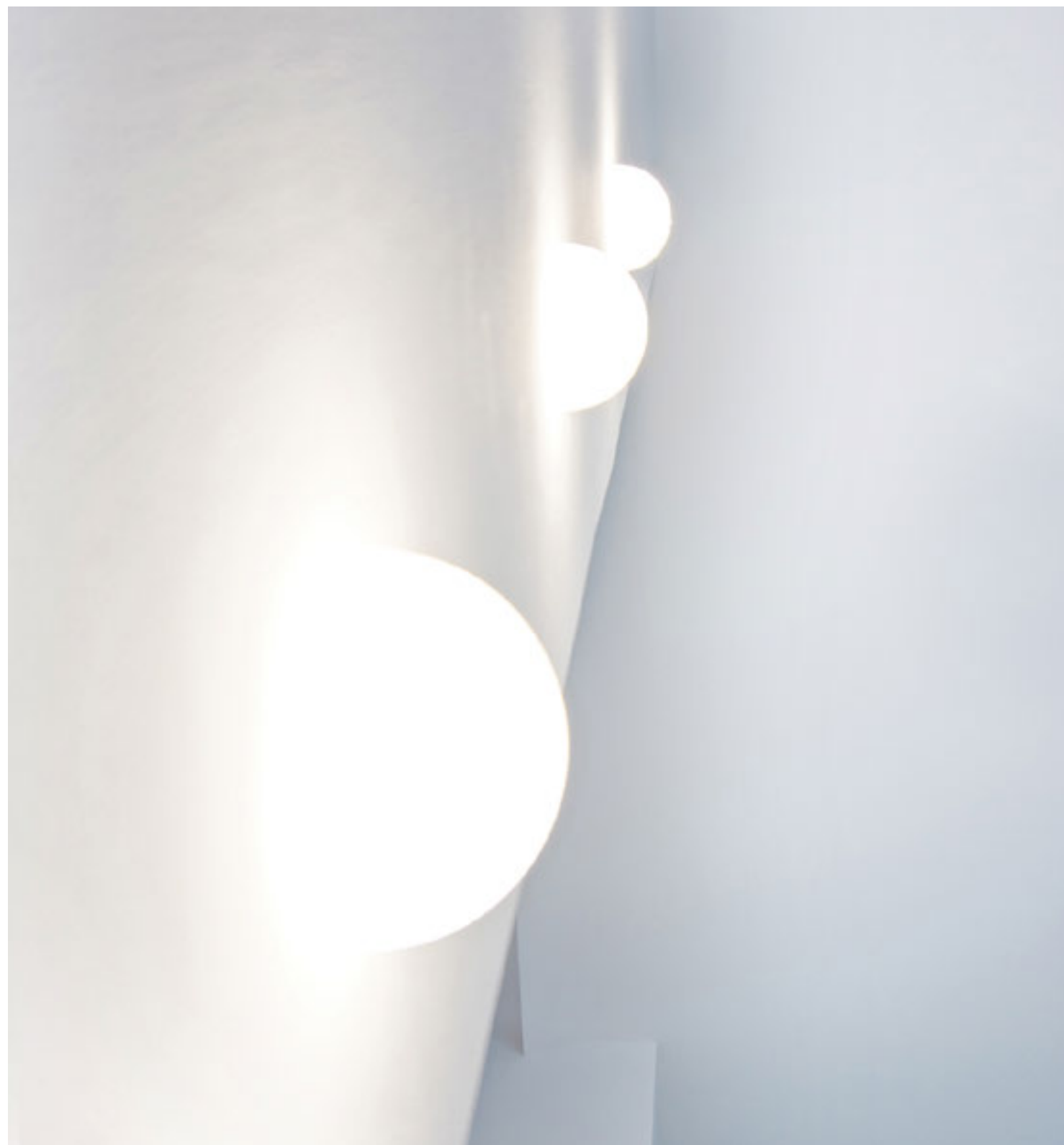

## DATI TECNICI / TECHNICAL DATA

4218-39 E27 MAX 20W-240V

## ACCESSORI / ACCESSORIES

023.416 Controcassa per muratura / Housing box for brickwork / Einbaugehäuse für Betonwand / Boîtier pour béton/briques [155x155x130mm]

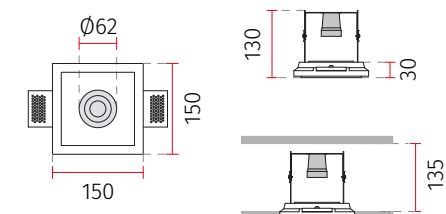

# 4218

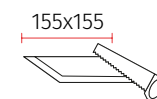

## DATI TECNICI / TECHNICAL DATA

4218A-39 E27 MAX 20W-240V

## ACCESSORI / ACCESSORIES

023.416 Controcassa per muratura / Housing box for brickwork / Einbaugehäuse für Betonwand / Boîtier pour béton/briques [155x155x130mm]

Dettaglio lampadina 4218A  
Bulb detail for 4218A  
Detail Leuchtmittel 4218A  
Détail ampoule 4218A

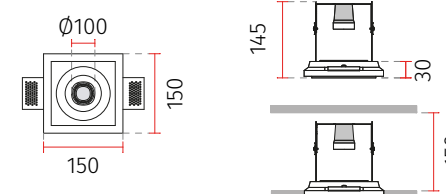
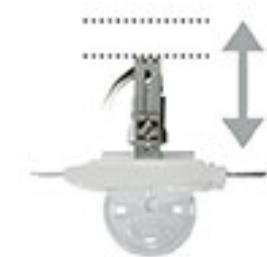

# 4218A

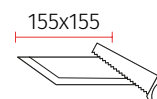

## DATI TECNICI / TECHNICAL DATA

4219-39 E27 MAX 20W-240V

## ACCESSORI / ACCESSORIES

023.416 Controcassa per muratura / Housing box for brickwork / Einbaugehäuse für Betonwand / Boîtier pour béton/briques [155x155x130mm]

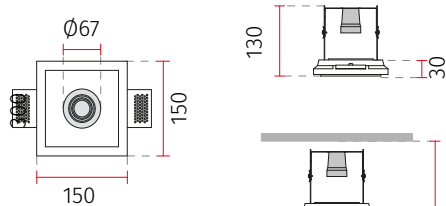

# 4219

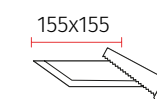

IT Misure espresse in mm, tolleranza +/- 1-2 mm. L'azienda si riserva la facoltà di apportare variazioni di dati caratteristici, materiali, design, stili, tonalità, senza alcun preavviso.  
EN Measures in mm, tolerance +/- 1/2 mm. The company reserves the right to carry out variations to technical details, materials, design, style, colors with no previous notice.

DE Die Masse sind in mm, mit einer Tolleranz von +/- 1-2 mm ausgedrückt, Die Firma behält sich das Recht vor ohne Voranmeldung Änderungen an den Werkstoffen, am Design, am Stil und an der Färbung vorzunehmen.  
FR Mesures en mm, tolérance +/- 1/2 mm. La société se réserve le droit de modifier sans préavis les détails techniques, les matériaux, le design, le style et les couleurs.



# INCASSO A PLAFONE E A PARETE

Ceiling and wall recessed lighting  
Wand- und Decken-Einbauleuchten  
Encastrés Muraux et Plafonds

CRISTALY®

made in Italy

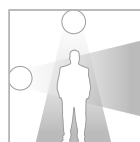

## DATI TECNICI / TECHNICAL DATA

4275-35 GU10 Ø35 MAX 20W-240V

## ACCESSORI / ACCESSORIES

023.451	Controcassa per muratura / Housing box for brickwork / Einbaugehäuse für Betonwand / Boîtier pour béton/briques [125x125x100mm]
L007	LED GU10 Ø35mm LED 3.2W-220-240V
021.226	Portalampada / Lampholder / Lampenfassung / Source GU4

4275



0,6 Kg

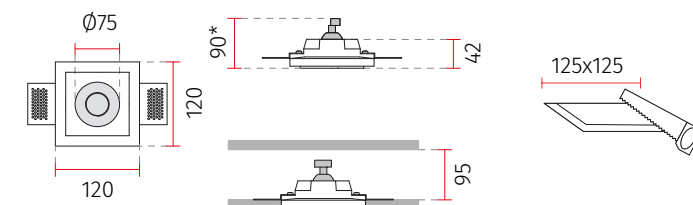

\*= Altezza inclusa lampadina 9010 GU10 H45 mm e portalampada / height including 9010 GU10 H45 mm lamp and lampholder / Höhe inkl. 9010 GU10 H45 mm Lampe und Fassung / Hauteur compris ampoule 9010 GU10 H45 mm et source

Art. 4276 - Private house - Aosta, Italy



## DATI TECNICI / TECHNICAL DATA

4276-35 GU10 Ø35 MAX 20W-240V

## ACCESSORI / ACCESSORIES

023.451	Controcassa per muratura / Housing box for brickwork / Einbaugehäuse für Betonwand / Boîtier pour béton/briques [125x125x100mm]
L007	LED GU10 Ø35mm LED 3.2W-220-240V
021.226	Portalampada / Lampholder / Lampenfassung / Source GU4

4276



0,55 Kg

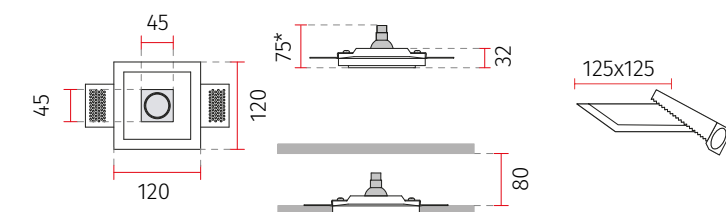

\*= Altezza inclusa lampadina 9010 GU10 H45 mm e portalampada / height including 9010 GU10 H45 mm lamp and lampholder / Höhe inkl. 9010 GU10 H45 mm Lampe und Fassung / Hauteur compris ampoule 9010 GU10 H45 mm et source

IT Misure espresse in mm, tolleranza +/- 1-2 mm. L'azienda si riserva la facoltà di apportare variazioni di dati caratteristici, materiali, design, stili, tonalità, senza alcun preavviso.  
EN Measures in mm, tolerance +/- 1/2 mm. The company reserves the right to carry out variations to technical details, materials, design, style, colors with no previous notice.

DE Die Masse sind in mm, mit einer Tolleranz von +/- 1-2 mm ausgedrückt, Die Firma behält sich das Recht vor ohne Voranmeldung Änderungen an den Werkstoffen, am Design, am Stil und an der Färbung vorzunehmen.  
FR Mesures en mm, tolérance +/- 1/2 mm. La société se réserve le droit de modifier sans préavis les détails techniques, les matériaux, le design, le style et les couleurs.

# INCASSO A PLAFONE E A PARETE

## Ceiling and wall recessed lighting

### Wand- und Decken-Einbauleuchten

### Encastrés Muraux et Plafonds

CRISTALY®

made in Italy

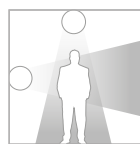

Art. 4278 - Private house - Bari, Italy



Art. 4277 - Private house - Como, Italy



#### DATI TECNICI / TECHNICAL DATA

4277-35 GU10 Ø35 MAX 20W-240V

#### ACCESSORI / ACCESSORIES

- 023.451 Controcassa per muratura / Housing box for brickwork / Einbaugehäuse für Betonwand / Boîtier pour béton/briques [125x125x100mm]
- L007 LED GU10 Ø35mm LED 3.2W-220-240V
- 021.226 Portalamпада / Lampholder / Lampenfassung / Source GU4

4277



0,6 Kg

Diffusore in vetro  
Glass diffuser  
Glasabdeckung  
Diffuseur en verre

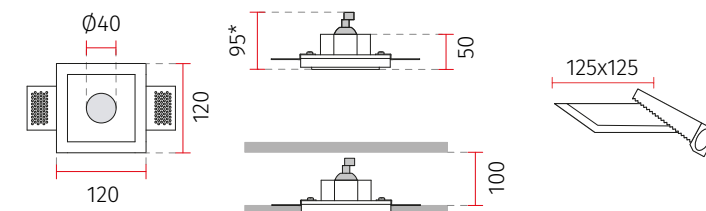
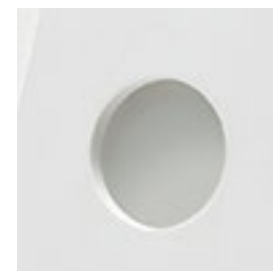

\*= Altezza inclusa lampadina 9010 GU10 H45 mm e portalamпада / height including 9010 GU10 H45 mm lamp and lampholder / Höhe inkl. 9010 GU10 H45 mm Lampe und Fassung / Hauteur compris ampoule 9010 GU10 H45 mm et source

#### DATI TECNICI / TECHNICAL DATA

4278-35 GU10 Ø35 MAX 20W-240V

#### ACCESSORI / ACCESSORIES

- 023.451 Controcassa per muratura / Housing box for brickwork / Einbaugehäuse für Betonwand / Boîtier pour béton/briques [125x125x100mm]
- L007 LED GU10 Ø35mm LED 3.2W-220-240V
- 021.226 Portalamпада / Lampholder / Lampenfassung / Source GU4

4278



0,6 Kg

Diffusore in vetro  
Glass diffuser  
Glasabdeckung  
Diffuseur en verre

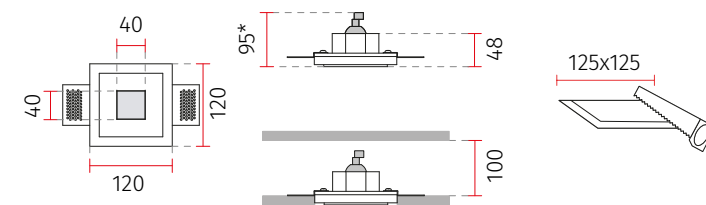

\*= Altezza inclusa lampadina 9010 GU10 H45 mm e portalamпада / height including 9010 GU10 H45 mm lamp and lampholder / Höhe inkl. 9010 GU10 H45 mm Lampe und Fassung / Hauteur compris ampoule 9010 GU10 H45 mm et source

IT Misure espresse in mm, tolleranza +/- 1-2 mm. L'azienda si riserva la facoltà di apportare variazioni di dati caratteristici, materiali, design, stili, tonalità, senza alcun preavviso.  
EN Measures in mm, tolerance +/- 1/2 mm. The company reserves the right to carry out variations to technical details, materials, design, style, colors with no previous notice.

DE Die Masse sind in mm, mit einer Tolleranz von +/- 1-2 mm ausgedrückt, Die Firma behält sich das Recht vor ohne Voranmeldung Änderungen an den Werkstoffen, am Design, am Stil und an der Färbung vorzunehmen.  
FR Mesures en mm, tolérance +/- 1/2 mm. La société se réserve le droit de modifier sans préavis les détails techniques, les matériaux, le design, le style et les couleurs.

# INCASSO A PLAFONE E A PARETE

## Ceiling and wall recessed lighting

### Wand- und Decken-Einbauleuchten

### Encastrés Muraux et Plafonds

CRISTALY®

made in Italy

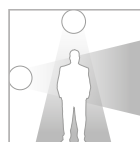

Art. 4280 - Private house - Brescia, Italy



#### DATI TECNICI / TECHNICAL DATA

4280-35 GU10 Ø35 MAX 20W-240V

#### ACCESSORI / ACCESSORIES

023.451	Controcassa per muratura / Housing box for brickwork / Einbaugehäuse für Betonwand / Boîtier pour béton/briques [125x125x100mm]
L007	LED GU10 Ø35mm LED 3.2W-220-240V
021.226	Portalamпада / Lampholder / Lampenfassung / Source GU4



# 4280



0,55 Kg

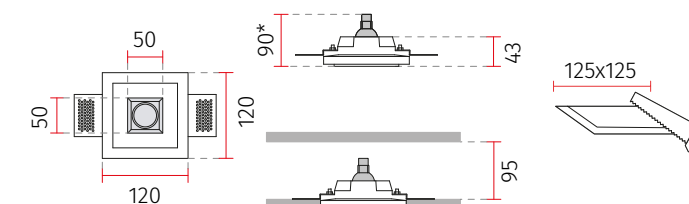

\*= Altezza inclusa lampadina 9010 GU10 H45 mm e portalamпада / height including 9010 GU10 H45 mm lamp and lampholder / Höhe inkl. 9010 GU10 H45 mm Lampe und Fassung / Hauteur compris ampoule 9010 GU10 H45 mm et source

#### DATI TECNICI / TECHNICAL DATA

4281-35 GU10 Ø35 MAX 20W-240V

#### ACCESSORI / ACCESSORIES

023.451	Controcassa per muratura / Housing box for brickwork / Einbaugehäuse für Betonwand / Boîtier pour béton/briques [125x125x100mm]
L007	LED GU10 Ø35mm LED 3.2W-220-240V
021.226	Portalamпада / Lampholder / Lampenfassung / Source GU4

# 4281



0,55 Kg

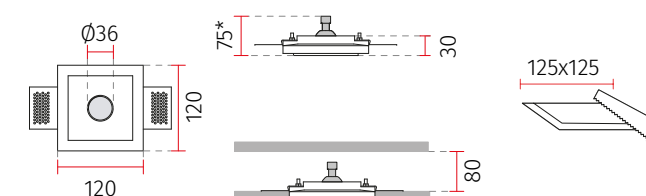

\*= Altezza inclusa lampadina 9010 GU10 H45 mm e portalamпада / height including 9010 GU10 H45 mm lamp and lampholder / Höhe inkl. 9010 GU10 H45 mm Lampe und Fassung / Hauteur compris ampoule 9010 GU10 H45 mm et source

IT Misure espresse in mm, tolleranza +/- 1-2 mm. L'azienda si riserva la facoltà di apportare variazioni di dati caratteristici, materiali, design, stili, tonalità, senza alcun preavviso.  
EN Measures in mm, tolerance +/- 1/2 mm. The company reserves the right to carry out variations to technical details, materials, design, style, colors with no previous notice.

DE Die Masse sind in mm, mit einer Tolleranz von +/- 1-2 mm ausgedrückt, Die Firma behält sich das Recht vor ohne Voranmeldung Änderungen an den Werkstoffen, am Design, am Stil und an der Färbung vorzunehmen.  
FR Mesures en mm, tolérance +/- 1/2 mm. La société se réserve le droit de modifier sans préavis les détails techniques, les matériaux, le design, le style et les couleurs.

## A PLAFONE E A PARETE

Ceiling and Wall Lighting

Decken- und Wandbeleuchtung

Plafonniers et Appliques



2426A p.281



2426B p.281



2426C p.281



8879 p.285



8881 p.285



8882 p.285

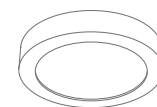

8883 p.285

# A PLAFONE E A PARETE

## Ceiling and Wall Lighting

### Decken- und Wandbeleuchtung

### Plafonniers et Appliques

KERLITE  
ALUMITE®  
made in Italy

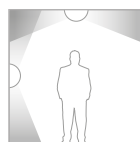

■ COLORI DEI MATERIALI / COLORS OF THE MATERIALS / FARBEN DER MATERIALIEN / COULEURS DES MATÉRIAUX



Gli articoli 2426A/B/C si possono dipingere dopo un trattamento con fondo per supporto inassorbente.

EN The articles 2426A/B/C can be painted after treatment with a promoter for non-absorbent substrates.

DE Die Artikel 2426A/B/C können nach der Behandlung mit einem Promotor für nicht absorbierende Substrate lackiert werden.

FR Les articles 2426A/B/C peuvent être peints après traitement avec un promoteur pour substrats non absorbants.

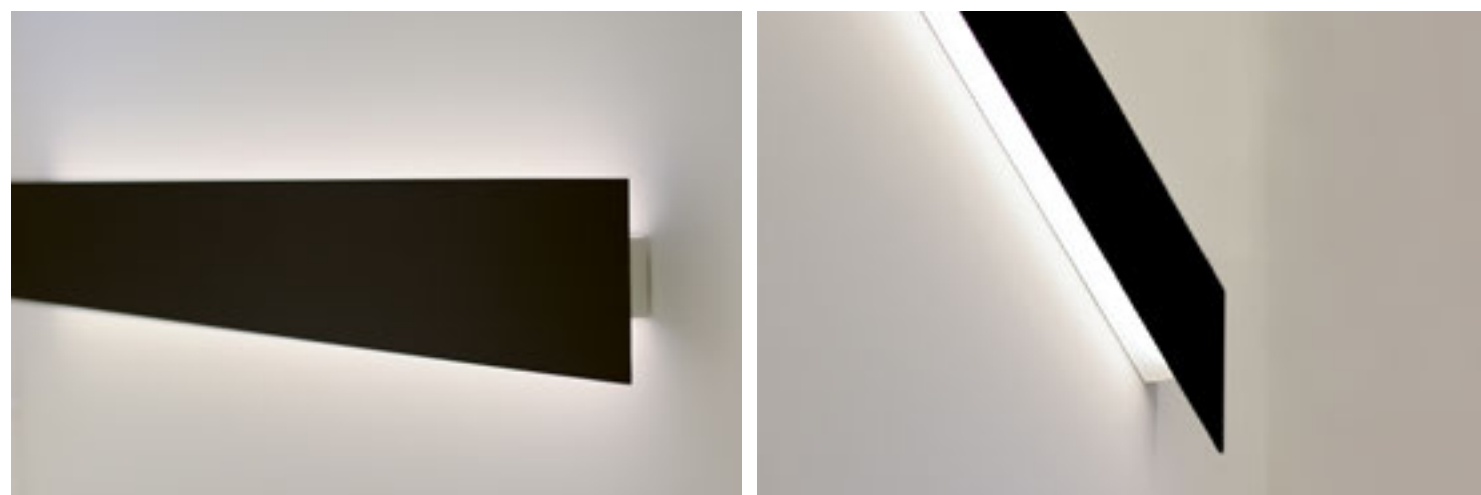

INSTALLAZIONE A SOFFITTO E A PARETE / CEILING AND WALL INSTALLATION / DECKEN- UND WANDMONTAGE / INSTALLATION AU PLAFOND ET AU MUR

INSTALLAZIONE A PARETE / WALL INSTALLATION / WANDMONTAGE / INSTALLATION AU MUR

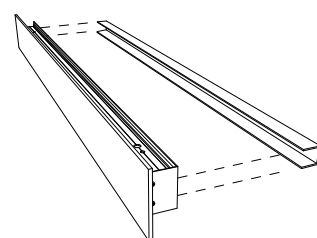
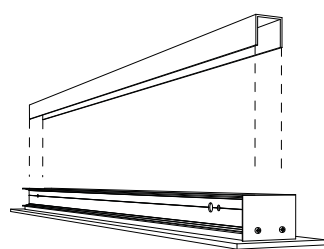

#### 2426A - 2426B - 2426C:

Incluso nella confezione dell'articolo:

- Profilo in ALUMITE® comprensivo di due testate di chiusura;
- Due schermi in metacrilato opalino goffrato;
- Frontale in KERLITE incollato al profilo in ALUMITE®;
- Un profilo ad "U" per il fissaggio a soffitto/parete;

STRIP LED 9010 DA ORDINARE SEPARATAMENTE.

EN In the packaging of each ARTICLE it is included:

- ALUMITE® profile with two end caps included;
- Two opal methacrylate cover screen;
- KERLITE front part glued to the ALUMITE® profile;
- "U" shaped profile for wall/ceiling fixing

STRIP LED TO BE ORDERED SEPARATELY

DE In der Verpackung des einzelnen Artikels ist einbegriffen:

- ALUMITE® Profil mit zwei EndKappen;
- Zwei Abdeckung in Opal-Methacrylat;
- KERLITE-Vorderteil mit dem mit dem ALUMITE®-Profil verklebt;
- U- Profil für Wand- Deckenmontage

LED STRIP SEPARAT ZU BESTELLEN

FR Dans le paquet de chaque article il est inclus:

- Profil en ALUMITE® avec deux tête de fermeturees;
- Deux couvertures opales en methacrylate;
- Partie antérieure en KERLITE collée au profilé en ALUMITE®;
- Profilé à "U" pour la fixation au mur / au plafond

RUBAN LED A' COMMANDER SEPARMENT

IT Misure espresse in mm, tolleranza +/- 1-2 mm. L'azienda si riserva la facoltà di apportare variazioni di dati caratteristici, materiali, design, stili, tonalità, senza alcun preavviso.  
EN Measures in mm, tollerance +/- 1/2 mm. The company reserves the right to carry out variations to technical details, materials, design, style, colors with no previous notice.

#### DATI TECNICI / TECHNICAL DATA

2426A-371-00	L 1000 Bianco / White / Weiss / Blanc
2426A-372-00	L 1000 Grigio / Grey / Grau / Gris
2426A-373-00	L 1000 Nero / Black / Schwarz / Noir

Senza parte elettrica / Without electrical part / Ohne elektrischen Teil / Sans partie électrique

#### ACCESSORI / ACCESSORIES

LED Strip	Pg. 398
026.267	DRIVER ON/OFF SLIM max60W 24Vdc
026.268	DRIVER ON/OFF SLIM max100W 24Vdc
026.269	DRIVER ON/OFF SLIM max150W 24Vdc
TGC	Taglio a misura/Custom Cut/Zuschnitt/Coupe personnalisée

LED= MAX 2x26W/m

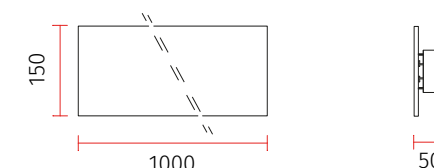

# 2426A



2,2 Kg

#### DATI TECNICI / TECHNICAL DATA

2426B-371-00	L 2000 Bianco / White / Weiss / Blanc
2426B-372-00	L 2000 Grigio / Grey / Grau / Gris
2426B-373-00	L 2000 Nero / Black / Schwarz / Noir

Senza parte elettrica / Without electrical part / Ohne elektrischen Teil / Sans partie électrique

#### ACCESSORI / ACCESSORIES

LED Strip	Pg. 398
026.267	DRIVER ON/OFF SLIM max60W 24Vdc
026.268	DRIVER ON/OFF SLIM max100W 24Vdc
026.269	DRIVER ON/OFF SLIM max150W 24Vdc
TGC	Taglio a misura/Custom Cut/Zuschnitt/Coupe personnalisée

LED= MAX 2x26W/m

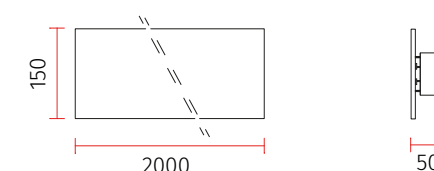

# 2426B



4,2 Kg

#### DATI TECNICI / TECHNICAL DATA

2426C-371-00	L 3000 Bianco / White / Weiss / Blanc
2426C-372-00	L 3000 Grigio / Grey / Grau / Gris
2426C-373-00	L 3000 Nero / Black / Schwarz / Noir

Senza parte elettrica / Without electrical part / Ohne elektrischen Teil / Sans partie électrique

#### ACCESSORI / ACCESSORIES

LED Strip	Pg. 398
026.267	DRIVER ON/OFF SLIM max60W 24Vdc
026.268	DRIVER ON/OFF SLIM max100W 24Vdc
026.269	DRIVER ON/OFF SLIM max150W 24Vdc
TGC	Taglio a misura/Custom Cut/Zuschnitt/Coupe personnalisée

LED= MAX 2x26W/m

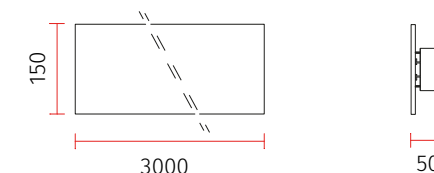

# 2426C



6,2 Kg

DE Die Masse sind in mm, mit einer Tolleranz von +/- 1-2 mm ausgedrückt, Die Firma behält sich das Recht vor ohne Voranmeldung Änderungen an den Werkstoffen, am Design, am Stil und an der Färbung vorzunehmen.  
FR Mesures en mm, tolérance +/- 1/2 mm. La société se réserve le droit de modifier sans préavis les détails techniques, les matériaux, le design, le style et les couleurs.

373 NERO / BLACK



372 GRIGIO / GREY

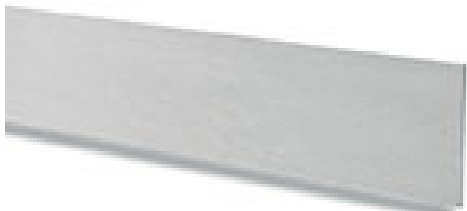

371 BIANCO / WHITE



# A PLAFONE E A PARETE

## Ceiling and Wall Lighting

### Decken- und Wandbeleuchtung

### Plafonniers et Appliques

CERAMICA 900

made in Italy

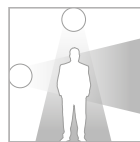

FINITURE SU RICHIESTA / FINISHES ON DEMAND  
 OBERFLÄCHENVERARBEITUNGEN AUF NACHFRAGE / FINITIONS SUR DEMANDE:



390  
CORTEN



391  
OSSIDO  
OXIDE

Art. 8879 - Private house - Siena, Italy



Diffusore in vetro  
 Glass diffuser  
 Glasabdeckung  
 Diffuseur en verre

IT Misure espresse in mm, tolleranza +/- 1-2 mm. L'azienda si riserva la facoltà di apportare variazioni di dati caratteristici, materiali, design, stili, tonalità, senza alcun preavviso.  
 EN Measures in mm, tolerance +/- 1/2 mm. The company reserves the right to carry out variations to technical details, materials, design, style, colors with no previous notice.

#### DATI TECNICI / TECHNICAL DATA

8879-81	E27 2X42W-240V L 130mm
8879-3049	LED 14W-220-240V-1400lm-3000°K-CRI80

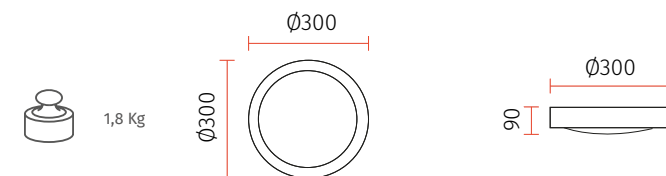

8879



#### DATI TECNICI / TECHNICAL DATA

8881-81	E27 2X42W-240V L 150mm
8881-3049	LED 14W-220-240V-1400lm-3000°K-CRI80

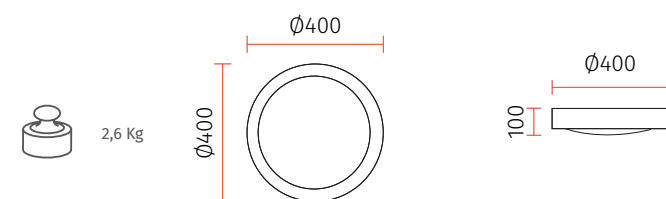

8881

#### DATI TECNICI / TECHNICAL DATA

8882-81	E27 2X42W-240V L 180mm
8882-3049	LED 14W-220-240V-1400lm-3000°K-CRI80

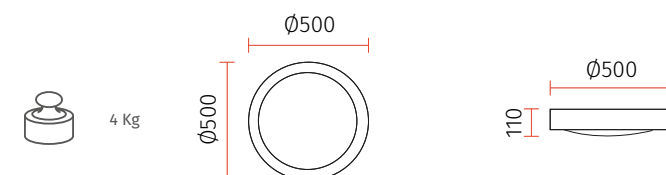

8882

#### DATI TECNICI / TECHNICAL DATA

8883-81	E27 4X42W-240V L 150mm
---------	------------------------

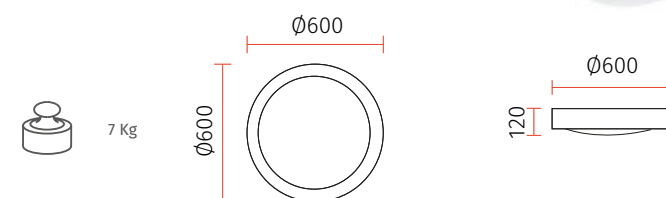

8883

DE Die Masse sind in mm, mit einer Tolleranz von +/- 1-2 mm ausgedrückt, Die Firma behält sich das Recht vor ohne Voranmeldung Änderungen an den Werkstoffen, am Design, am Stil und an der Färbung vorzunehmen.  
 FR Mesures en mm, tolérance +/- 1/2 mm. La société se réserve le droit de modifier sans préavis les détails techniques, les matériaux, le design, le style et les couleurs.

## DA INCASSO 15 mm

15 mm recessed lighting  
15 mm Einbauleuchten  
Encastrés 15 mm

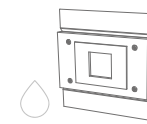

4193 p.289

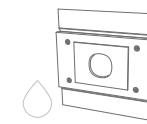

4194 p.289

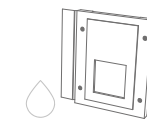

4193B p.291

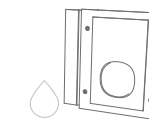

4194B p.291



**NEW** 4193F p.293

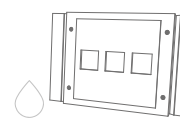

**NEW** 4193G p.293



IP20 / IP44



**INCASSO 15mm**  
**15mm recessed lighting**  
**15 mm Einbauleuchten**  
**Encastrés 15 mm**

**PATENTED**

CRISTALY®

made in Italy

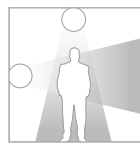

C.C. [m.A.] IP20/IP44

CASAMBI Pg.408

Art. 4193 - Private house - Venezia, Italy

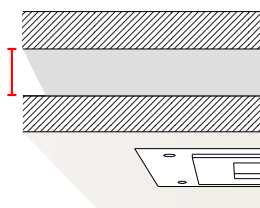

Installazione in 15 mm  
 Installation in 15 mm  
 Einbau in 15 mm  
 Installation en 15 mm



Diffusore in vetro  
 Glass diffuser  
 Glasabdeckung  
 Diffuseur en verre

**DATI TECNICI / TECHNICAL DATA**

4193-3006	LED 6.5W-350mA-850lm-3000°K-CRI90
4193-2706	LED 6.5W-350mA-800lm-2700°K-CRI90
4193-4006	LED 6.5W-350mA-900lm-4000°K-CRI90
026.251	DRIVER ON/OFF min6W max8.8W 350mA
026.252	DRIVER ON/OFF min12.6W max18.2W 350mA
026.221	DRIVER ON/OFF min9.8W max35W 350mA
026.219	DRIVER DIM PUSH/0-10V/DALI 16.1W 350mA
026.187	DRIVER DIM 0-10V 35W 350mA
026.185	DRIVER DIM PUSH/DALI 35W 350mA
4193-3008	LED 13W-700mA-1600lm-3000°K-CRI90
4193-2708	LED 13W-700mA-1500lm-2700°K-CRI90
4193-4008	LED 13W-700mA-1700lm-4000°K-CRI90
026.255	DRIVER ON/OFF min11.9W max18.2W 700mA
026.256	DRIVER ON/OFF min24.9W max35.7W 700mA
026.219	DRIVER DIM PUSH/0-10V/DALI 19.6W 700mA
026.207	DRIVER DIM 0-10V 60.2W 700mA

**ACCESSORI / ACCESSORIES**

023.492	Controcassa per muratura / Housing box for brickwork / Einbaugehäuse für Betonwand / Boîtier pour béton/briques [210x220x30mm]
099.142	Pg.415 Kit emergenza / Emergency Kit

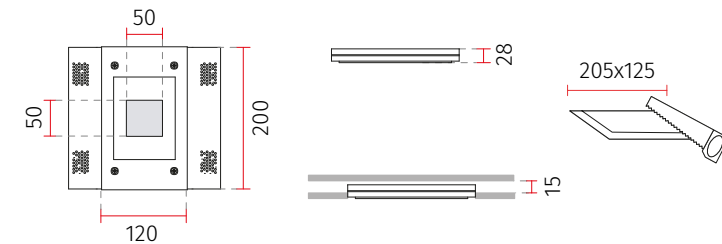

4193



0,7 Kg

**DATI TECNICI / TECHNICAL DATA**

4194-3006	LED 6.5W-350mA-850lm-3000°K-CRI90
4194-2706	LED 6.5W-350mA-800lm-2700°K-CRI90
4194-4006	LED 6.5W-350mA-900lm-4000°K-CRI90
026.251	DRIVER ON/OFF min6W max8.8W 350mA
026.252	DRIVER ON/OFF min12.6W max18.2W 350mA
026.221	DRIVER ON/OFF min9.8W max35W 350mA
026.219	DRIVER DIM PUSH/0-10V/DALI 16.1W 350mA
026.187	DRIVER DIM 0-10V 35W 350mA
026.185	DRIVER DIM PUSH/DALI 35W 350mA
4194-3008	LED 13W-700mA-1600lm-3000°K-CRI90
4194-2708	LED 13W-700mA-1500lm-2700°K-CRI90
4194-4008	LED 13W-700mA-1700lm-4000°K-CRI90
026.255	DRIVER ON/OFF min11.9W max18.2W 700mA
026.256	DRIVER ON/OFF min24.9W max35.7W 700mA
026.219	DRIVER DIM PUSH/0-10V/DALI 19.6W 700mA
026.207	DRIVER DIM 0-10V 60.2W 700mA
026.206	DRIVER DIM PUSH/DALI 60.2W 700mA

**ACCESSORI / ACCESSORIES**

023.492	Controcassa per muratura / Housing box for brickwork / Einbaugehäuse für Betonwand / Boîtier pour béton/briques [210x220x30mm]
099.142	Pg.415 Kit emergenza / Emergency Kit

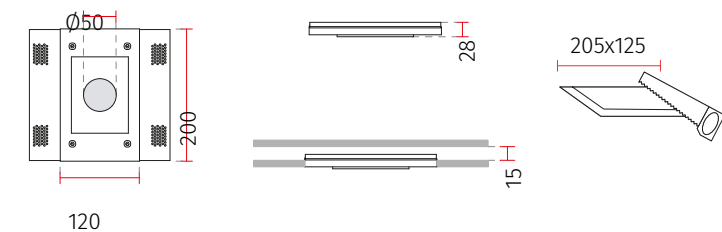

4194



0,7 Kg

IT Misure espresse in mm, tolleranza +/- 1-2 mm. L'azienda si riserva la facoltà di apportare variazioni di dati caratteristici, materiali, design, stili, tonalità, senza alcun preavviso.  
 EN Measures in mm, tolerance +/- 1/2 mm. The company reserves the right to carry out variations to technical details, materials, design, style, colors with no previous notice.

DE Die Masse sind in mm, mit einer Tolleranz von +/- 1-2 mm ausgedrückt, Die Firma behält sich das Recht vor ohne Voranmeldung Änderungen an den Werkstoffen, am Design, am Stil und an der Färbung vorzunehmen.  
 FR Mesures en mm, tolérance +/- 1/2 mm. La société se réserve le droit de modifier sans préavis les détails techniques, les matériaux, le design, le style et les couleurs.

**INCASSO 15mm**  
15mm recessed lighting  
15 mm Einbauleuchten  
Encastrés 15 mm

**PATENTED**

CRISTALY®

made in Italy

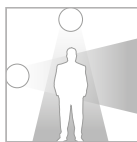

TUNABLE WHITE Pg.412 | CASAMBI Pg.408

Art. 4193B - Private house - Tampere, Finland

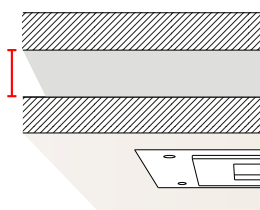

Installazione in 15 mm  
Installation in 15 mm  
Einbau in 15 mm  
Installation en 15 mm



Diffusore in vetro  
Glass diffuser  
Glasabdeckung  
Diffuseur en verre

**DATI TECNICI / TECHNICAL DATA**

4193B-3024	LED 8W-350mA-1100lm-3000°K-CRI85
4193B-2724	LED 8W-350mA-1050lm-2700°K-CRI85
4193B-4024	LED 8W-350mA-1160lm-4000°K-CRI85
026.251	DRIVER ON/OFF min6W max8.8W 350mA
026.252	DRIVER ON/OFF min12.6W max18.2W 350mA
026.221	DRIVER ON/OFF min9.8W max35W 350mA
026.219	DRIVER DIM PUSH/0-10V/DALI 16.1W 350mA
026.187	DRIVER DIM 0-10V 35W 350mA
026.185	DRIVER DIM PUSH/DALI 35W 350mA
4193B-3025	LED 16W-700mA-2200lm-3000°K-CRI85
4193B-2725	LED 16W-700mA-2090lm-2700°K-CRI85
4193B-4025	LED 16W-700mA-2330lm-4000°K-CRI85
026.255	DRIVER ON/OFF min11.9W max18.2W 700mA
026.256	DRIVER ON/OFF min24.9W max35.7W 700mA
026.219	DRIVER DIM PUSH/0-10V/DALI 19.6W 700mA
026.207	DRIVER DIM 0-10V 60.2W 700mA
026.206	DRIVER DIM PUSH/DALI 60.2W 700mA

**ACCESSORI / ACCESSORIES**

099.142	Pg.415 Kit emergenza / Emergency Kit
---------	--------------------------------------

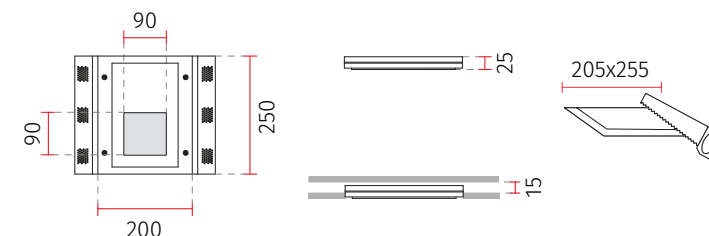

4193B



1,3 Kg

**DATI TECNICI / TECHNICAL DATA**

4194B-3006	LED 6.5W-350mA-850lm-3000°K-CRI90
4194B-2706	LED 6.5W-350mA-800lm-2700°K-CRI90
4194B-4006	LED 6.5W-350mA-900lm-4000°K-CRI90
026.251	DRIVER ON/OFF min6W max8.8W 350mA
026.252	DRIVER ON/OFF min12.6W max18.2W 350mA
026.221	DRIVER ON/OFF min9.8W max35W 350mA
026.219	DRIVER DIM PUSH/0-10V/DALI 16.1W 350mA
026.187	DRIVER DIM 0-10V 35W 350mA
026.185	DRIVER DIM PUSH/DALI 35W 350mA
4194B-3008	LED 13W-700mA-1600lm-3000°K-CRI90
4194B-2708	LED 13W-700mA-1500lm-2700°K-CRI90
4194B-4008	LED 13W-700mA-1700lm-4000°K-CRI90
026.255	DRIVER ON/OFF min11.9W max18.2W 700mA
026.256	DRIVER ON/OFF min24.9W max35.7W 700mA
026.219	DRIVER DIM PUSH/0-10V/DALI 19.6W 700mA
026.207	DRIVER DIM 0-10V 60.2W 700mA
026.206	DRIVER DIM PUSH/DALI 60.2W 700mA

**ACCESSORI / ACCESSORIES**

099.142	Pg.415 Kit emergenza / Emergency Kit
---------	--------------------------------------

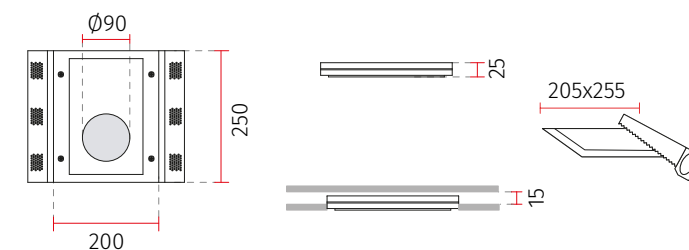

4194B



1,35 Kg

IT Misure espresse in mm, tolleranza +/- 1-2 mm. L'azienda si riserva la facoltà di apportare variazioni di dati caratteristici, materiali, design, stili, tonalità, senza alcun preavviso.  
EN Measures in mm, tolerance +/- 1/2 mm. The company reserves the right to carry out variations to technical details, materials, design, style, colors with no previous notice.

DE Die Masse sind in mm, mit einer Tolleranz von +/- 1-2 mm ausgedrückt, Die Firma behält sich das Recht vor ohne Voranmeldung Änderungen an den Werkstoffen, am Design, am Stil und an der Färbung vorzunehmen.  
FR Mesures en mm, tolérances +/- 1/2 mm. La société se réserve le droit de modifier sans préavis les détails techniques, les matériaux, le design, le style et les couleurs.

**INCASSO 15mm**  
15mm recessed lighting  
15 mm Einbauleuchten  
Encastrés 15 mm

**PATENTED**

CRISTALY®

made in Italy

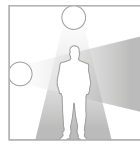

CASAMBI Pg.408

Art. 4193F - Private house - Pisa, Italy

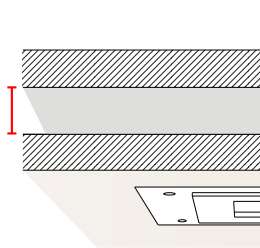

Installazione in 15 mm  
Installation in 15 mm  
Einbau in 15 mm  
Installation en 15 mm



Diffusore in vetro  
Glass diffuser  
Glasabdeckung  
Diffuseur en verre

**DATI TECNICI / TECHNICAL DATA**

4193F-3006	LED 2x6.5W-350mA-1700lm-3000°K-CRI90
4193F-2706	LED 2x6.5W-350mA-1600lm-2700°K-CRI90
4193F-4006	LED 2x6.5W-350mA-1800lm-4000°K-CRI90
026.252	DRIVER ON/OFF min12.6W max18.2W 350mA
026.221	DRIVER ON/OFF min9.8W max35W 350mA
026.219	DRIVER DIM PUSH/0-10V/DALI 16.1W 350mA
026.187	DRIVER DIM 0-10V 35W 350mA
026.185	DRIVER DIM PUSH/DALI 35W 350mA

**ACCESSORI / ACCESSORIES**

099.142	Pg.415 Kit emergenza / Emergency Kit
---------	--------------------------------------

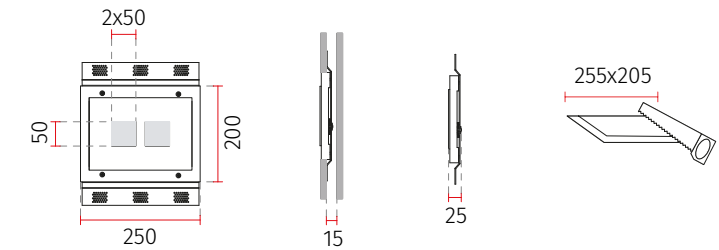

**NEW** 4193F



1,5 Kg

**DATI TECNICI / TECHNICAL DATA**

4193G-3006	LED 3x6.5W-350mA-2550lm-3000°K-CRI90
4193G-2706	LED 3x6.5W-350mA-2400lm-2700°K-CRI90
4193G-4006	LED 3x6.5W-350mA-2700lm-4000°K-CRI90
026.221	DRIVER ON/OFF min9.8W max35W 350mA
026.187	DRIVER DIM 0-10V 35W 350mA
026.185	DRIVER DIM PUSH/DALI 35W 350mA

**ACCESSORI / ACCESSORIES**

099.142	Pg.415 Kit emergenza / Emergency Kit
---------	--------------------------------------

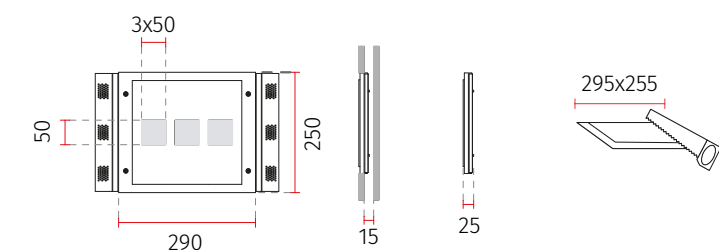

**NEW** 4193G



2,05 Kg

IT Misure espresse in mm, tolleranza +/- 1-2 mm. L'azienda si riserva la facoltà di apportare variazioni di dati caratteristici, materiali, design, stili, tonalità, senza alcun preavviso.  
EN Measures in mm, tolerance +/- 1/2 mm. The company reserves the right to carry out variations to technical details, materials, design, style, colors with no previous notice.





DE Die Masse sind in mm, mit einer Tolleranz von +/- 1-2 mm ausgedrückt, Die Firma behält sich das Recht vor ohne Voranmeldung Änderungen an den Werkstoffen, am Design, am Stil und an der Färbung vorzunehmen.  
FR Mesures en mm, tolérance +/- 1/2 mm. La société se réserve le droit de modifier sans préavis les détails techniques, les matériaux, le design, le style et les couleurs.

# SEGNAPASSI

Pathmarkers

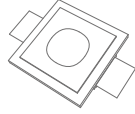
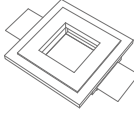
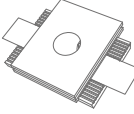
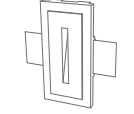
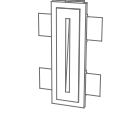
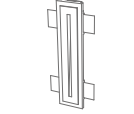
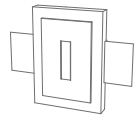
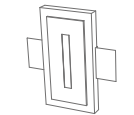
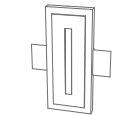
Orientierungsbeleuchtung

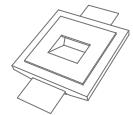
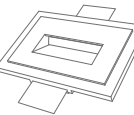
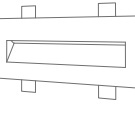
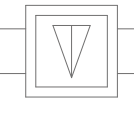
Balisages encastrés

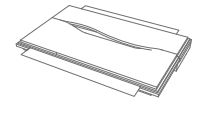
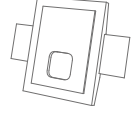
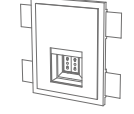
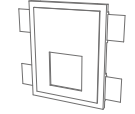
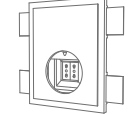
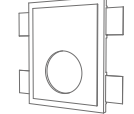
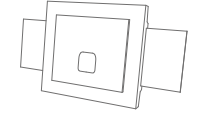
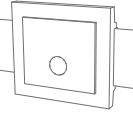
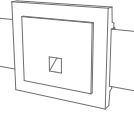
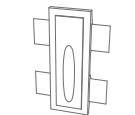
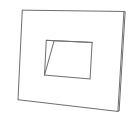
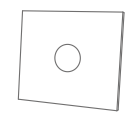
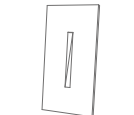
					
4058 p.297	4062 p.297	4099 p.297	4100E p.299	4100F p.299	4100G p.299
					
4130A p.303	4130B p.303	4130C p.303	4160 p.304	4154B p.305	4155B p.305
					
4156 p.305	4112 p.306	4164 p.307	4167 p.307	4199 p.307	4195A p.311
					
4195B p.311	<b>NEW</b> 4195C p.313	<b>NEW</b> 4195D p.313	4198 p.315	4201 p.315	4202 p.315
					
4204B p.315	<b>NEW</b> 4205A p.319	<b>NEW</b> 4205B p.319	<b>NEW</b> 4205C p.319		

# SEGNAPASSI

## Pathmarkers

### Orientierungsbeleuchtung

### Balisages encastrés

CRISTALY<sup>®</sup>

made in Italy



CASAMBI Pg.408

Art. 4062 - Private house - London, UK



Sistema Multitaglia  
Multi-size system  
P.417



DATI TECNICI / TECHNICAL DATA	
4058-3001	LED 3.5W-24Vdc-350lm-3000°K-CRI90
4058-2701	LED 3.5W-24Vdc-330lm-2700°K-CRI90
4058-4001	LED 3.5W-24Vdc-370lm-4000°K-CRI90
026.258	DRIVER ON/OFF 12W 24V
026.259	DRIVER ON/OFF 36W 24V
026.260	DRIVER ON/OFF 60W 24V
026.219	DRIVER DIM PUSH/0-10V/DALI 21.6W 24V
026.209	DRIVER DIM PUSH/1-10V 60W 24V

ACCESSORI / ACCESSORIES	
023.453	Controcassa per muratura / Housing box for brickwork / Einbaugehäuse für Betonwand / Boîtier pour béton/briques [155x155x50mm]
099.142	Pg.415 Kit emergenza / Emergency Kit

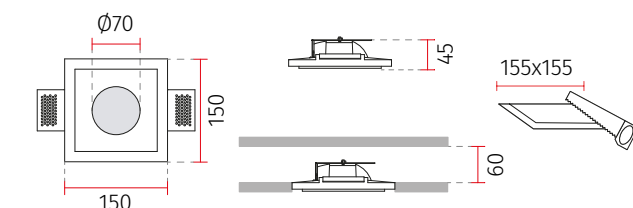

4058

0,55 Kg

DATI TECNICI / TECHNICAL DATA	
4062-3001	LED 3.5W-24Vdc-350lm-3000°K-CRI90
4062-2701	LED 3.5W-24Vdc-330lm-2700°K-CRI90
4062-4001	LED 3.5W-24Vdc-370lm-4000°K-CRI90
026.258	DRIVER ON/OFF 12W 24V
026.259	DRIVER ON/OFF 36W 24V
026.260	DRIVER ON/OFF 60W 24V
026.219	DRIVER DIM PUSH/0-10V/DALI 21.6W 24V
026.209	DRIVER DIM PUSH/1-10V 60W 24V

ACCESSORI / ACCESSORIES	
023.453	Controcassa per muratura / Housing box for brickwork / Einbaugehäuse für Betonwand / Boîtier pour béton/briques [155x155x50mm]
099.142	Pg.415 Kit emergenza / Emergency Kit

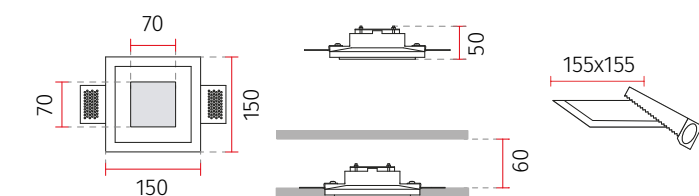

4062

0,65 Kg

DATI TECNICI / TECHNICAL DATA	
4099-3000	LED 2W-24Vdc-200lm-3000°K-CRI90
4099-2700	LED 2W-24Vdc-190lm-2700°K-CRI90
4099-4000	LED 2W-24Vdc-210lm-4000°K-CRI90
026.258	DRIVER ON/OFF 12W 24V
026.259	DRIVER ON/OFF 36W 24V
026.260	DRIVER ON/OFF 60W 24V
026.219	DRIVER DIM PUSH/0-10V/DALI 21.6W 24V
026.209	DRIVER DIM PUSH/1-10V 60W 24V

ACCESSORI / ACCESSORIES	
023.411	Controcassa per muratura / Housing box for brickwork / Einbaugehäuse für Betonwand / Boîtier pour béton/briques [105x115x70mm]
099.142	Pg.415 Kit emergenza / Emergency Kit

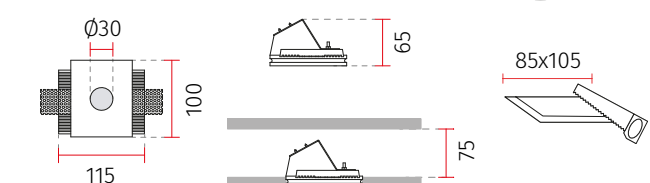

4099

0,5 Kg

IT Misure espresse in mm, tolleranza +/- 1-2 mm. L'azienda si riserva la facoltà di apportare variazioni di dati caratteristici, materiali, design, stili, tonalità, senza alcun preavviso.  
EN Measures in mm, tolerance +/- 1/2 mm. The company reserves the right to carry out variations to technical details, materials, design, style, colors with no previous notice.

DE Die Masse sind in mm, mit einer Tolleranz von +/- 1-2 mm ausgedrückt, Die Firma behält sich das Recht vor ohne Voranmeldung Änderungen an den Werkstoffen, am Design, am Stil und an der Färbung vorzunehmen.  
FR Mesures en mm, tolérance +/- 1/2 mm. La société se réserve le droit de modifier sans préavis les détails techniques, les matériaux, le design, le style et les couleurs.

# SEGNAPASSI

## Pathmarkers

### Orientierungsbeleuchtung

### Balisages encastrés

CRISTALY®

made in Italy



CASAMBI Pg.408

Art. 4100E - Private house - Vicenza, Italy



Sistema Multitaglia  
Multi-size system  
P.417



LED ispezionabile senza lavori di muratura  
LED maintenance without masonry work  
LED-Wartung ohne Mauerwerk  
Entretien des LED sans travaux de maçonnerie

#### DATI TECNICI / TECHNICAL DATA

4100E-3000	LED 2W-24Vdc-200lm-3000°K-CRI90
4100E-2700	LED 2W-24Vdc-190lm-2700°K-CRI90
4100E-4000	LED 2W-24Vdc-210lm-4000°K-CRI90
026.258	DRIVER ON/OFF 12W 24V
026.259	DRIVER ON/OFF 36W 24V
026.260	DRIVER ON/OFF 60W 24V
026.219	DRIVER DIM PUSH/0-10V/DALI 21.6W 24V
026.209	DRIVER DIM PUSH/1-10V 60W 24V

#### ACCESSORI / ACCESSORIES

023.496	Controcassa per muratura / Housing box for brickwork / Einbaugehäuse für Betonwand / Boîtier pour béton/briques [95x185x70mm]
099.142	Pg.415 Kit emergenza / Emergency Kit

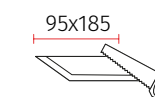
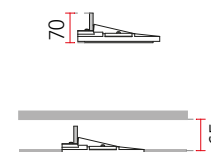
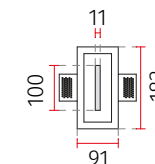

4100E



0,65 Kg

#### DATI TECNICI / TECHNICAL DATA

4100F-3000	LED 2W-24Vdc-200lm-3000°K-CRI90
4100F-2700	LED 2W-24Vdc-190lm-2700°K-CRI90
4100F-4000	LED 2W-24Vdc-210lm-4000°K-CRI90
026.258	DRIVER ON/OFF 12W 24V
026.259	DRIVER ON/OFF 36W 24V
026.260	DRIVER ON/OFF 60W 24V
026.219	DRIVER DIM PUSH/0-10V/DALI 21.6W 24V
026.209	DRIVER DIM PUSH/1-10V 60W 24V

#### ACCESSORI / ACCESSORIES

023.497	Controcassa per muratura / Housing box for brickwork / Einbaugehäuse für Betonwand / Boîtier pour béton/briques [95x285x70mm]
099.142	Pg.415 Kit emergenza / Emergency Kit

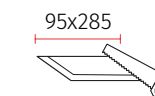
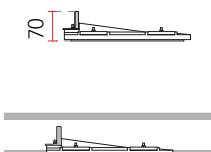
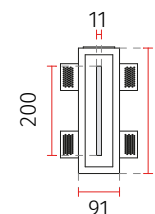

4100F



0,9 Kg

#### DATI TECNICI / TECHNICAL DATA

4100G-3000	LED 2W-24Vdc-200lm-3000°K-CRI90
4100G-2700	LED 2W-24Vdc-190lm-2700°K-CRI90
4100G-4000	LED 2W-24Vdc-210lm-4000°K-CRI90
026.258	DRIVER ON/OFF 12W 24V
026.259	DRIVER ON/OFF 36W 24V
026.260	DRIVER ON/OFF 60W 24V
026.219	DRIVER DIM PUSH/0-10V/DALI 21.6W 24V
026.209	DRIVER DIM PUSH/1-10V 60W 24V

#### ACCESSORI / ACCESSORIES

023.498	Controcassa per muratura / Housing box for brickwork / Einbaugehäuse für Betonwand / Boîtier pour béton/briques [95x390x70mm]
099.142	Pg.415 Kit emergenza / Emergency Kit

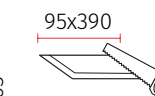
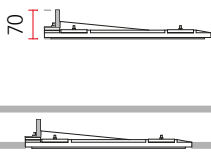
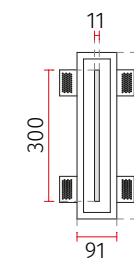

4100G



1,2 Kg

IT Misure espresse in mm, tolleranza +/- 1-2 mm. L'azienda si riserva la facoltà di apportare variazioni di dati caratteristici, materiali, design, stili, tonalità, senza alcun preavviso.  
EN Measures in mm, tolerance +/- 1/2 mm. The company reserves the right to carry out variations to technical details, materials, design, style, colors with no previous notice.

DE Die Masse sind in mm, mit einer Tolleranz von +/- 1-2 mm ausgedrückt, Die Firma behält sich das Recht vor ohne Voranmeldung Änderungen an den Werkstoffen, am Design, am Stil und an der Färbung vorzunehmen.  
FR Mesures en mm, tolérance +/- 1/2 mm. La société se réserve le droit de modifier sans préavis les détails techniques, les matériaux, le design, le style et les couleurs.



# SEGNAPASSI

## Pathmarkers

### Orientierungsbeleuchtung

### Balisages encastrés

CRISTALY®

made in Italy



CASAMBI Pg.408

Art. 4130B - Private house - Malaga, Spain



Sistema Multitaglia  
Multi-size system  
P.417

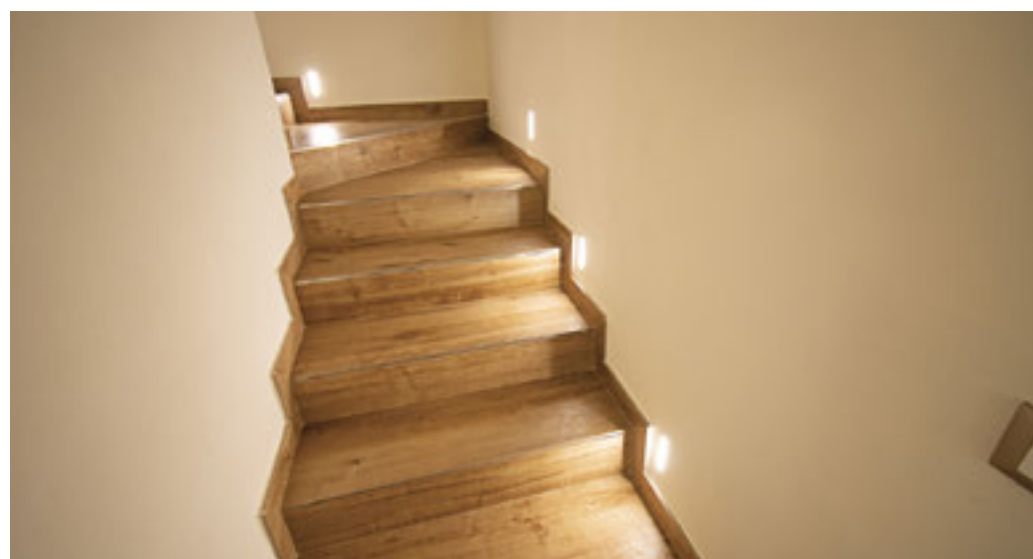

DATI TECNICI / TECHNICAL DATA	
4130A-3003	LED 1.5W-24Vdc-150lm-3000°K-CRI90
4130A-2703	LED 1.5W-24Vdc-140lm-2700°K-CRI90
4130A-4003	LED 1.5W-24Vdc-160lm-4000°K-CRI90
026.258	DRIVER ON/OFF 12W 24V
026.259	DRIVER ON/OFF 36W 24V
026.260	DRIVER ON/OFF 60W 24V
026.219	DRIVER DIM PUSH/0-10V/DALI 21.6W 24V
026.209	DRIVER DIM PUSH/1-10V 60W 24V

ACCESSORI / ACCESSORIES	
023.4100	Controcassa per muratura / Housing box for brickwork / Einbaugehäuse für Betonwand / Boîtier pour béton/briques [110x150x50mm]
099.142	Pg.415 Kit emergenza / Emergency Kit

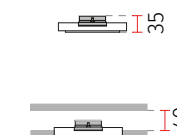
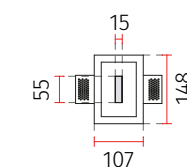

4130A



0,55 Kg

110x150

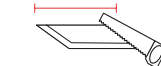

DATI TECNICI / TECHNICAL DATA	
4130B-3003	LED 2.5W-24Vdc-300lm-3000°K-CRI90
4130B-2703	LED 2.5W-24Vdc-280lm-2700°K-CRI90
4130B-4003	LED 2.5W-24Vdc-315lm-4000°K-CRI90
026.258	DRIVER ON/OFF 12W 24V
026.259	DRIVER ON/OFF 36W 24V
026.260	DRIVER ON/OFF 60W 24V
026.219	DRIVER DIM PUSH/0-10V/DALI 21.6W 24V
026.209	DRIVER DIM PUSH/1-10V 60W 24V

ACCESSORI / ACCESSORIES	
023.4101	Controcassa per muratura / Housing box for brickwork / Einbaugehäuse für Betonwand / Boîtier pour béton/briques [110x200x50mm]
099.142	Pg.415 Kit emergenza / Emergency Kit

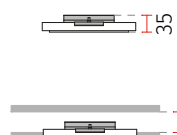
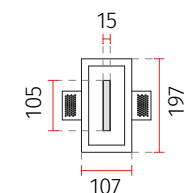

4130B



0,8 Kg

110x200

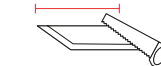

DATI TECNICI / TECHNICAL DATA	
4130C-3003	LED 4W-24Vdc-450lm-3000°K-CRI90
4130C-2703	LED 4W-24Vdc-430lm-2700°K-CRI90
4130C-4003	LED 4W-24Vdc-470lm-4000°K-CRI90
026.258	DRIVER ON/OFF 12W 24V
026.259	DRIVER ON/OFF 36W 24V
026.260	DRIVER ON/OFF 60W 24V
026.219	DRIVER DIM PUSH/0-10V/DALI 21.6W 24V
026.209	DRIVER DIM PUSH/1-10V 60W 24V

ACCESSORI / ACCESSORIES	
023.4102	Controcassa per muratura / Housing box for brickwork / Einbaugehäuse für Betonwand / Boîtier pour béton/briques [110x250x50mm]
099.142	Pg.415 Kit emergenza / Emergency Kit

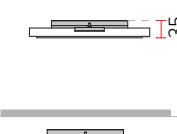
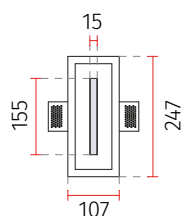

4130C



0,95 Kg

110x250

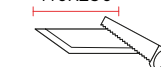

IT Misure espresse in mm, tolleranza +/- 1-2 mm. L'azienda si riserva la facoltà di apportare variazioni di dati caratteristici, materiali, design, stili, tonalità, senza alcun preavviso.  
EN Measures in mm, tolerance +/- 1/2 mm. The company reserves the right to carry out variations to technical details, materials, design, style, colors with no previous notice.

DE Die Masse sind in mm, mit einer Tolleranz von +/- 1-2 mm ausgedrückt, Die Firma behält sich das Recht vor ohne Voranmeldung Änderungen an den Werkstoffen, am Design, am Stil und an der Färbung vorzunehmen.  
FR Mesures en mm, tolérance +/- 1/2 mm. La société se réserve le droit de modifier sans préavis les détails techniques, les matériaux, le design, le style et les couleurs.



# SEGNAPASSI

## Pathmarkers

### Orientierungsbeleuchtung

### Balisages encastrés

CRISTALY®

made in Italy



CASAMBI Pg.408

#### 4154B - 4155B - 4156:

Con schermo trasparente (opalino su richiesta)

EN Transparent cover included (opal cover available on demand)

DE Transparente Abdeckung eingeschlossen (Abdeckung in Opalen-Kunststoff verfügbar auf Anfrage)

FR Avec couverture transparente (couverture opale sur demande)

Art. 4160 - Private house - Lecco, Italy

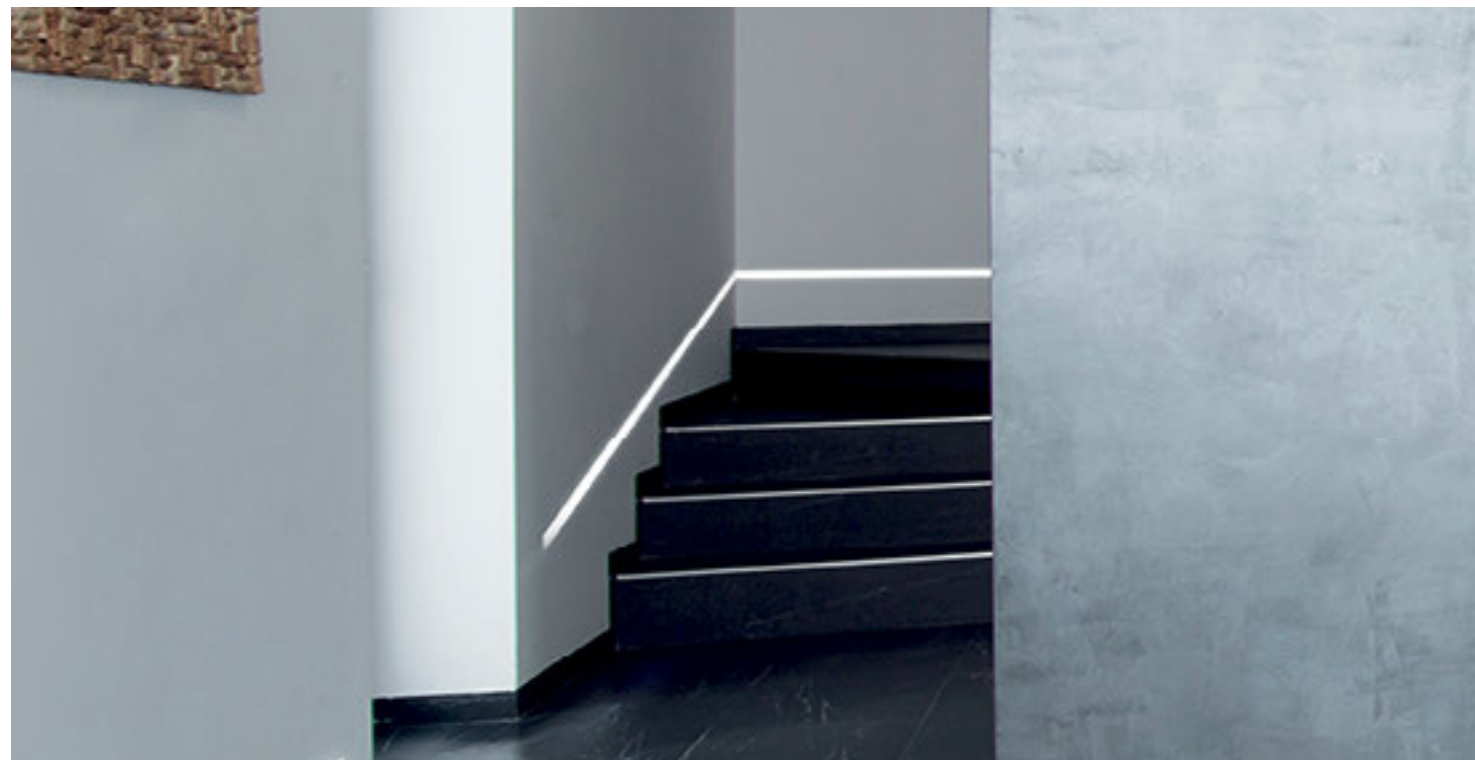

#### DATI TECNICI / TECHNICAL DATA

4154B-3004	LED 1.1W-24Vdc-100lm-3000°K-CRI85
4154B-2704	LED 1.1W-24Vdc-95lm-2700°K-CRI85
4154B-4004	LED 1.1W-24Vdc-106lm-4000°K-CRI85
026.258	DRIVER ON/OFF 12W 24V
026.259	DRIVER ON/OFF 36W 24V
026.260	DRIVER ON/OFF 60W 24V
026.219	DRIVER DIM PUSH/0-10V/DALI 21.6W 24V
026.209	DRIVER DIM PUSH/1-10V 60W 24V

#### ACCESSORI / ACCESSORIES

023.478	Controcassa per muratura / Housing box for brickwork / Einbaugeschäuse für Betonwand / Boîtier pour béton/briques [140x140x75mm]
099.142	Pg.415 Kit emergenza / Emergency Kit

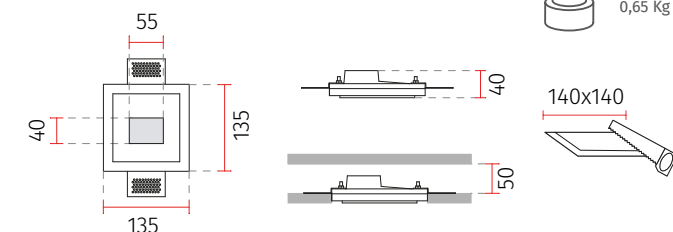

# 4154B



0,65 Kg

#### DATI TECNICI / TECHNICAL DATA

4155B-3004	LED 2.2W-24Vdc-200lm-3000°K-CRI85
4155B-2704	LED 2.2W-24Vdc-190lm-2700°K-CRI85
4155B-4004	LED 2.2W-24Vdc-213lm-4000°K-CRI85
026.258	DRIVER ON/OFF 12W 24V
026.259	DRIVER ON/OFF 36W 24V
026.260	DRIVER ON/OFF 60W 24V
026.219	DRIVER DIM PUSH/0-10V/DALI 21.6W 24V
026.209	DRIVER DIM PUSH/1-10V 60W 24V

#### ACCESSORI / ACCESSORIES

023.452	Controcassa per muratura / Housing box for brickwork / Einbaugeschäuse für Betonwand / Boîtier pour béton/briques [140x200x55mm]
099.142	Pg.415 Kit emergenza / Emergency Kit

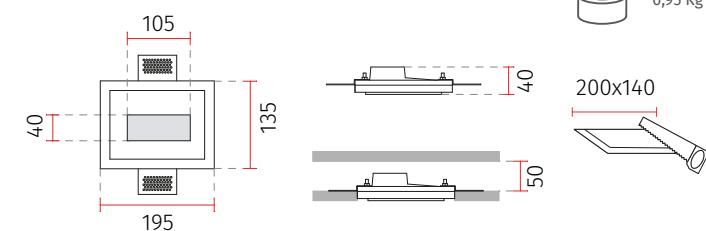

# 4155B



0,95 Kg

#### DATI TECNICI / TECHNICAL DATA

4156-3004	LED 5.5W-24Vdc-500lm-3000°K-CRI85
4156-2704	LED 5.5W-24Vdc-475lm-2700°K-CRI85
4156-4004	LED 5.5W-24Vdc-530lm-4000°K-CRI85
026.258	DRIVER ON/OFF 12W 24V
026.259	DRIVER ON/OFF 36W 24V
026.260	DRIVER ON/OFF 60W 24V
026.261	DRIVER ON/OFF 150W 24V
026.262	DRIVER ON/OFF 240W 24V
026.219	DRIVER DIM PUSH/0-10V/DALI 21.6W 24V
026.209	DRIVER DIM PUSH/1-10V 60W 24V
026.190+026.261	DRIVER DIM PUSH/0-10V/DALI 150W 24V
026.190+026.262	DRIVER DIM PUSH/0-10V/DALI 240W 24V

#### ACCESSORI / ACCESSORIES

023.422	Controcassa per muratura / Housing box for brickwork / Einbaugeschäuse für Betonwand / Boîtier pour béton/briques [140x200x55mm]
099.142	Pg.415 Kit emergenza / Emergency Kit

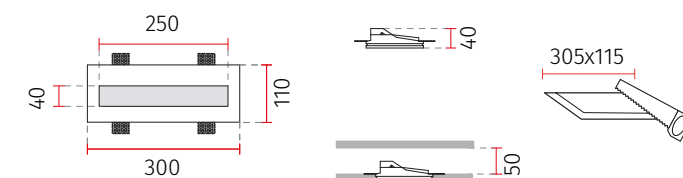

# 4156



1,2 Kg

# 4160



6,7 Kg

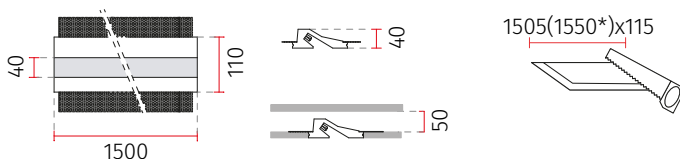

#### DATI TECNICI / TECHNICAL DATA

4160-00	L 1500 - Senza parte elettrica / Without electrical part / Ohne elektrischen Teil / Sans partie électrique
---------	--

#### ACCESSORI / ACCESSORIES

LED Strip	Pg. 398
-----------	---------

LED= MAX 20W/m

\*= Misure comprensive di parti terminali / Terminal parts are included in measures / Endkappen sind in der Abmessung eingeschlossen / Les tête de fermetures sont comprises dans les mesures

IT Misure espresse in mm, tolleranza +/- 1-2 mm. L'azienda si riserva la facoltà di apportare variazioni di dati caratteristici, materiali, design, stili, tonalità, senza alcun preavviso.  
EN Measures in mm, tolerance +/- 1/2 mm. The company reserves the right to carry out variations to technical details, materials, design, style, colors with no previous notice.

DE Die Maße sind in mm, mit einer Tolleranz von +/- 1-2 mm ausgedrückt. Die Firma behält sich das Recht vor ohne Voranmeldung Änderungen an den Werkstoffen, am Design, am Stil und an der Färbung vorzunehmen.  
FR Mesures en mm, tolérance +/- 1/2 mm. La société se réserve le droit de modifier sans préavis les détails techniques, les matériaux, le design, le style et les couleurs.

# SEGNAPASSI

## Pathmarkers

### Orientierungsbeleuchtung

### Balisages encastrés

CRISTALY®

made in Italy



CASAMBI Pg.408

Art. 4112 - Private house - Modena, Italy



#### DATI TECNICI / TECHNICAL DATA

4164-35 GU10 Ø50 MAX 10W-240V

#### ACCESSORI / ACCESSORIES

023.446	Controcassa per muratura / Housing box for brickwork / Einbaugehäuse für Betonwand / Boîtier pour béton/briques [125x225x85mm]
L001-3018	LED 8W-220-240V-650lm-3000°K-CRI85-60°
L002-3020	LED 12W-220-240V-1000lm-3000°K-CRI85-60°
L004-3018	LED 8W-220-240V-650lm-3000°K-CRI85-30°
L005-3020	LED 12W-220-240V-1000lm-3000°K-CRI85-30°
021.231	Portalamпада / Lampholder / Lampenfassung / Source GU5.3

# 4164



0,85 Kg

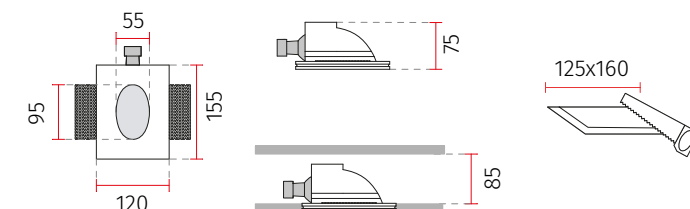

#### DATI TECNICI / TECHNICAL DATA

4167-3004	LED 6.5W-24Vdc-600lm-3000°K-CRI85
4167-2704	LED 6.5W-24Vdc-570lm-2700°K-CRI85
4167-4004	LED 6.5W-24Vdc-640lm-4000°K-CRI85
026.258	DRIVER ON/OFF 12W 24V
026.259	DRIVER ON/OFF 36W 24V
026.260	DRIVER ON/OFF 60W 24V
026.261	DRIVER ON/OFF 150W 24V
026.262	DRIVER ON/OFF 240W 24V
026.219	DRIVER DIM PUSH/0-10V/DALI 21.6W 24V
026.209	DRIVER DIM PUSH/1-10V 60W 24V
026.190+026.261	DRIVER DIM PUSH/0-10V/DALI 150W 24V
026.190+026.262	DRIVER DIM PUSH/0-10V/DALI 240W 24V

#### ACCESSORI / ACCESSORIES

023.444	Controcassa per muratura / Housing box for brickwork / Einbaugehäuse für Betonwand / Boîtier pour béton/briques [325x205x65mm]
099.142	Pg.415 Kit emergenza / Emergency Kit

# 4167



2,7 Kg

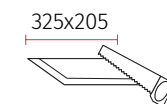
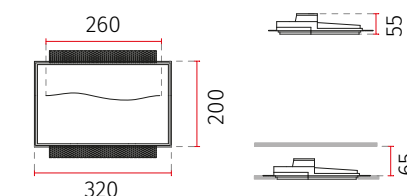

325x205

#### DATI TECNICI / TECHNICAL DATA

4199-35 GU10 Ø35 MAX 5W-240V

#### ACCESSORI / ACCESSORIES

023.446	Controcassa per muratura / Housing box for brickwork / Einbaugehäuse für Betonwand / Boîtier pour béton/briques [125x165x85mm]
L007	LED GU10 Ø35mm LED 3.2W-220-240V
021.226	Portalamпада / Lampholder / Lampenfassung / Source GU4

# 4199



0,6 Kg

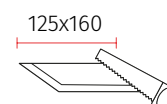
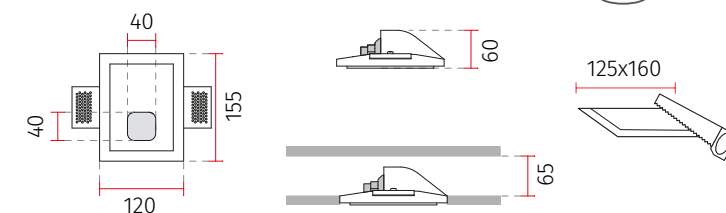

125x160

# 4112



0,55 Kg

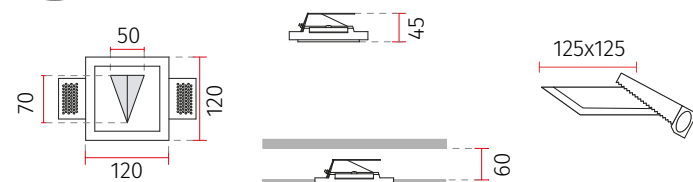

#### DATI TECNICI / TECHNICAL DATA

4112-3000	LED 2W-24Vdc-200lm-3000°K-CRI90
4112-2700	LED 2W-24Vdc-190lm-2700°K-CRI90
4112-4000	LED 2W-24Vdc-210lm-4000°K-CRI90
026.258	DRIVER ON/OFF 12W 24V
026.259	DRIVER ON/OFF 36W 24V
026.260	DRIVER ON/OFF 60W 24V
026.219	DRIVER DIM PUSH/0-10V/DALI 21.6W 24V
026.209	DRIVER DIM PUSH/1-10V 60W 24V

#### ACCESSORI / ACCESSORIES

023.421	Controcassa per muratura / Housing box for brickwork / Einbaugehäuse für Betonwand / Boîtier pour béton/briques [125x125x60mm]
099.142	Pg.415 Kit emergenza / Emergency Kit

IT Misure espresse in mm, tolleranza +/- 1-2 mm. L'azienda si riserva la facoltà di apportare variazioni di dati caratteristici, materiali, design, stili, tonalità, senza alcun preavviso.  
EN Measures in mm, tolerance +/- 1/2 mm. The company reserves the right to carry out variations to technical details, materials, design, style, colors with no previous notice.

DE Die Masse sind in mm, mit einer Tolleranz von +/- 1-2 mm ausgedrückt, Die Firma behält sich das Recht vor ohne Voranmeldung Änderungen an den Werkstoffen, am Design, am Stil und an der Färbung vorzunehmen.  
FR Mesures en mm, tolérance +/- 1/2 mm. La société se réserve le droit de modifier sans préavis les détails techniques, les matériaux, le design, le style et les couleurs.

# PRESA DI LUCE



**PRESA A SCOMPARSA**  
RECESSED SOCKET

**INTERAMENTE INCASSATO**  
ENTIRELY RECESSED

**COMPATIBILE CON SCATOLE ESISTENTI**  
SUITABLE FOR ANY ELECTRICAL BOX

**A**

**Corpo in CRISTALY®**  
CRISTALY® frame  
CRISTALY®-Rahmen  
Cadre en CRISTALY®

**B**

**Scatola di derivazione**  
Junction box  
Anschlusskasten  
Boîte de dérivation

**C**

**Strip LED**  
Strip LED



**D**

**Frutto per presa elettrica**  
Electrical plug device  
Steckdose  
Fruit pour prise électrique

**E**

**Pannello in metacrilato satinato**  
Panel in satin methacrylate / Platte aus  
satiniertem Methacrylat / Panneau en  
méthacrylate satiné

9010 presenta il segnapasso con luce a LED e presa elettrica integrata. Grazie a uno speciale sistema di incasso (brevetto depositato), basta un semplice gesto per far scorrere il frontalino in vetro satinato e accedere alla presa elettrica integrata.

EN 9010 introduces the lighting system with integrated LEDs and integrated electrical socket. Thanks to a patented system, you can easily lift the glass front and access the power outlet.

DE 9010 führt das Beleuchtungssystem mit integrierten LEDs und integrierter Steckdose ein. Dank eines patentierten Systems können Sie die Glasfront leicht anheben und auf die Steckdose zugreifen.

FR 9010 présente le système d'éclairage avec LED intégrées et prise intégrée. Grâce à un système breveté, vous pouvez facilement soulever la façade en verre et accéder à la prise de courant.

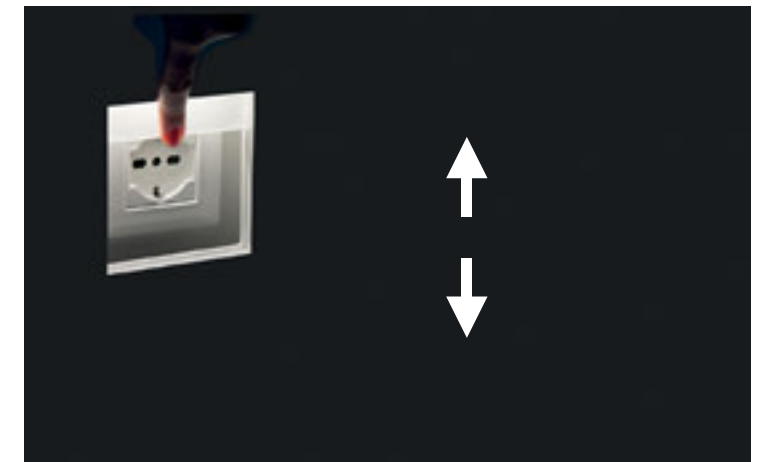

**Presa di corrente incassata**

Recessed electrical socket /  
Einbau-Steckdose / Prise de courant  
encastrée

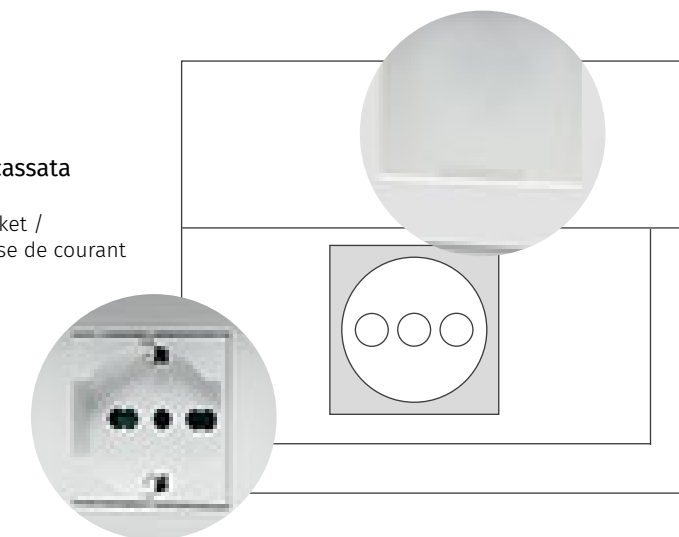

**Pannello in metacrilato satinato**

Panel in satin methacrylate / Platte aus  
satiniertem Methacrylat / Panneau en  
méthacrylate satiné

# SEGNAPASSI

## Pathmarkers

### Orientierungsbeleuchtung

### Balisages encastrés

**PATENTED**

CRISTALY®

made in Italy

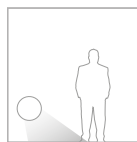

CASAMBI Pg.408

Art. 4195A - Private house - Volos, Greece



#### DATI TECNICI / TECHNICAL DATA

4195A-3004	LED 1.1W-24Vdc-100lm-3000°K-CRI85
4195A-2704	LED 1.1W-24Vdc-95lm-2700°K-CRI85
4195A-4004	LED 1.1W-24Vdc-106lm-4000°K-CRI85
026.258	DRIVER ON/OFF 12W 24V
026.259	DRIVER ON/OFF 36W 24V
026.260	DRIVER ON/OFF 60W 24V
026.219	DRIVER DIM PUSH/0-10V/DALI 21.6W 24V
026.209	DRIVER DIM PUSH/1-10V 60W 24V

#### ACCESSORI / ACCESSORIES

023.479	Controcassa per muratura / Housing box for brickwork / Einbaugehäuse für Betonwand / Boîtier pour béton/briques [210x260x90mm]
099.142	Pg.415 Kit emergenza / Emergency Kit

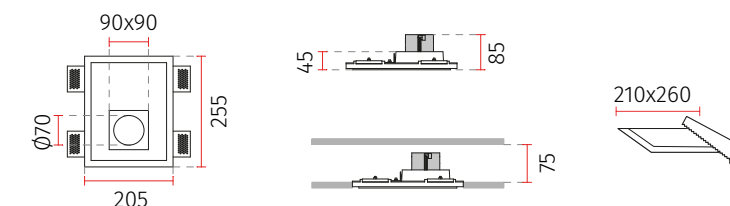

4195A



1,8 Kg

#### 4195A:

Faretto da incasso in CRISTALY®, con LED incluso, progettato per installazione integrata della presa elettrica (scatola, supporto e frutto non incluso nella confezione)

EN Recessed spotlight made of CRISTALY® with LED included, suitable for installation of the recessed electrical socket (junction box, support and socket are not included in the supply)

DE Einbaustrahler aus CRISTALY® inkl. LED, geeignet zum Einbau der Steckdose (Anschlussdose, Halter und Steckdose sind nicht im Lieferumfang enthalten)

FR Spot encastré en CRISTALY®, avec LED incluse, adapté à l'installation de la prise de courant (boîte de jonction, support et prise de courant non fournis)

#### DATI TECNICI / TECHNICAL DATA

4195B-3004	LED 1.1W-24Vdc-100lm-3000°K-CRI85
4195B-2704	LED 1.1W-24Vdc-95lm-2700°K-CRI85
4195B-4004	LED 1.1W-24Vdc-106lm-4000°K-CRI85
026.258	DRIVER ON/OFF 12W 24V
026.259	DRIVER ON/OFF 36W 24V
026.260	DRIVER ON/OFF 60W 24V
026.219	DRIVER DIM PUSH/0-10V/DALI 21.6W 24V
026.209	DRIVER DIM PUSH/1-10V 60W 24V

#### ACCESSORI / ACCESSORIES

023.479	Controcassa per muratura / Housing box for brickwork / Einbaugehäuse für Betonwand / Boîtier pour béton/briques [210x260x90mm]
099.142	Pg.415 Kit emergenza / Emergency Kit

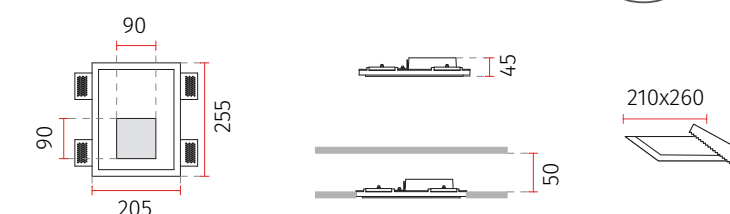

4195B



1,9 Kg

#### 4195B:

Faretto da incasso in CRISTALY®, con LED incluso, senza predisposizione per presa elettrica

EN Recessed spotlight made of CRISTALY®, with LED included, without hole for the electrical socket

DE Einbaustrahler aus CRISTALY®, inkl. LED, ohne Loch für die Steckdose

FR Spot encastré en CRISTALY®, avec LED incluse, sans trou pour la prise de courant

**SEGNAPASSI**  
Pathmarkers  
Orientierungsbeleuchtung  
Balisages encastrés

**PATENTED**

CRISTALY®

made in Italy

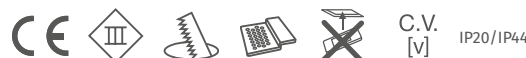
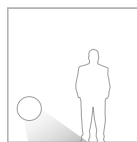

C.V. [V] IP20/IP44

CASAMBI Pg.408

Art. 4195C



**DATI TECNICI / TECHNICAL DATA**

4195C-3004	LED 1.1W-24Vdc-100lm-3000°K-CRI85
4195C-2704	LED 1.1W-24Vdc-95lm-2700°K-CRI85
4195C-4004	LED 1.1W-24Vdc-106lm-4000°K-CRI85
026.258	DRIVER ON/OFF 12W 24V
026.259	DRIVER ON/OFF 36W 24V
026.260	DRIVER ON/OFF 60W 24V
026.219	DRIVER DIM PUSH/0-10V/DALI 21.6W 24V
026.209	DRIVER DIM PUSH/1-10V 60W 24V

**ACCESSORI / ACCESSORIES**

023.479	Controcassa per muratura / Housing box for brickwork / Einbaugehäuse für Betonwand / Boîtier pour béton/briques [210x260x90mm]
099.142	Pg.415 Kit emergenza / Emergency Kit

NEW **4195C**

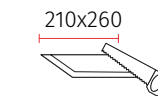
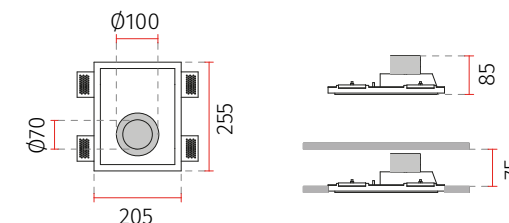

**4195C:**

Faretto da incasso in CRISTALY®, con LED incluso, progettato per installazione integrata della presa elettrica (scatola, supporto e frutto non incluso nella confezione)

EN Recessed spotlight made of CRISTALY® with LED included, suitable for installation of the recessed electrical socket (junction box, support and socket are not included in the supply)

DE Einbaustrahler aus CRISTALY® inkl. LED, geeignet zum Einbau der Steckdose (Anschlussdose, Halter und Steckdose sind nicht im Lieferumfang enthalten)

FR Spot encastré en CRISTALY®, avec LED incluse, adapté à l'installation de la prise de courant (boîte de jonction, support et prise de courant non fournis)

**DATI TECNICI / TECHNICAL DATA**

4195D-3004	LED 1.1W-24Vdc-100lm-3000°K-CRI85
4195D-2704	LED 1.1W-24Vdc-95lm-2700°K-CRI85
4195D-4004	LED 1.1W-24Vdc-106lm-4000°K-CRI85
026.258	DRIVER ON/OFF 12W 24V
026.259	DRIVER ON/OFF 36W 24V
026.260	DRIVER ON/OFF 60W 24V
026.219	DRIVER DIM PUSH/0-10V/DALI 21.6W 24V
026.209	DRIVER DIM PUSH/1-10V 60W 24V

**ACCESSORI / ACCESSORIES**

023.479	Controcassa per muratura / Housing box for brickwork / Einbaugehäuse für Betonwand / Boîtier pour béton/briques [210x260x90mm]
099.142	Pg.415 Kit emergenza / Emergency Kit

NEW **4195D**

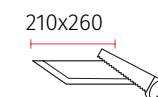
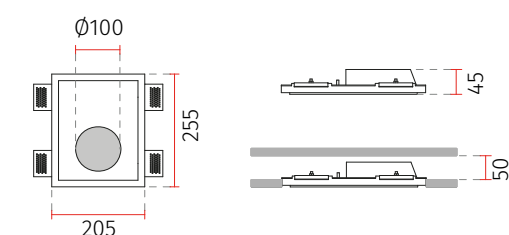

**4195D:**

Faretto da incasso in CRISTALY®, con LED incluso, senza predisposizione per presa elettrica

EN Recessed spotlight made of CRISTALY®, with LED included, without hole for the electrical socket

DE Einbaustrahler aus CRISTALY®, inkl. LED, ohne Loch für die Steckdose

FR Spot encastré en CRISTALY®, avec LED incluse, sans trou pour la prise de courant

# SEGNAPASSI

## Pathmarkers

### Orientierungsbeleuchtung

### Balisages encastrés

CRISTALY<sup>®</sup> made in Italy



CASAMBI Pg.408

Art. 2466B / 4201 / 2369A / 4174 - Private house - London, UK  
Arch. Hestia Developments



IT Misure espresse in mm, tolleranza +/- 1-2 mm. L'azienda si riserva la facoltà di apportare variazioni di dati caratteristici, materiali, design, stili, tonalità, senza alcun preavviso.  
EN Measures in mm, tolerance +/- 1/2 mm. The company reserves the right to carry out variations to technical details, materials, design, style, colors with no previous notice.

#### DATI TECNICI / TECHNICAL DATA

4198-3000	LED 2W-24Vdc-200lm-3000°K-CRI90
4198-2700	LED 2W-24Vdc-190lm-2700°K-CRI90
4198-4000	LED 2W-24Vdc-210lm-4000°K-CRI90
026.258	DRIVER ON/OFF 12W 24V
026.259	DRIVER ON/OFF 36W 24V
026.260	DRIVER ON/OFF 60W 24V
026.219	DRIVER DIM PUSH/0-10V/DALI 21.6W 24V
026.209	DRIVER DIM PUSH/1-10V 60W 24V

#### ACCESSORI / ACCESSORIES

023.411	Controcassa per muratura / Housing box for brickwork / Einbaugehäuse für Betonwand / Boîtier pour béton/briques [105x115x70mm]
099.142	Pg.415 Kit emergenza / Emergency Kit

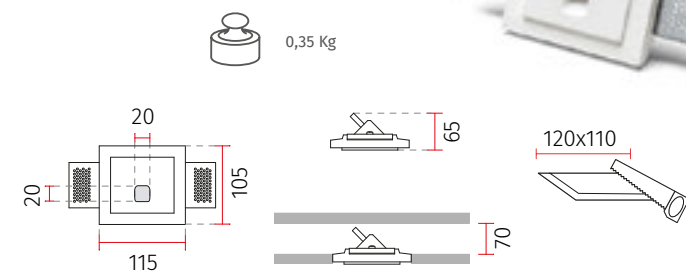

# 4198

#### DATI TECNICI / TECHNICAL DATA

4201-3000	LED 2W-24Vdc-200lm-3000°K-CRI90
4201-2700	LED 2W-24Vdc-190lm-2700°K-CRI90
4201-4000	LED 2W-24Vdc-210lm-4000°K-CRI90
026.258	DRIVER ON/OFF 12W 24V
026.259	DRIVER ON/OFF 36W 24V
026.260	DRIVER ON/OFF 60W 24V
026.219	DRIVER DIM PUSH/0-10V/DALI 21.6W 24V
026.209	DRIVER DIM PUSH/1-10V 60W 24V

#### ACCESSORI / ACCESSORIES

023.411	Controcassa per muratura / Housing box for brickwork / Einbaugehäuse für Betonwand / Boîtier pour béton/briques [105x115x70mm]
099.142	Pg.415 Kit emergenza / Emergency Kit

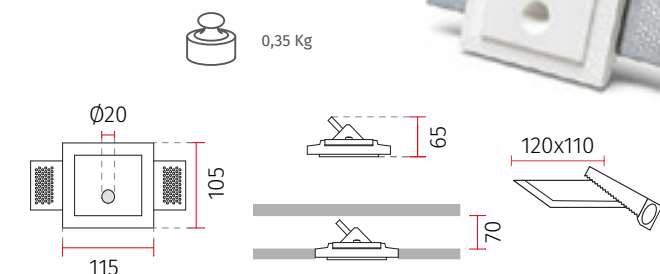

# 4201

#### DATI TECNICI / TECHNICAL DATA

4202-3000	LED 2W-24Vdc-200lm-3000°K-CRI90
4202-2700	LED 2W-24Vdc-190lm-2700°K-CRI90
4202-4000	LED 2W-24Vdc-210lm-4000°K-CRI90
026.258	DRIVER ON/OFF 12W 24V
026.259	DRIVER ON/OFF 36W 24V
026.260	DRIVER ON/OFF 60W 24V
026.219	DRIVER DIM PUSH/0-10V/DALI 21.6W 24V
026.209	DRIVER DIM PUSH/1-10V 60W 24V

#### ACCESSORI / ACCESSORIES

023.411	Controcassa per muratura / Housing box for brickwork / Einbaugehäuse für Betonwand / Boîtier pour béton/briques [105x115x70mm]
099.142	Pg.415 Kit emergenza / Emergency Kit

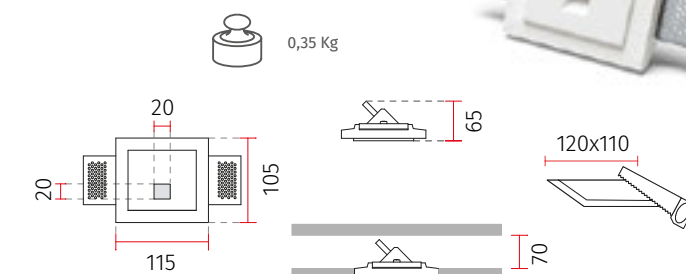

# 4202

#### DATI TECNICI / TECHNICAL DATA

4204B-3000	LED 2W-24Vdc-200lm-3000°K-CRI90
4204B-2700	LED 2W-24Vdc-190lm-2700°K-CRI90
4204B-4000	LED 2W-24Vdc-210lm-4000°K-CRI90
026.258	DRIVER ON/OFF 12W 24V
026.259	DRIVER ON/OFF 36W 24V
026.260	DRIVER ON/OFF 60W 24V
026.219	DRIVER DIM PUSH/0-10V/DALI 21.6W 24V
026.209	DRIVER DIM PUSH/1-10V 60W 24V

#### ACCESSORI / ACCESSORIES

023.499	Controcassa per muratura / Housing box for brickwork / Einbaugehäuse für Betonwand / Boîtier pour béton/briques [95x255x65mm]
099.142	Pg.415 Kit emergenza / Emergency Kit

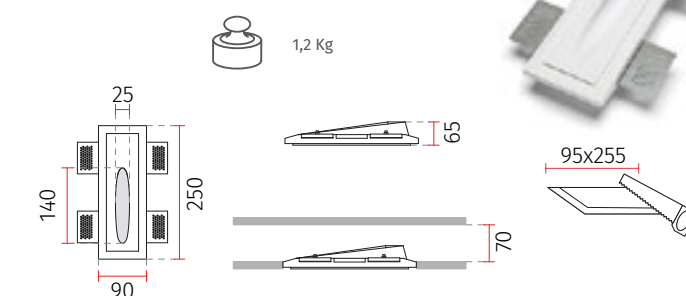

# 4204B

DE Die Maße sind in mm, mit einer Tolleranz von +/- 1-2 mm ausgedrückt, Die Firma behält sich das Recht vor ohne Voranmeldung Änderungen an den Werkstoffen, am Design, am Stil und an der Färbung vorzunehmen.  
FR Mesures en mm, tolérance +/- 1/2 mm. La société se réserve le droit de modifier sans préavis les détails techniques, les matériaux, le design, le style et les couleurs.

# COMPLETA L'ARREDAMENTO

**MAGNETICO**  
MAGNETIC

**SICURO**  
SAFE

**FISSAGGIO RAPIDO**  
QUICK FIXING



Non solo incasso o installazione murale tradizionale. 9010 propone una nuova serie di prodotti compatibili ad essere fissati su scatola per muratura tipo 503 o 504, per completare l'offerta di installazione in qualsiasi situazione.

ENG Not just recessed or traditional wall installation. 9010 proposes a new series of compatible products to be fixed on 503 or 504-type masonry box, to complete the installation offer in any situation.

DE Nicht nur traditionelle Einbau- oder Wandleuchten. 9010 bietet eine neue Produktreihe an, die zur Befestigung an Einbaueinheiten Typ 503 oder 504 geeignet ist, um das für jede Situation geeignete Installationsangebot abzurunden.

FR Pas seulement un encastrement ou une installation murale traditionnelle. 9010 propose une nouvelle série de produits à fixer sur un boîtier pour maçonnerie de type 503 ou 504, pour compléter l'offre d'installation dans toutes les situations.

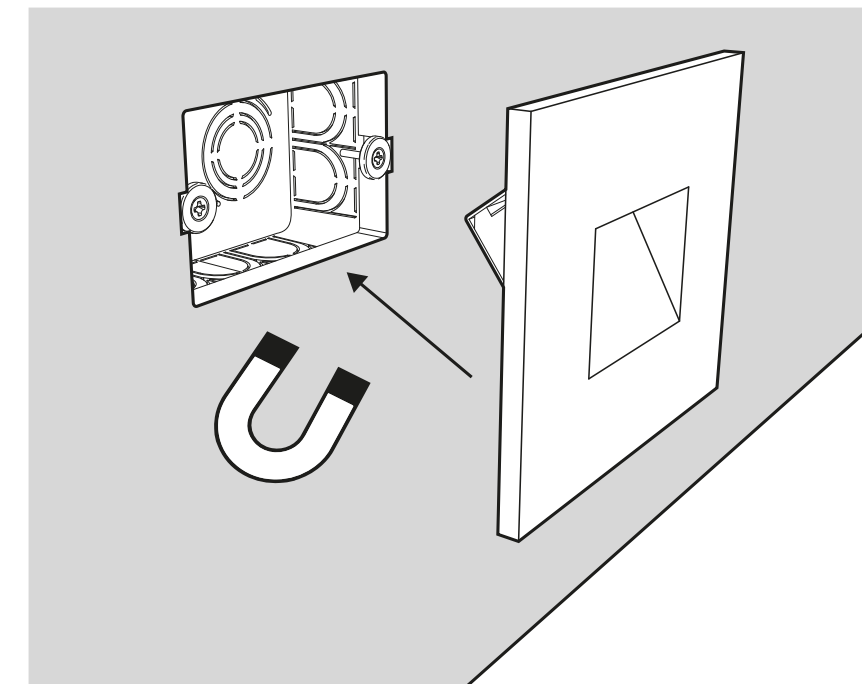

- 1 **Fissaggio rapido tramite sistema magnetico esclusivo 9010 (brevetto in corso)**  
*Quick fixing using an exclusive 9010 magnetic system (patent pending)*  
*Schnelle Befestigung mit exklusivem Magnetsystem 9010 (Patentverfahren läuft)*  
*Fixation rapide avec un système magnétique exclusif 9010 (brevet en cours).*
- 2 **Bassa tensione per massima sicurezza**  
*Low voltage for maximum safety*  
*Niederspannung für höchste Sicherheit*  
*Basse tension pour une sécurité maximale*
- 3 **Funzionamento in 24V con collegamento in parallelo**  
*24V operation with parallel connection*  
*24V-Betrieb mit Parallelschaltung*  
*Fonctionnement en 24V avec connexion en parallèle*
- 4 **Possibilità di essere colorati con pittura murale**  
*Can be coloured with wall painting*  
*Mit Wandfarbe lackierbar*  
*Possibilité de coloration avec de la peinture pour bâtiment*

# SEGNAPASSI

## Pathmarkers

### Orientierungsbeleuchtung

### Balisages encastrés

**PATENT  
PENDING**

CRISTALY®

made in Italy



Art. 4205A



IT Misure espresse in mm, tolleranza +/- 1-2 mm. L'azienda si riserva la facoltà di apportare variazioni di dati caratteristici, materiali, design, stili, tonalità, senza alcun preavviso.  
EN Measures in mm, tolerance +/- 1/2 mm. The company reserves the right to carry out variations to technical details, materials, design, style, colors with no previous notice.

#### DATI TECNICI / TECHNICAL DATA

4205A-3004	LED 1.1W-24Vdc-100lm-3000°K-CRI85
4205A-2704	LED 1.1W-24Vdc-95lm-2700°K-CRI85
4205A-4004	LED 1.1W-24Vdc-106lm-4000°K-CRI85
026.258	DRIVER ON/OFF 12W 24V
026.259	DRIVER ON/OFF 36W 24V
026.260	DRIVER ON/OFF 60W 24V
026.219	DRIVER DIM PUSH/0-10V/DALI 21.6W 24V
026.209	DRIVER DIM PUSH/1-10V 60W 24V

#### ACCESSORI / ACCESSORIES

099.142	Pg.415 Kit emergenza / Emergency Kit
---------	--------------------------------------

**NEW 4205A**



0,3 Kg

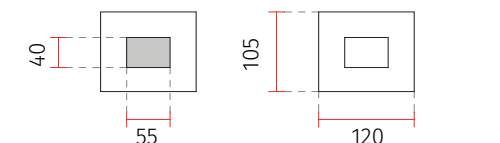

#### DATI TECNICI / TECHNICAL DATA

4205B-3000	LED 2W-24Vdc-200lm-3000°K-CRI90
4205B-2700	LED 2W-24Vdc-190lm-2700°K-CRI90
4205B-4000	LED 2W-24Vdc-210lm-4000°K-CRI90
026.258	DRIVER ON/OFF 12W 24V
026.259	DRIVER ON/OFF 36W 24V
026.260	DRIVER ON/OFF 60W 24V
026.219	DRIVER DIM PUSH/0-10V/DALI 21.6W 24V
026.209	DRIVER DIM PUSH/1-10V 60W 24V

#### ACCESSORI / ACCESSORIES

099.142	Pg.415 Kit emergenza / Emergency Kit
---------	--------------------------------------

**NEW 4205B**



0,3 Kg

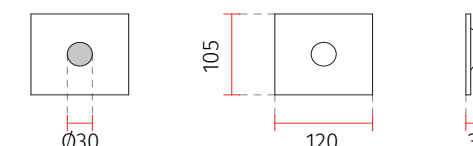

#### DATI TECNICI / TECHNICAL DATA

4205C-3000	LED 2W-24Vdc-200lm-3000°K-CRI90
4205C-2700	LED 2W-24Vdc-190lm-2700°K-CRI90
4205C-4000	LED 2W-24Vdc-210lm-4000°K-CRI90
026.258	DRIVER ON/OFF 12W 24V
026.259	DRIVER ON/OFF 36W 24V
026.260	DRIVER ON/OFF 60W 24V
026.219	DRIVER DIM PUSH/0-10V/DALI 21.6W 24V
026.209	DRIVER DIM PUSH/1-10V 60W 24V

#### ACCESSORI / ACCESSORIES

099.142	Pg.415 Kit emergenza / Emergency Kit
---------	--------------------------------------

**NEW 4205C**



0,35 Kg

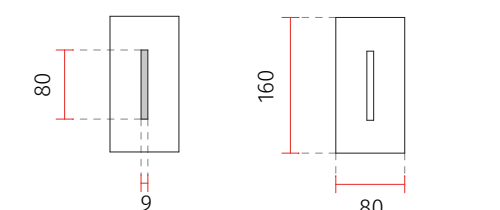

DE Die Masse sind in mm, mit einer Tolleranz von +/- 1-2 mm ausgedrückt, Die Firma behält sich das Recht vor ohne Voranmeldung Änderungen an den Werkstoffen, am Design, am Stil und an der Färbung vorzunehmen.  
FR Mesures en mm, tolérance +/- 1/2 mm. La société se réserve le droit de modifier sans préavis les détails techniques, les matériaux, le design, le style et les couleurs.

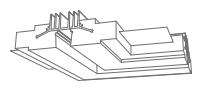
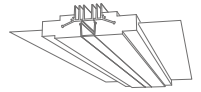
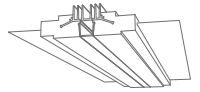
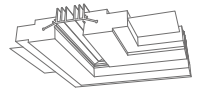
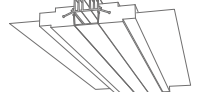
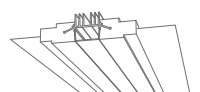
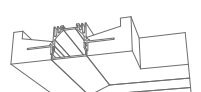
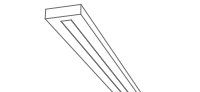
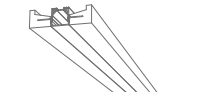
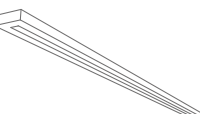
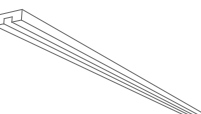
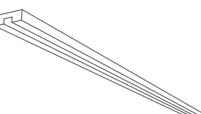
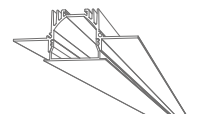
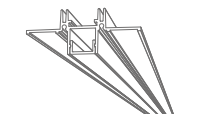
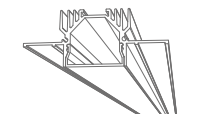
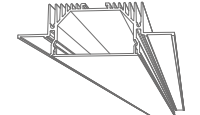
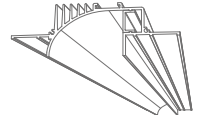
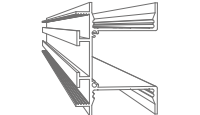
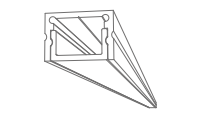
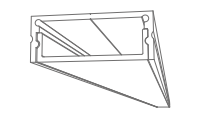
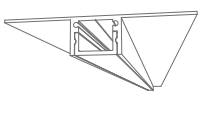
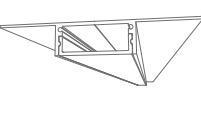
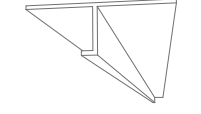

**PROFILI**  
 Profiles  
 Profile  
 Profilés

					
4189K p.322	4189A p.323	4189B p.323	4189C p.323	4190K p.324	4190A p.325
					
4190B p.325	4190C p.325	8956K p.326	8956A p.327	8956B p.327	8956C p.327
					
<b>NEW</b> 8956D p.329	<b>NEW</b> 8956E p.329	<b>NEW</b> 8956F p.329	P001 p.331	P002 p.333	P003 p.335
					
P004 p.337	P005 p.339	P007 p.341	P009 p.345	<b>NEW</b> P010 p.347	<b>NEW</b> P011 p.349
					
<b>NEW</b> P012 p.351	<b>NEW</b> P013 p.353	<b>NEW</b> P015 p.355			

# PROFILI

## Profiles

### Profile

### Profilés

CRISTALY®  
ALUMITE®  
made in Italy

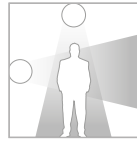

Art. 4189 - Private house - Stuttgart, Germany



Schermo opalino  
Opal plastic cover  
Abdeckung in Opalen-Kunststoff  
Diffuseur en plastique opale

Accessorio 4189K - connessione a L / Accessory 4189K - L connection /  
Zubehöre 4189K - L Verbindungsteile / Accessoires 4189K - Connexion à L :



# 4189K

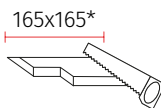
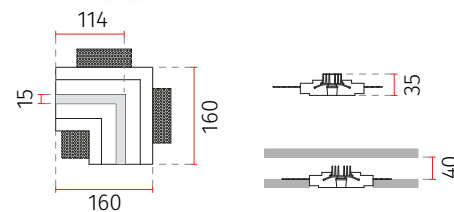

DATI TECNICI / TECHNICAL DATA	
4189K-00	Senza parte elettrica / Without electrical part / Ohne elektrischen Teil / Sans partie électrique
ACCESSORI / ACCESSORIES	
LED Strip	Pg. 398
029.004	Ricambio schermo opalino / Opal plastic cover replacement part / Abdeckung in Opalen-Kunststoff Ersatzteil / Diffuseur opal pièce de rechange

\*= Effettuare il foro ad "L" / Carry out an "L" shape cut /  
Führen Sie einen "L"-Formschnitt durch / Effectuer une coupe à "L"

IT I profili vengono forniti con tolleranza +/- 10 mm. Per misure precise si consiglia di ordinare il taglio a misura. L'azienda si riserva la facoltà di apportare variazioni di dati caratteristici, materiali, design, stili, tonalità, senza alcun preavviso.  
EN The profiles are supplied with a tolerance +/- 10 mm. For precise measures, we suggest to order custom cut profiles. The company reserves the right to carry out variations to technical details, materials, design, style, colors with no previous notice.

DATI TECNICI / TECHNICAL DATA	
4189A-00	L 500 - Senza parte elettrica / Without electrical part / Ohne elektrischen Teil / Sans partie électrique
ACCESSORI / ACCESSORIES	
LED Strip	Pg. 398
029.004	Ricambio schermo opalino / Opal plastic cover replacement part / Abdeckung in Opalen-Kunststoff Ersatzteil / Diffuseur opal pièce de rechange
TGC	Taglio a misura / Custom Cut / Zuschnitt / Coupe personnalisée
4189K-00	Particolare ad angolo / Corner accessory / Ecke Zubehörteile / Accessoire Angle

LED= MAX 30W/m

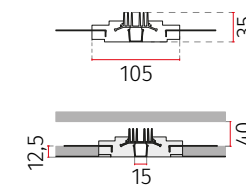
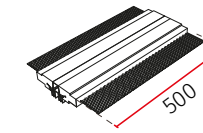

# 4189A



\*= Misure comprensive di parti terminali / Terminal parts are included in measures / Endkappen sind in der Abmessung eingeschlossen / Les tête de fermetures sont comprises dans les mesures

DATI TECNICI / TECHNICAL DATA	
4189B-00	L 1000 - Senza parte elettrica / Without electrical part / Ohne elektrischen Teil / Sans partie électrique
ACCESSORI / ACCESSORIES	
LED Strip	Pg. 398
029.004	Ricambio schermo opalino / Opal plastic cover replacement part / Abdeckung in Opalen-Kunststoff Ersatzteil / Diffuseur opal pièce de rechange
TGC	Taglio a misura / Custom Cut / Zuschnitt / Coupe personnalisée
4189K-00	Particolare ad angolo / Corner accessory / Ecke Zubehörteile / Accessoire Angle

LED= MAX 30W/m

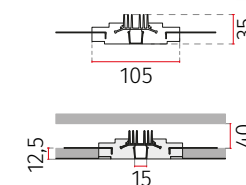
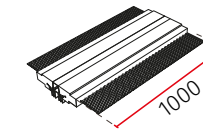

# 4189B

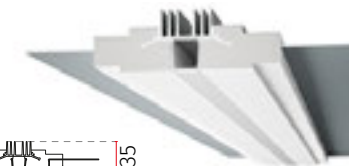

\*= Misure comprensive di parti terminali / Terminal parts are included in measures / Endkappen sind in der Abmessung eingeschlossen / Les tête de fermetures sont comprises dans les mesures

DATI TECNICI / TECHNICAL DATA	
4189C-00	L 1500 - Senza parte elettrica / Without electrical part / Ohne elektrischen Teil / Sans partie électrique
ACCESSORI / ACCESSORIES	
LED Strip	Pg. 398
029.004	Ricambio schermo opalino / Opal plastic cover replacement part / Abdeckung in Opalen-Kunststoff Ersatzteil / Diffuseur opal pièce de rechange
TGC	Taglio a misura / Custom Cut / Zuschnitt / Coupe personnalisée
4189K-00	Particolare ad angolo / Corner accessory / Ecke Zubehörteile / Accessoire Angle

LED= MAX 30W/m

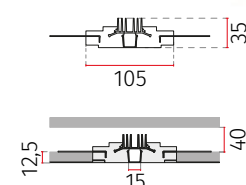
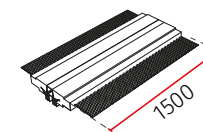

# 4189C

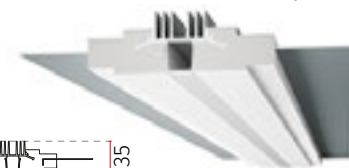

\*= Misure comprensive di parti terminali / Terminal parts are included in measures / Endkappen sind in der Abmessung eingeschlossen / Les tête de fermetures sont comprises dans les mesures

## 4189A - 4189B - 4189C:

Nella confezione di ogni singolo profilo viene fornito:  
- Profilo in CRISTALY® con dissipatore in ALUMITE® incorporato;  
- 2 Testate di chiusura in CRISTALY® da incollare ai capi dei profili terminali;  
- Copertura in materiale plastico opalino per la lunghezza totale necessaria alla realizzazione del progetto.  
STRIP LED 9010 DA ORDINARE SEPARATAMENTE.

EN Included in the packaging of each profile:  
- CRISTALY® profile with included ALUMITE® heat diffuser;  
- 2 CRISTALY® end caps to be glued to the heads of the terminal profiles;  
- Opal plastic cover supplied for the total required length of the project.  
STRIP LED 9010 TO BE ORDERED SEPARATELY.

DE In der Verpackung der einzelnen Profile ist inbegriffen:  
- CRISTALY® Profil mit eingebautem ALUMITE® Wärmeableiter;  
- 2 CRISTALY® Endkappen, die auf die Enden der Profile aufgeklebt werden;  
- Die Abdeckung in Opalin-Kunststoff wird für die benötigte Gesamtlänge geliefert.  
LED STRIP 9010 SEPARAT ZU BESTELLEN.

FR Dans le colisage de chaque profilé est inclus:  
- Profilé en CRISTALY® avec Dissipateur en ALUMITE®;  
- 2 parties terminaux en CRISTALY® à coller aux extrémités des profils;  
- Couverture en plastique opale pour la longueur totale nécessaire à la réalisation du projet;  
RUBAN LED 9010 A' COMMANDER SEPAREMENT.

DE Die Profile werden mit einer Toleranz von +/- 10 mm geliefert. Für genaue Abmessungen empfehlen wir den Zuschnitt zu bestellen. Die Firma behält sich das Recht vor ohne Voranmeldung Änderungen an den Werkstoffen, am Design, am Stil und an der Färbung vorzunehmen.  
FR Les profilés sont fournis avec tolérance de +/- 10 mm. Pour des mesures précises, nous vous suggérons de commander coupe personnalisée. La société se réserve le droit de modifier sans préavis les détails techniques, les matériaux, le design, le style et les couleurs.

# PROFILI

## Profiles

### Profile

### Profilés

CRISTALY®  
ALUMITE®  
made in Italy

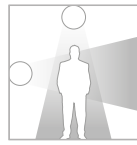

Art. 4190 - Private house - Vicenza, Italy  
Arch. Stefano Lucato



Schermo opalino  
Opal plastic cover  
Abdeckung in Opalen-Kunststoff  
Diffuseur en plastique opale

Accessorio 4190K - connessione a L / Accessory 4190K - L connection /  
Zubehöre 4190K - L Verbindungsteile / Accessoires 4190K - Connexion à L :



## 4190K

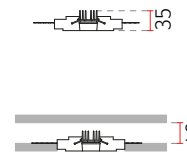
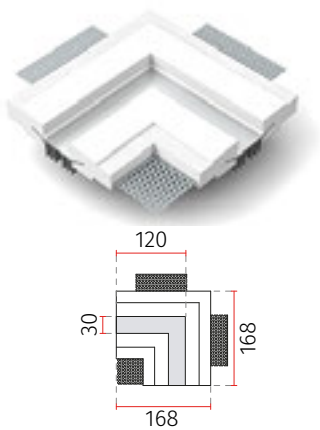

\*= Effettuare il foro ad "L" / Carry out an "L" shape cut /  
Führen Sie einen "L"-Formschnitt durch / Effectuer une coupe à "L"

DATI TECNICI / TECHNICAL DATA	
4190K-00	Senza parte elettrica / Without electrical part / Ohne elektrischen Teil / Sans partie électrique
ACCESSORI / ACCESSORIES	
LED Strip	Pg. 398
029.005	Ricambio schermo opalino / Opal plastic cover replacement part / Abdeckung in Opalen-Kunststoff Ersatzteil / Diffuseur opal pièce de rechange

IT I profili vengono forniti con tolleranza +/- 10 mm. Per misure precise si consiglia di ordinare il taglio a misura. L'azienda si riserva la facoltà di apportare variazioni di dati caratteristici, materiali, design, stili, tonalità, senza alcun preavviso.  
EN The profiles are supplied with a tolerance +/- 10 mm. For precise measures, we suggest to order custom cut profiles. The company reserves the right to carry out variations to technical details, materials, design, style, colors with no previous notice.

DATI TECNICI / TECHNICAL DATA	
4190A-00	L 500 - Senza parte elettrica / Without electrical part / Ohne elektrischen Teil / Sans partie électrique
ACCESSORI / ACCESSORIES	
LED Strip	Pg. 398
029.005	Ricambio schermo opalino / Opal plastic cover replacement part / Abdeckung in Opalen-Kunststoff Ersatzteil / Diffuseur opal pièce de rechange
TGC	Taglio a misura / Custom Cut / Zuschnitt / Coupe personnalisée
4190K-00	Particolare ad angolo / Corner accessory / Ecke Zubehörteile / Accessoire Angle

LED= MAX 30W/m

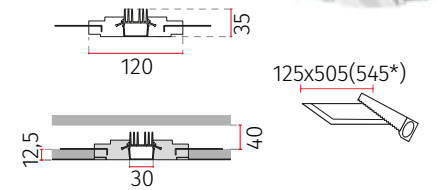
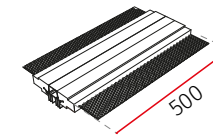

\*= Misure comprensive di parti terminali / Terminal parts are included in measures / Endkappen sind in der Abmessung eingeschlossen / Les tête de fermetures sont comprises dans les mesures

## 4190A

DATI TECNICI / TECHNICAL DATA	
4190B-00	L 1000 - Senza parte elettrica / Without electrical part / Ohne elektrischen Teil / Sans partie électrique
ACCESSORI / ACCESSORIES	
LED Strip	Pg. 398
029.005	Ricambio schermo opalino / Opal plastic cover replacement part / Abdeckung in Opalen-Kunststoff Ersatzteil / Diffuseur opal pièce de rechange
TGC	Taglio a misura / Custom Cut / Zuschnitt / Coupe personnalisée
4190K-00	Particolare ad angolo / Corner accessory / Ecke Zubehörteile / Accessoire Angle

LED= MAX 30W/m

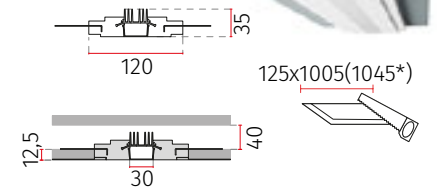
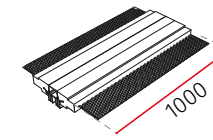

\*= Misure comprensive di parti terminali / Terminal parts are included in measures / Endkappen sind in der Abmessung eingeschlossen / Les tête de fermetures sont comprises dans les mesures

## 4190B

DATI TECNICI / TECHNICAL DATA	
4190C-00	L 1500 - Senza parte elettrica / Without electrical part / Ohne elektrischen Teil / Sans partie électrique
ACCESSORI / ACCESSORIES	
LED Strip	Pg. 398
029.005	Ricambio schermo opalino / Opal plastic cover replacement part / Abdeckung in Opalen-Kunststoff Ersatzteil / Diffuseur opal pièce de rechange
TGC	Taglio a misura / Custom Cut / Zuschnitt / Coupe personnalisée
4190K-00	Particolare ad angolo / Corner accessory / Ecke Zubehörteile / Accessoire Angle

LED= MAX 30W/m

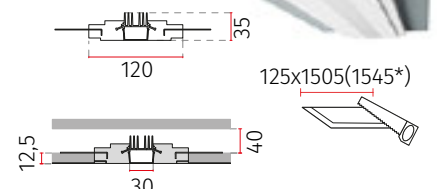
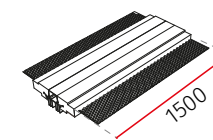

\*= Misure comprensive di parti terminali / Terminal parts are included in measures / Endkappen sind in der Abmessung eingeschlossen / Les tête de fermetures sont comprises dans les mesures

## 4190C

### 4190A - 4190B - 4190C:

Nella confezione di ogni singolo profilo viene fornito:  
- Profilo in CRISTALY® con dissipatore in ALUMITE® incorporato;  
- 2 Testate di chiusura in CRISTALY® da incollare ai capi dei profili terminali;  
- Copertura in materiale plastico opalino per la lunghezza totale necessaria alla realizzazione del progetto.  
STRIP LED 9010 DA ORDINARE SEPARATAMENTE.

EN Included in the packaging of each profile:  
- CRISTALY® profile with included ALUMITE® heat diffuser;  
- 2 CRISTALY® end caps to be glued to the heads of the terminal profiles;  
- Opal plastic cover supplied for the total required length of the project.  
STRIP LED 9010 TO BE ORDERED SEPARATELY.

DE In der Verpackung der einzelnen Profile ist inbegriffen:  
- CRISTALY® Profil mit eingebautem ALUMITE® Wärmeableiter;  
- 2 CRISTALY® Endkappen, die auf die Enden der Profile aufgeklebt werden;  
- Die Abdeckung in Opalin-Kunststoff wird für die benötigte Gesamtlänge geliefert.  
LED STRIP 9010 SEPARAT ZU BESTELLEN.

FR Dans le colisage de chaque profilé est inclus:  
- Profilé en CRISTALY® avec Dissipateur en ALUMITE®;  
- 2 parties terminaux en CRISTALY® à coller aux extrémités des profils;  
- Couverture en plastique opale pour la longueur totale nécessaire à la réalisation du projet;  
RUBAN LED 9010 A' COMMANDER SEPAREMENT.

DE Die Profile werden mit einer Toleranz von +/- 10 mm geliefert. Für genaue Abmessungen empfehlen wir den Zuschnitt zu bestellen. Die Firma behält sich das Recht vor ohne Voranmeldung Änderungen an den Werkstoffen, am Design, am Stil und an der Färbung vorzunehmen.  
FR Les profilés sont fournis avec tolérance de +/- 10 mm. Pour des mesures précises, nous vous suggérons de commander coupe personnalisée. La société se réserve le droit de modifier sans préavis les détails techniques, les matériaux, le design, le style et les couleurs.

# PROFILI

## Profiles

### Profile

### Profilés

CRISTALY®

made in Italy

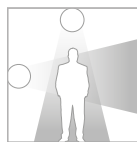

IP20

Art. 8956



Senza testata di chiusura  
Without end caps  
Ohne Endkappen  
Sans tête de fermeture



Con testata di chiusura  
With end caps  
Mit Endkappen  
Avec tête de fermeture

Accessorio 8956K - connessione a L / Accessory 8956K - L connection /  
Zubehöre 8956K - L Verbindungsteile / Accessoires 8956K - Connexion à L :

## 8956K



1,05 Kg

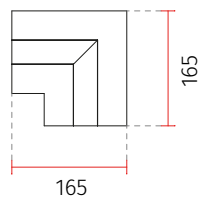

DATI TECNICI / TECHNICAL DATA	
8956K-00	Senza parte elettrica / Without electrical part / Ohne elektrischen Teil / Sans partie électrique
ACCESSORI / ACCESSORIES	
LED Strip	Pg. 398
029.012.300	3000mm - Ricambio schermo opalino / Opal plastic cover replacement part / Abdeckung in Opalen-Kunststoff Ersatzteil / Diffuseur opal pièce de rechange

## 8956A



DATI TECNICI / TECHNICAL DATA	
8956A-00	L 1500 - Con Testate / With endcaps / Mit Endkappen / Avec tête de fermeture
ACCESSORI / ACCESSORIES	
LED Strip	Pg. 398
029.012.300	3000mm - Ricambio schermo opalino / Opal plastic cover replacement part / Abdeckung in Opalen-Kunststoff Ersatzteil / Diffuseur opal pièce de rechange
8956K-00	Particolare ad angolo / Corner accessory / Ecke Zubehörteile / Accessoire Angle

LED= MAX 26W/m

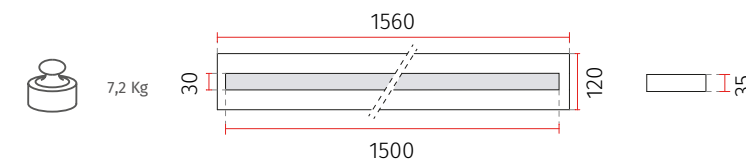

## 8956B



DATI TECNICI / TECHNICAL DATA	
8956B-00	L 1500 - Aperta da un lato / One side open / Eine Seite geöffnet / Un côté ouvert
ACCESSORI / ACCESSORIES	
LED Strip	Pg. 398
029.012.300	3000mm - Ricambio schermo opalino / Opal plastic cover replacement part / Abdeckung in Opalen-Kunststoff Ersatzteil / Diffuseur opal pièce de rechange
TGC	Taglio a misura / Custom Cut / Zuschnitt / Coupe personnalisée
8956K-00	Particolare ad angolo / Corner accessory / Ecke Zubehörteile / Accessoire Angle

LED= MAX 26W/m

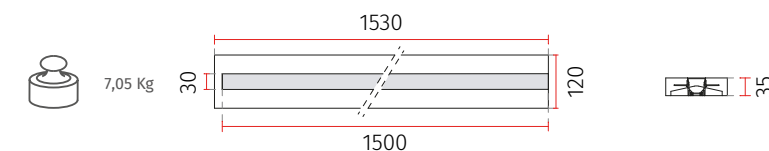

## 8956C



DATI TECNICI / TECHNICAL DATA	
8956C-00	L 1500 - Senza Testate / Without endcaps / Ohne Endkappen / Sans tête de fermeture
ACCESSORI / ACCESSORIES	
LED Strip	Pg. 398
029.012.300	3000mm - Ricambio schermo opalino / Opal plastic cover replacement part / Abdeckung in Opalen-Kunststoff Ersatzteil / Diffuseur opal pièce de rechange
TGC	Taglio a misura / Custom Cut / Zuschnitt / Coupe personnalisée
8956K-00	Particolare ad angolo / Corner accessory / Ecke Zubehörteile / Accessoire Angle

LED= MAX 26W/m

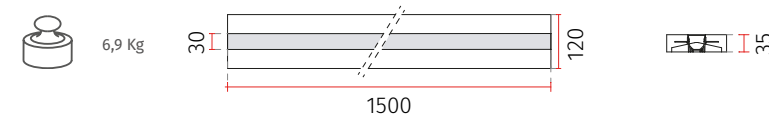

### 8956A - 8956B - 8956C:

Nella confezione di ogni singolo profilo viene fornito:  
- Profilo in CRISTALY®;  
- Schermo in metacrilato opalino goffrato;  
STRIP LED 9010 DA ORDINARE SEPARATAMENTE.

EN Included in the packaging of each profile:  
- CRISTALY® profile;  
- Screen in opal methacrylate;  
STRIP LED 9010 TO BE ORDERED SEPARATELY.

DE In der Verpackung der einzelnen Profile ist inbegriffen:  
- CRISTALY® Profil;  
- Abdeckung aus Opal-Methacrylat;  
LED STRIP 9010 SEPARAT ZU BESTELLEN.

FR Dans le colisage de chaque profilé est inclus:  
- Profilé en CRISTALY®;  
- couverture opale en methacrylate;  
RUBAN LED 9010 A' COMMANDER SEPAREMENT.

**PROFILI**  
Profiles  
Profile  
Profilés

CRISTALY®

made in Italy

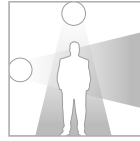

IP20

Art. 8956



**DATI TECNICI / TECHNICAL DATA**

**8956D-00** L 1440 - Con Testate / With endcaps / Mit Endkappen / Avec tête de fermeture

**ACCESSORI / ACCESSORIES**

**LED Strip** Pg. 398  
**029.010.300** L3000 Ricambio schermo opalino / Opal plastic cover replacement part / Abdeckung in Opalen-Kunststoff Ersatzteil / Diffuseur opal pièce de rechange

LED= MAX 18W/m

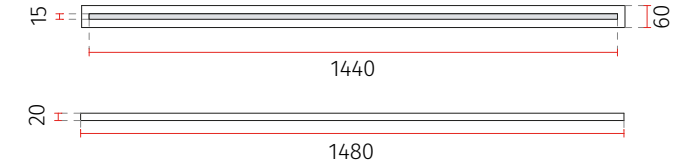

**NEW 8956D**

**DATI TECNICI / TECHNICAL DATA**

**8956E-00** L 1440 - Aperta da un lato / One side open / Eine Seite geöffnet / Un côté ouvert

**ACCESSORI / ACCESSORIES**

**LED Strip** Pg. 398  
**TGC** Taglio a misura / Custom Cut / Zuschnitt / Coupe personnalisée  
**029.010.300** L3000 Ricambio schermo opalino / Opal plastic cover replacement part / Abdeckung in Opalen-Kunststoff Ersatzteil / Diffuseur opal pièce de rechange

LED= MAX 18W/m

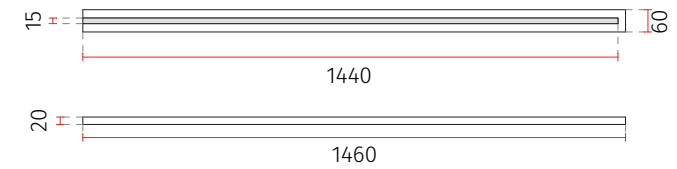

**NEW 8956E**

**DATI TECNICI / TECHNICAL DATA**

**8956F-00** L 1440 - Senza Testate / Without endcaps / Ohne Endkappen / Sans tête de fermeture

**ACCESSORI / ACCESSORIES**

**LED Strip** Pg. 398  
**TGC** Taglio a misura / Custom Cut / Zuschnitt / Coupe personnalisée  
**029.010.300** L3000 Ricambio schermo opalino / Opal plastic cover replacement part / Abdeckung in Opalen-Kunststoff Ersatzteil / Diffuseur opal pièce de rechange

LED= MAX 18W/m

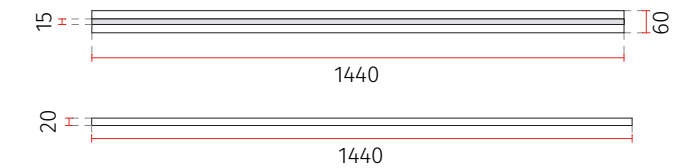

**NEW 8956F**

**8956D - 8956E - 8956F:**

Nella confezione di ogni singolo profilo viene fornito:  
- Profilo in CRISTALY®;  
- Schermo in metacrilato opalino goffrato;  
STRIP LED 9010 DA ORDINARE SEPARATAMENTE.

EN Included in the packaging of each profile:  
- CRISTALY® profile;  
- Screen in opal methacrylate;  
STRIP LED 9010 TO BE ORDERED SEPARATELY.

DE In der Verpackung der einzelnen Profile ist inbegriffen: :  
- CRISTALY® Profil;  
- Abdeckung aus Opal-Methacrylat;  
LED STRIP 9010 SEPARAT ZU BESTELLEN.

FR Dans le colisage de chaque profilé est inclus:  
- Profilé en CRISTALY®;  
- couverture opale en methacrylate;  
RUBAN LED 9010 A' COMMANDER SEPAREMENT.

IT I profili vengono forniti con tolleranza +/- 10 mm. Per misure precise si consiglia di ordinare il taglio a misura. L'azienda si riserva la facoltà di apportare variazioni di dati caratteristici, materiali, design, stili, tonalità, senza alcun preavviso.  
EN The profiles are supplied with a tolerance +/- 10 mm. For precise measures, we suggest to order custom cut profiles. The company reserves the right to carry out variations to technical details, materials, design, style, colors with no previous notice.

DE Die Profile werden mit einer Toleranz von +/- 10 mm geliefert. Für genaue Abmessungen empfehlen wir den Zuschnitt zu bestellen. Die Firma behält sich das Recht vor ohne Voranmeldung Änderungen an den Werkstoffen, am Design, am Stil und an der Färbung vorzunehmen.  
FR Les profilés sont fournis avec tolérance de +/- 10 mm. Pour des mesures précises, nous vous suggérons de commander coupe personnalisée. La société se réserve le droit de modifier sans préavis les détails techniques, les matériaux, le design, le style et les couleurs.

# PROFILI

## Profiles

### Profile

### Profilés

**PATENTED**

ALUMITE®<sub>9010</sub> made in Italy

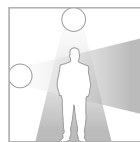

Sistema di incasso rapido (senza stuccatura) / Quick recessing system (Plaster finish is not required) / Schnelles Einbausystem (Ohne Verputz) / Système d'encastrement rapide (Enduit non requis)

Art. P001 - Private house - Bari, Italy  
Arch. Elisa Talamona



#### DATI TECNICI / TECHNICAL DATA

P001B-00	L 1020±10mm - Senza parte elettrica / Without electrical part / Ohne elektrischen Teil / Sans partie électrique / Without electrical part
P001C-00	L 2020±10mm - Senza parte elettrica / Without electrical part / Ohne elektrischen Teil / Sans partie électrique / Without electrical part
P001D-00	L 3020±10mm - Senza parte elettrica / Without electrical part / Ohne elektrischen Teil / Sans partie électrique / Without electrical part

LED= MAX 40W/m

#### ACCESSORI / ACCESSORIES

LED Strip		Pg. 398
TGA		Taglio a misura (45°-90°) / Cut to Size (45°-90°) / Zuschnitt (45°-90°) / Coupé à la taille (45°-90°)
TGP		Taglio a progetto (angoli diversi) / Custom Cut (different angles) / Zuschnitt (andere Winkel) / Coupe personnalisée (autres angles)
023.700		Connessione lineare / Linear connection / Linearen Verbindungsteile / Connexion linéaire
023.701		Connessione "L" / Connection "L" / Verbindungsteile "L" / Connexion "L"
023.702		Connessione "T" / Connection "T" / Verbindungsteile "T" / Connexion "T"
023.703		Connessione "+" / Connection "+" / Verbindungsteile "+" / Connexion "+"
023.704		Connessione soffitto-muro / Connection wall-ceiling / Verbindungsteile Wand-Decke / Connexion Plafond-Mur
P001.KIT01		Coppia testate di chiusura / Couple of end caps / 2 Endkappen / 2 tête des profils de terminaux

Ricambio schermo opalino / Opal plastic cover replacement part / Abdeckung in Opalen-Kunststoff Ersatzteil / Diffuseur opal pièce de rechange

029.009.100		1020±10mm
029.009.200		2020±10mm
029.009.300		3020±10mm

Codice Code			
P001B-00	1020±10*	37x1025±10	0,8 Kg
P001C-00	2020±10*	37x2025±10	1,6 Kg
P001D-00	3020±10*	37x3025±10	2,4 Kg

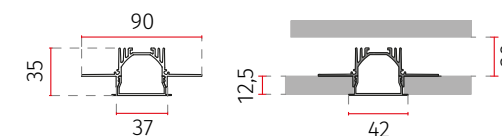

#### P001B - P001C - P001D:

Nella confezione di ogni singolo profilo viene fornito:  
- Profilo in ALUMITE®;  
- Schermo in metacrilato opalino goffrato;  
STRIP LED 9010 DA ORDINARE SEPARATAMENTE.

EN Included in the packaging of each profile:  
- ALUMITE® profile;  
- Screen in opal methacrylate;  
STRIP LED 9010 TO BE ORDERED SEPARATELY.

DE In der Verpackung der einzelnen Profile ist inbegriffen:  
- ALUMITE® Profil;  
- Abdeckung aus Opal-Methacrylat;  
LED STRIP 9010 SEPARAT ZU BESTELLEN.

FR Dans le colisage de chaque profilé est inclus:  
- Profilé en ALUMITE®;  
- couverture opale en methacrylate;  
RUBAN LED 9010 A' COMMANDER SEPAREMENT.

IT I profili vengono forniti con tolleranza +/- 10 mm. Per misure precise si consiglia di ordinare il taglio a misura. L'azienda si riserva la facoltà di apportare variazioni di dati caratteristici, materiali, design, stili, tonalità, senza alcun preavviso.  
EN The profiles are supplied with a tolerance +/- 10 mm. For precise measures, we suggest to order custom cut profiles. The company reserves the right to carry out variations to technical details, materials, design, style, colors with no previous notice.

DE Die Profile werden mit einer Toleranz von +/- 10 mm geliefert. Für genaue Abmessungen empfehlen wir den Zuschnitt zu bestellen. Die Firma behält sich das Recht vor ohne Voranmeldung Änderungen an den Werkstoffen, am Design, am Stil und an der Färbung vorzunehmen.  
FR Les profilés sont fournis avec tolérance de +/- 10 mm. Pour des mesures précises, nous vous suggérons de commander coupe personnalisée. La société se réserve le droit de modifier sans préavis les détails techniques, les matériaux, le design, le style et les couleurs.



**PROFILI**  
Profiles  
Profile  
Profils

ALUMITE® made in Italy

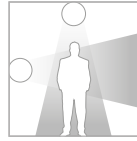

Installabile su legno  
Suitable for Wood

Art. P002 - Private house - Roma, Italy



**P002B - P002C - P002D:**

Nella confezione di ogni singolo profilo viene fornito:

- Profilo in ALUMITE®;
- Doppio schermo di copertura  
A) usa e getta per installazione  
B) metacrilato opalino goffrato;

STRIP LED 9010 DA ORDINARE SEPARATAMENTE

EN Included in the packaging of each profile:

- ALUMITE® profile;
- Dual Cover screen:  
A) Disposable screen for the installation  
B) opal methacrylate screen;

STRIP LED 9010 TO BE ORDERED SEPARATELY.

DE In der Verpackung der einzelnen Profile ist inbegriffen:

- ALUMITE® Profil;
- Dual Abdeckung:  
A) Einweg-Abdeckung für die Installation  
B) Opal-Methacrylat-Abdeckung;

LED STRIP 9010 SEPARAT ZU BESTELLEN.

FR Dans le colisage de chaque profilé est inclus:

- Profilé en ALUMITE®;
- Double couverture:  
A) Diffuseur a usage unique pour l'installation  
B) couverture opale en methacrylate ;

RUBAN LED 9010 A' COMMANDER SEPAREMENT.

**DATI TECNICI / TECHNICAL DATA**

Codice Code			
P002B-00-A	1020±10*	18x1025±10	0,6 Kg
P002C-00-A	2020±10*	18x2025±10	1,2 Kg
P002D-00-A	3020±10*	18x3025±10	1,8 Kg

LED= MAX 30W/m

Profilo fornito con schermo opalino di tipo A e senza parte elettrica

- EN Profile with included opal diffuser Type A and without electrical part
- DE Profil mit Opaler-Abdeckung Typ A ausgestattet und ohne elektrisches Teil
- FR Profilé équipée avec couverture opale Type A et sans partie électrique

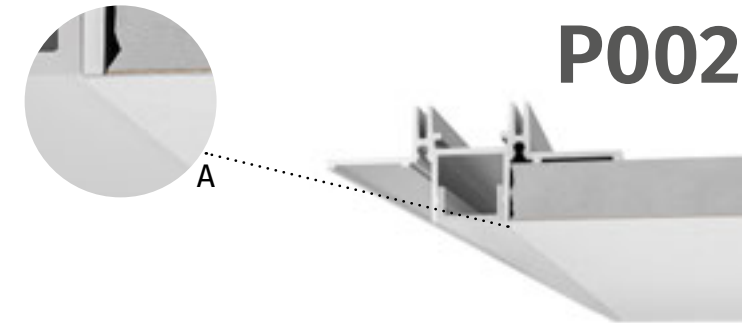

**P002**

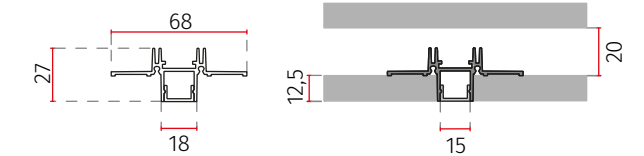

**DATI TECNICI / TECHNICAL DATA**

Codice Code			
P002B-00-B	1020±10*	18x1025±10	0,6 Kg
P002C-00-B	2020±10*	18x2025±10	1,2 Kg
P002D-00-B	3020±10*	18x3025±10	1,8 Kg

LED= MAX 30W/m

Profilo fornito con schermo opalino di tipo B e senza parte elettrica

- EN Profile with included opal diffuser Type B and without electrical part
- DE Profil mit Opaler-Abdeckung Typ B ausgestattet und ohne elektrisches Teil
- FR Profilé équipée avec couverture opale Type B et sans partie électrique

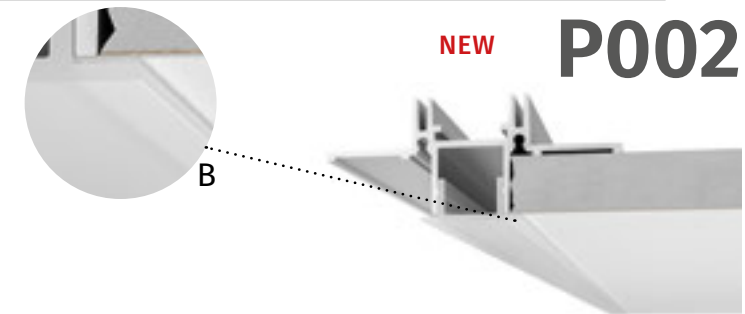

**NEW P002**

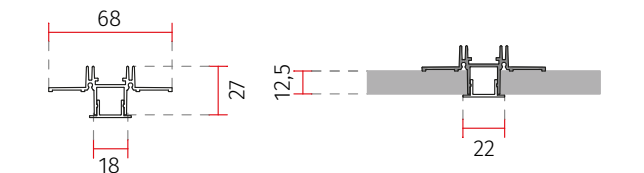

**ACCESSORI / ACCESSORIES**

LED Strip		Pg. 398
TGA		Taglio a misura (45°-90°) / Cut to Size (45°-90°) / Zuschnitt (45°-90°) / Coupé à la taille (45°-90°)
TGP		Taglio a progetto (angoli diversi) / Custom Cut (different angles) / Zuschnitt (andere Winkel) / Coupe personnalisée (autres angles)
023.700		Connessione lineare / Linear connection / Linearen Verbindungsteile / Connexion linéaire
023.701		Connessione "L" / Connection "L" / Verbindungsteile "L" / Connexion "L"
023.702		Connessione "T" / Connection "T" / Verbindungsteile "T" / Connexion "T"
023.703		Connessione "+" / Connection "+" / Verbindungsteile "+" / Connexion "+"
023.704		Connessione soffitto-muro / Connection wall-ceiling / Verbindungsteile Wand-Decke / Connexion Plafond-Mur
P002.KIT01		Coppia testate di chiusura / Couple of end caps / 2 Endkappen / 2 têtes des profils de terminaux

Ricambio schermo opalino tipo A / Opal plastic cover replacement part type A / Abdeckung in Opalen-Kunststoff Ersatzteil Typ A / Diffuseur opal pièce de rechange type A

029.010.100	1020±10mm
029.010.200	2020±10mm
029.010.300	3020±10mm

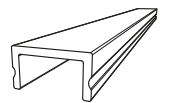

Ricambio schermo opalino tipo B / Opal plastic cover replacement part type B / Abdeckung in Opalen-Kunststoff Ersatzteil Typ B / Diffuseur opal pièce de rechange type B

029.017.100	1020±10mm
029.017.200	2020±10mm
029.017.300	3020±10mm

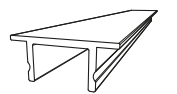

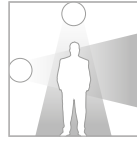

Installabile su legno  
Suitable for Wood

**DATI TECNICI / TECHNICAL DATA**

P003B-00	L 1020±10mm - Senza parte elettrica / Without electrical part / Ohne elektrischen Teil / Sans partie électrique / Without electrical part
P003C-00	L 2020±10mm - Senza parte elettrica / Without electrical part / Ohne elektrischen Teil / Sans partie électrique / Without electrical part
P003D-00	L 3020±10mm - Senza parte elettrica / Without electrical part / Ohne elektrischen Teil / Sans partie électrique / Without electrical part

LED= MAX 40W/m

**ACCESSORI / ACCESSORIES**

LED Strip		Pg. 398
TGA		Taglio a misura (45°-90°) / Cut to Size (45°-90°) / Zuschnitt (45°-90°) / Coupé à la taille (45°-90°)
TGP		Taglio a progetto (angoli diversi) / Custom Cut (different angles) / Zuschnitt (andere Winkel) / Coupe personnalisée (autres angles)
023.700		Connessione lineare / Linear connection / Linearen Verbindungsteile / Connexion linéaire
023.701		Connessione "L" / Connection "L" / Verbindungsteile "L" / Connexion "L"
023.702		Connessione "T" / Connection "T" / Verbindungsteile "T" / Connexion "T"
023.703		Connessione "+" / Connection "+" / Verbindungsteile "+" / Connexion "+"
023.704		Connessione soffitto-muro / Connection wall-ceiling / Verbindungsteile Wand-Decke / Connexion Plafond-Mur
P003.KIT01		Coppia testate di chiusura / Couple of end caps / 2 Endkappen / 2 tête des profils de terminaux

Ricambio schermo opalino / Opal plastic cover replacement part / Abdeckung in Opalen-Kunststoff Ersatzteil / Diffuseur opal pièce de rechange

029.012.100		1020±10mm
029.012.200		2020±10mm
029.012.300		3020±10mm

Codice  
Code

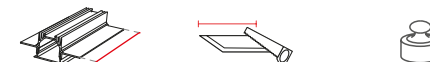

P003B-00	1020±10*	37x1025±10	1,1 Kg
P003C-00	2020±10*	37x2025±10	2,2 Kg
P003D-00	3020±10*	37x3025±10	3,3 Kg

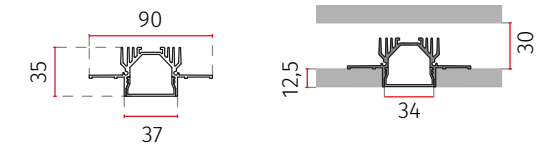

**P003B - P003C - P003D:**

Nella confezione di ogni singolo profilo viene fornito:  
- Profilo in ALUMITE®;  
- Doppio schermo di copertura  
A) usa e getta per installazione  
B) metacrilato opalino goffrato;  
STRIP LED 9010 DA ORDINARE SEPARATAMENTE

EN Included in the packaging of each profile:  
- ALUMITE® profile;  
- Dual Cover screen:  
A) Disposable screen for the installation  
B) opal methacrylate screen;  
STRIP LED 9010 TO BE ORDERED SEPARATELY.

DE In der Verpackung der einzelnen Profile ist inbegriffen:  
- ALUMITE® Profil;  
- Dual Abdeckung:  
A) Einweg-Abdeckung für die Installation  
B) Opal-Methacrylat Abdeckung;  
LED STRIP 9010 SEPARAT ZU BESTELLEN.

FR Dans le paquet de chaque profilé est inclus:  
- Profilé en ALUMITE®;  
- Double couverture:  
A) Diffuseur a usage unique pour l'installation  
B) couverture opale en methacrylate ;  
RUBAN LED 9010 A' COMMANDER SEPAREMENT.

DE Die Profile werden mit einer Toleranz von +/- 10 mm geliefert. Für genaue Abmessungen empfehlen wir den Zuschnitt zu bestellen. Die Firma behält sich das Recht vor ohne Voranmeldung Änderungen an den Werkstoffen, am Design, am Stil und an der Färbung vorzunehmen.  
FR Les profils sont fournis avec tolérance de +/- 10 mm. Pour des mesures précises, nous vous suggérons de commander coupe personnalisée. La société se réserve le droit de modifier sans préavis les détails techniques, les matériaux, le design, le style et les couleurs.

Art. P003 - Restaurant Selice - Imola, Italy



IT I profili vengono forniti con tolleranza +/- 10 mm. Per misure precise si consiglia di ordinare il taglio a misura. L'azienda si riserva la facoltà di apportare variazioni di dati caratteristici, materiali, design, stili, tonalità, senza alcun preavviso.  
EN The profiles are supplied with a tolerance +/- 10 mm. For precise measures, we suggest to order custom cut profiles. The company reserves the right to carry out variations to technical details, materials, design, style, colors with no previous notice.





**PROFILI**  
Profiles  
Profile  
Profilés

ALUMITE®  
made in Italy

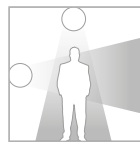

Art. P004 - Private house - Vicenza, Italy  
Arch. Stefano Lucato



**P004**



DATI TECNICI / TECHNICAL DATA	
P004B-00	L 1020±10mm - Senza parte elettrica / Without electrical part / Ohne elektrischen Teil / Sans partie électrique / Without electrical part
P004C-00	L 2020±10mm - Senza parte elettrica / Without electrical part / Ohne elektrischen Teil / Sans partie électrique / Without electrical part
P004D-00	L 3020±10mm - Senza parte elettrica / Without electrical part / Ohne elektrischen Teil / Sans partie électrique / Without electrical part

LED= MAX 60W/m

ACCESSORI / ACCESSORIES	
LED Strip	Pg. 398
TGA	Taglio a misura (45°-90°) / Cut to Size (45°-90°) / Zuschnitt (45°-90°) / Coupé à la taille (45°-90°)
TGP	Taglio a progetto (angoli diversi) / Custom Cut (different angles) / Zuschnitt (andere Winkel) / Coupe personnalisée (autres angles)
023.700	Connessione lineare / Linear connection / Linearen Verbindungsteile / Connexion linéaire
023.701	Connessione "L" / Connection "L" / Verbindungsteile "L" / Connexion "L"
023.702	Connessione "T" / Connection "T" / Verbindungsteile "T" / Connexion "T"
023.703	Connessione "+" / Connection "+" / Verbindungsteile "+" / Connexion "+"
023.704	Connessione soffitto-muro / Connection wall-ceiling / Verbindungsteile Wand-Decke / Connexion Plafond-Mur
P004.KIT01	Coppia testate di chiusura / Couple of end caps / 2 Endkappen / 2 tête des profils de terminaux

Ricambio schermo opalino / Opal plastic cover replacement part / Abdeckung in Opalen-Kunststoff Ersatzteil / Diffuseur opal pièce de rechange

029.011.100		1020±10mm
029.011.200		2020±10mm
029.011.300		3020±10mm

Codice Code			
P004B-00	1020±10*	60x1025±10	1,3 Kg
P004C-00	2020±10*	60x2025±10	2,6 Kg
P004D-00	3020±10*	60x3025±10	3,9 Kg

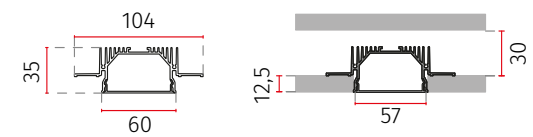

**P004B - P004C - P004D:**

Nella confezione di ogni singolo profilo viene fornito:  
- Profilo in ALUMITE®;  
- Doppio schermo di copertura  
A) usa e getta per installazione  
B) metacrilato opalino goffrato;  
STRIP LED 9010 DA ORDINARE SEPARATAMENTE

EN Included in the packaging of each profile:  
- ALUMITE® profile;  
- Dual Cover screen:  
A) Disposable screen for the installation  
B) opal methacrylate screen;  
STRIP LED 9010 TO BE ORDERED SEPARATELY.

DE In der Verpackung der einzelnen Profile ist inbegriffen:  
- ALUMITE® Profil;  
- Dual Abdeckung:  
A) Einweg-Abdeckung für die Installation  
B) Opal-Methacrylat Abdeckung;  
LED STRIP 9010 SEPARAT ZU BESTELLEN.

FR Dans le paquet de chaque profilé est inclus:  
- Profilé en ALUMITE®;  
- Double couverture:  
A) Diffuseur a usage unique pour l'installation  
B) couverture opale en methacrylate ;  
RUBAN LED 9010 A' COMMANDER SEPAREMENT.

IT I profili vengono forniti con tolleranza +/- 10 mm. Per misure precise si consiglia di ordinare il taglio a misura. L'azienda si riserva la facoltà di apportare variazioni di dati caratteristici, materiali, design, stili, tonalità, senza alcun preavviso.  
EN The profiles are supplied with a tolerance +/- 10 mm. For precise measures, we suggest to order custom cut profiles. The company reserves the right to carry out variations to technical details, materials, design, style, colors with no previous notice.

DE Die Profile werden mit einer Toleranz von +/- 10 mm geliefert. Für genaue Abmessungen empfehlen wir den Zuschnitt zu bestellen. Die Firma behält sich das Recht vor ohne Voranmeldung Änderungen an den Werkstoffen, am Design, am Stil und an der Färbung vorzunehmen.  
FR Les profilés sont fournis avec tolérance de +/- 10 mm. Pour des mesures précises, nous vous suggérons de commander coupe personnalisée. La société se réserve le droit de modifier sans préavis les détails techniques, les matériaux, le design, le style et les couleurs.

**PROFILI**  
Profiles  
Profile  
Profilés

ALUMITE®

made in Italy

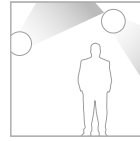

Installabile su legno  
Suitable for Wood

Art. P005 / 4248E - Private house - Vicenza, Italy  
Arch. Stefano Lucato



**DATI TECNICI / TECHNICAL DATA**

P005B-00	L 1020±10mm - Senza parte elettrica / Without electrical part / Ohne elektrischen Teil / Sans partie électrique / Without electrical part
P005C-00	L 2020±10mm - Senza parte elettrica / Without electrical part / Ohne elektrischen Teil / Sans partie électrique / Without electrical part
P005D-00	L 3020±10mm - Senza parte elettrica / Without electrical part / Ohne elektrischen Teil / Sans partie électrique / Without electrical part

LED= MAX 30W/m

**ACCESSORI / ACCESSORIES**

LED Strip		Pg. 398
TGA		Taglio a misura (45°-90°) / Cut to Size (45°-90°) / Zuschnitt (45°-90°) / Coupé à la taille (45°-90°)
TGP		Taglio a progetto (angoli diversi) / Custom Cut (different angles) / Zuschnitt (andere Winkel) / Coupe personnalisée (autres angles)
023.700		Connessione lineare / Linear connection / Linearen Verbindungsteile / Connexion linéaire
023.701		Connessione "L" / Connection "L" / Verbindungsteile "L" / Connexion "L"
023.704		Connessione soffitto-muro / Connection wall-ceiling / Verbindungsteile Wand-Decke / Connexion Plafond-Mur
P005.KIT01		Coppia testate di chiusura / Couple of end caps / 2 Endkappen / 2 tête des profils de terminaux

Ricambio schermo opalino / Opal plastic cover replacement part / Abdeckung in Opalen-Kunststoff Ersatzteil / Diffuseur opal pièce de rechange

029.010.100		1020±10mm
029.010.200		2020±10mm
029.010.300		3020±10mm

Codice Code			
P005B-00	1020±10*	53x1025±10	1,2 Kg
P005C-00	2020±10*	53x2025±10	2,4 Kg
P005D-00	3020±10*	53x3025±10	3,6 Kg

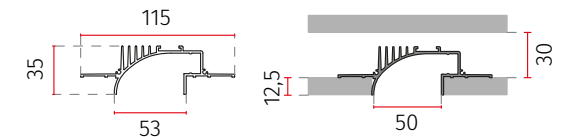

**P005B - P005C - P005D:**

Nella confezione di ogni singolo profilo viene fornito:  
- Profilo in ALUMITE® verniciato ral 9010 opaco;  
- Schermo in metacrilato opalino goffrato;  
STRIP LED 9010 DA ORDINARE SEPARATAMENTE

EN Included in the packaging of each profile:  
- ALUMITE® profile painted ral 9010 matt;  
- Screen in opal methacrylate;  
STRIP LED 9010 TO BE ORDERED SEPARATELY.

DE In der Verpackung der einzelnen Profile ist inbegriffen:  
- ALUMITE® Profil Lackiert Ral 9010 Matt;  
- Abdeckung in Opal-Methacrylat;  
LED STRIP 9010 SEPARAT ZU BESTELLEN.

FR Dans le paquet de chaque profilé est inclus:  
- Profilé en ALUMITE® peint RAL 9010 opaque;  
- Couverture opale en methacrylate;  
RUBAN LED 9010 A' COMMANDER SEPAREMENT.

IT I profili vengono forniti con tolleranza +/- 10 mm. Per misure precise si consiglia di ordinare il taglio a misura. L'azienda si riserva la facoltà di apportare variazioni di dati caratteristici, materiali, design, stili, tonalità, senza alcun preavviso.  
EN The profiles are supplied with a tolerance +/- 10 mm. For precise measures, we suggest to order custom cut profiles. The company reserves the right to carry out variations to technical details, materials, design, style, colors with no previous notice.

DE Die Profile werden mit einer Toleranz von +/- 10 mm geliefert. Für genaue Abmessungen empfehlen wir den Zuschnitt zu bestellen. Die Firma behält sich das Recht vor ohne Voranmeldung Änderungen an den Werkstoffen, am Design, am Stil und an der Färbung vorzunehmen.  
FR Les profilés sont fournis avec tolérance de +/- 10 mm. Pour des mesures précises, nous vous suggérons de commander coupe personnalisée. La société se réserve le droit de modifier sans préavis les détails techniques, les matériaux, le design, le style et les couleurs.

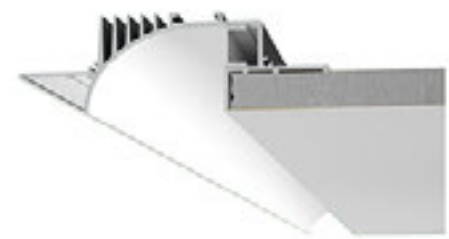

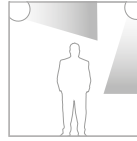

Installabile su legno  
Suitable for Wood

Art. P007 - Colonia Fara - Chiavari, Italy  
Arch. Paola Cella - Ph. Roberto Gregori



**TIPOLOGIE DI INSTALLAZIONE / TYPES OF INSTALLATION /  
TYPES OF INSTALLATION / TYPE D'INSTALLATION**

Il profilo P007 può essere installato utilizzando almeno due staffe di fissaggio 023.844 ogni metro, ordinabili separatamente, oppure incollando direttamente la parte curva del profilo al muro.

EN The P007 profile can be installed with at least two fixing bracket 023.844 for each meter of profile, that can be ordered separately, or gluing directly the curved fixing part onto the wall.

DE Das P007-Profil kann mit mindestens zwei Befestigungswinkel 023.844 für ein Meter-Profil installiert werden, die separat bestellbar sind, oder das gebogene Befestigungsteil kann direkt an die Wand geklebt werden.

FR Le profilé P007 peut être installé avec au moins deux pattes de fixation 023.844 pour chaque mètre de profilé, que peut être commandé séparément ou avec de la colle sur la partie de fixation incurvée et le mur.

INSTALLAZIONE CON LA COLLA / INSTALLATION WITH GLUE /  
INSTALLATION MIT KLEBSTOFF / INSTALLATION AVEC DE LA COLLE

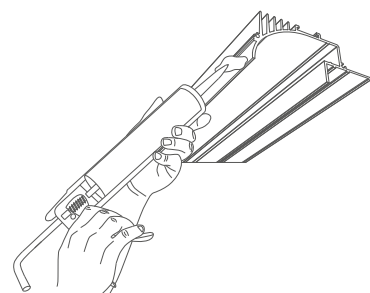

INSTALLAZIONE TRAMITE STAFFA DI FISSAGGIO / INSTALLATION WITH  
FIXING BRACKET / MONTAGE MIT BEFESTIGUNGSWINKEL / INSTALLATION  
AVEC PATTE DE FIXATION

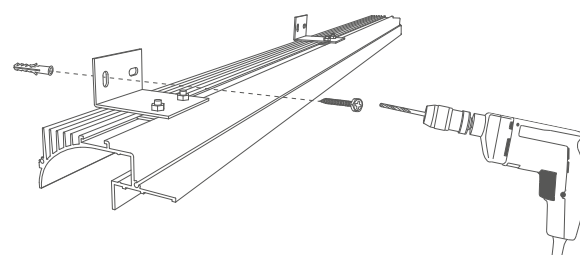

IT I profili vengono forniti con tolleranza +/- 10 mm. Per misure precise si consiglia di ordinare il taglio a misura. L'azienda si riserva la facoltà di apportare variazioni di dati caratteristici, materiali, design, stili, tonalità, senza alcun preavviso.  
EN The profiles are supplied with a tolerance +/- 10 mm. For precise measures, we suggest to order custom cut profiles. The company reserves the right to carry out variations to technical details, materials, design, style, colors with no previous notice.

**DATI TECNICI / TECHNICAL DATA**

P007B-00	L 1020±10mm - Senza parte elettrica / Without electrical part / Ohne elektrischen Teil / Sans partie électrique
P007C-00	L 2020±10mm - Senza parte elettrica / Without electrical part / Ohne elektrischen Teil / Sans partie électrique
P007D-00	L 3020±10mm - Senza parte elettrica / Without electrical part / Ohne elektrischen Teil / Sans partie électrique

LED= MAX 30W/m

**ACCESSORI / ACCESSORIES**

LED Strip	Pg. 398
TGA	Taglio a misura (45°-90°) / Cut to Size (45°-90°) / Zuschnitt (45°-90°) / Coupé à la taille (45°-90°)
TGP	Taglio a progetto (angoli diversi) / Custom Cut (different angles) / Zuschnitt (andere Winkel) / Coupe personnalisée (autres angles)
023.700	Connessione lineare / Linear connection / Linearen Verbindungsteile / Connexion linéaire
023.701	Connessione "L" / Connection "L" / Verbindungsteile "L" / Connexion "L"
023.704	Connessione soffitto-muro / Connection wall-ceiling / Verbindungsteile Wand-Decke / Connexion Plafond-Mur
023.844 (2pz x 1mt)	Staffa di fissaggio al muro / Wall fixing bracket / Wand Halterung / Support Muraux
P005.KIT01	Coppia testate di chiusura / Couple of end caps / 2 Endkappen / 2 tête des profils de terminaux

Ricambio schermo opalino / Opal plastic cover replacement part /  
Abdeckung in Opalen-Kunststoff Ersatzteil / Diffuseur opal pièce de rechange

029.010.100	1020±10mm
029.010.200	2020±10mm
029.010.300	3020±10mm

Codice  
Code

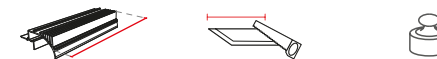

P007B-00	1020±10*	53x1025±10	1,1 Kg
P007C-00	2020±10*	53x2025±10	2,2 Kg
P007D-00	3020±10*	53x3025±10	3,3 Kg

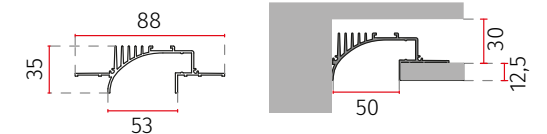

**P007B - P007C - P007D:**

Nella confezione di ogni singolo profilo viene fornito:  
- Profilo in ALUMITE® verniciato ral 9010 opaco;  
- Schermo in metacrilato opalino goffrato;  
STRIP LED 9010 DA ORDINARE SEPARATAMENTE

EN Included in the packaging of each profile:  
- ALUMITE® profile painted ral 9010 matt;  
- Screen in opal methacrylate;  
STRIP LED 9010 TO BE ORDERED SEPARATELY.

DE In der Verpackung der einzelnen Profile ist inbegriffen:  
- ALUMITE® Profil Lackiert Ral 9010 Matt;  
- Abdeckung in Opal-Methacrylat;  
LED STRIP 9010 SEPARAT ZU BESTELLEN.

FR Dans le paquet de chaque profilé est inclus:  
- Profilé en ALUMITE® peint RAL 9010 opaque;  
- Couverture opale en methacrylate;  
RUBAN LED 9010 A' COMMANDER SEPAREMENT.

DE Die Profile werden mit einer Toleranz von +/- 10 mm geliefert. Für genaue Abmessungen empfehlen wir den Zuschnitt zu bestellen. Die Firma behält sich das Recht vor ohne Voranmeldung Änderungen an den Werkstoffen, am Design, am Stil und an der Färbung vorzunehmen.  
FR Les profilés sont fournis avec tolérance de +/- 10 mm. Pour des mesures précises, nous vous suggérons de commander coupe personnalisée. La société se réserve le droit de modifier sans préavis les détails techniques, les matériaux, le design, le style et les couleurs.

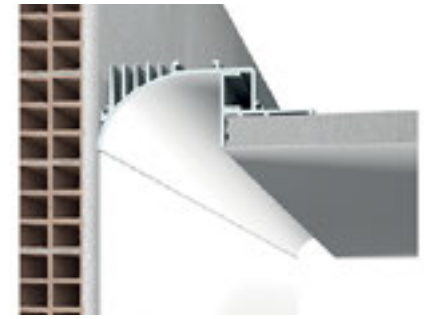



# PER OGNI ESIGENZA

**DESIGN ESSENZIALE**  
ESSENTIAL DESIGN

**FACILE DA INSTALLARE**  
EASY INSTALLATION

**LUCE DIFFUSA**  
DIFFUSED LIGHT

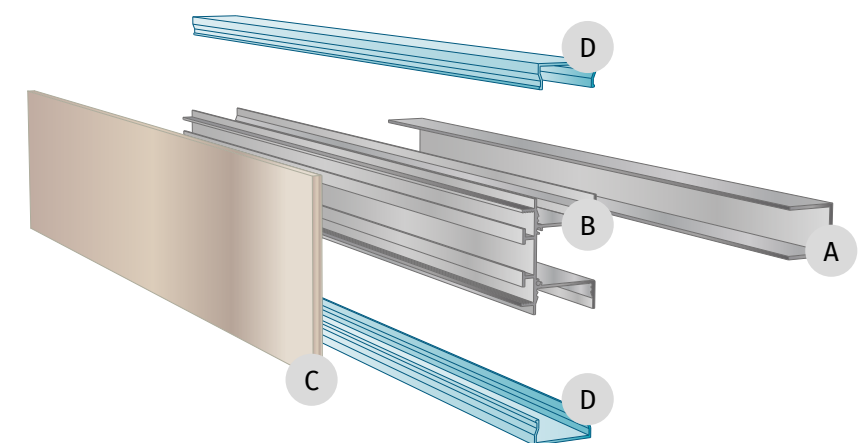

- A**

**Staffa in ALUMITE®**  
ALUMITE® bracket  
ALUMITE®-Halterung  
Support en ALUMITE®
- B**

**Profilo in ALUMITE®**  
ALUMITE® profile  
ALUMITE® Profil  
Profilé ALUMITE®
- C**

**Frontale personalizzabile**  
Customizable front part  
Anpassbares Vorderteil  
Partie avant personnalisable
- D**

**Schermo opalino**  
Opal diffuser  
Opale-Abdeckung  
Diffuseur opale

9010 presenta la lampada da parete che puoi personalizzare secondo le tue esigenze per non porre limiti alla creatività, permettendoti di applicare a questo prodotto materiali, texture e colori diversi.

ENG 9010 introduces a wall lamps collection that can be tailored according to any need. 9010 does not pose limits to creativity, allowing you to apply different materials, textures and colors, according to the designer's needs.  
DE 9010 führt eine Wandlampenkollektion ein, die an jeden Bedarf angepasst werden kann. 9010 setzt der Kreativität keine Grenzen. Sie können je nach den Bedürfnissen des Designers unterschiedliche Materialien, Strukturen und Farben anwenden.  
FR 9010 présente une collection d'appliques adaptable à tous les besoins. 9010 ne pose pas de limites à la créativité, vous permettant d'appliquer différents matériaux, textures et couleurs en fonction des besoins du concepteur.



# PROFILI

## Profiles

### Profile

### Profilés

ALUMITE®

made in Italy

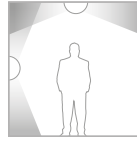

# P009



Art. P009 / 2426 - Private house - Bologna, Italy



#### DATI TECNICI / TECHNICAL DATA

P009B-00	L 1020±10mm - Senza parte elettrica / Without electrical part / Ohne elektrischen Teil / Sans partie électrique
P009C-00	L 2020±10mm - Senza parte elettrica / Without electrical part / Ohne elektrischen Teil / Sans partie électrique
P009D-00	L 3020±10mm - Senza parte elettrica / Without electrical part / Ohne elektrischen Teil / Sans partie électrique

LED= MAX 2x26W/m

#### ACCESSORI / ACCESSORIES

LED Strip	Pg. 398
TGA	Taglio a misura (45°-90°) / Cut to Size (45°-90°) / Zuschnitt (45°-90°) / Coupé à la taille (45°-90°)
TGP	Taglio a progetto (angoli diversi) / Custom Cut (different angles) / Zuschnitt (andere Winkel) / Coupe personnalisée (autres angles)
P009.KIT01	Coppia testate di chiusura / Couple of end caps / 2 Endkappen / 2 tête des profils de terminaux
P009B.KIT02	L1000 profilo ad "U" per fissaggio al soffitto / U shaped profile for ceiling fixing / U-Profil für Deckenmontage / Profile à U fixation au plafond
P009B.KIT03	L1000 profilo ad "L" per fissaggio a parete / L shaped profile for wall fixing / L-Profil für Wandmontage / Profile à L fixation mural
P009C.KIT02	L2000 profilo ad "U" per fissaggio al soffitto / U shaped profile for ceiling fixing / U-Profil für Deckenmontage / Profile à U fixation au plafond
P009C.KIT03	L2000 profilo ad "L" per fissaggio a parete / L shaped profile for wall fixing / L-Profil für Wandmontage / Profile à L fixation mural
P009D.KIT02	L3000 profilo ad "U" per fissaggio al soffitto / U shaped profile for ceiling fixing / U-Profil für Deckenmontage / Profile à U fixation au plafond
P009D.KIT03	L3000 profilo ad "L" per fissaggio a parete / L shaped profile for wall fixing / L-Profil für Wandmontage / Profile à L fixation mural

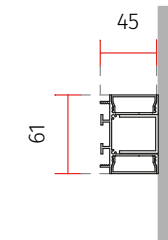

Codice Code

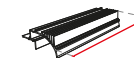

P009B-00	1020±10*	1,1 Kg
P009C-00	2020±10*	2 Kg
P009D-00	3020±10*	2,9 Kg

Ricambio schermo opalino / Opal plastic cover replacement part / Abdeckung in Opalen-Kunststoff Ersatzteil / Diffuseur opal pièce de rechange

029.012.100	1020±10mm
029.012.200	2020±10mm
029.012.300	3020±10mm

#### DRIVER ON/OFF SLIM

026.267	max60W 24Vdc
026.268	max100W 24Vdc
026.269	max150W 24Vdc

P009B.KIT02 - P009C.KIT02 - P009D.KIT02  
INSTALLAZIONE A SOFFITTO E A PARETE / CEILING AND WALL INSTALLATION / DECKEN- UND WANDMONTAGE / INSTALLATION AU PLAFOND ET AU MUR

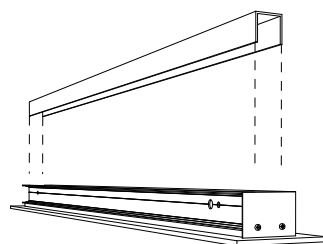

P009B.KIT03 - P009C.KIT03 - P009D.KIT03  
INSTALLAZIONE A PARETE / WALL INSTALLATION / WANDMONTAGE / INSTALLATION AU MUR

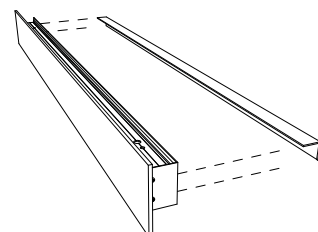

#### P009B - P009C - P009D:

Nella confezione di ogni singolo profilo viene fornito:  
- Profilo in ALUMITE® anodizzato grigio;  
- Doppio schermo in metacrilato opalino goffrato;  
STRIP LED 9010 DA ORDINARE SEPARATAMENTE

DE In der Verpackung der einzelnen Profile ist inbegriffen:  
- ALUMITE® Profil grau eloxiert;  
- Dual Abdeckung in Opal-Methacrylat;  
LED STRIP 9010 SEPARAT ZU BESTELLEN.

EN Included in the packaging of each profile:  
- ALUMITE® grey anodized profile;  
- Dual cover screen in opal methacrylate;  
STRIP LED 9010 TO BE ORDERED SEPARATELY.

FR Dans le colisage de chaque profilé est inclus:  
- Profilé en ALUMITE® gris anodisé;  
- Couverture opale en methacrylate;  
RUBAN LED 9010 A COMMANDER SEPAREMENT.

IT I profili vengono forniti con tolleranza +/- 10 mm. Per misure precise si consiglia di ordinare il taglio a misura. L'azienda si riserva la facoltà di apportare variazioni di dati caratteristici, materiali, design, stili, tonalità, senza alcun preavviso.  
EN The profiles are supplied with a tolerance +/- 10 mm. For precise measures, we suggest to order custom cut profiles. The company reserves the right to carry out variations to technical details, materials, design, style, colors with no previous notice.

DE Die Profile werden mit einer Toleranz von +/- 10 mm geliefert. Für genaue Abmessungen empfehlen wir den Zuschnitt zu bestellen. Die Firma behält sich das Recht vor ohne Voranmeldung Änderungen an den Werkstoffen, am Design, am Stil und an der Färbung vorzunehmen.  
FR Les profilés sont fournis avec tolérance de +/- 10 mm. Pour des mesures précises, nous vous suggérons de commander coupe personnalisée. La société se réserve le droit de modifier sans préavis les détails techniques, les matériaux, le design, le style et les couleurs.

# PROFILI

Profiles  
Profile  
Profils

ALUMITE® made in Italy

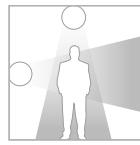

**Versione B:** Sistema di incasso rapido (senza stuccatura) / Quick recessing system (Plaster finish is not required) / Schnelles Einbausystem (Ohne Verputz) / Système d'encastrement rapide (Enduit non requis)

Art. P010



## P010B - P010C - P010D:

Nella confezione di ogni singolo profilo viene fornito:  
- Profilo in ALUMITE® anodizzato grigio;  
- Schermo in metacrilato opalino goffrato;  
STRIP LED 9010 DA ORDINARE SEPARATAMENTE.

EN Included in the packaging of each profile:  
- ALUMITE® grey anodized profile;  
- Screen in opal methacrylate;  
STRIP LED 9010 TO BE ORDERED SEPARATELY.

DE In der Verpackung der einzelnen Profile ist inbegriffen:  
- ALUMITE® Profil grau eloxiert;  
- Abdeckung aus Opal-Methacrylat;  
LED STRIP 9010 SEPARAT ZU BESTELLEN.

FR Dans le colisage de chaque profilé est inclus:  
- Profilé en ALUMITE® gris anodisé;  
- couverture opale en methacrylate;  
RUBAN LED 9010 A' COMMANDER SEPAREMENT.

IT I profili vengono forniti con tolleranza +/- 10 mm. Per misure precise si consiglia di ordinare il taglio a misura. L'azienda si riserva la facoltà di apportare variazioni di dati caratteristici, materiali, design, stili, tonalità, senza alcun preavviso.  
EN The profiles are supplied with a tolerance +/- 10 mm. For precise measures, we suggest to order custom cut profiles. The company reserves the right to carry out variations to technical details, materials, design, style, colors with no previous notice.

### DATI TECNICI / TECHNICAL DATA

Codice Code			
P010B-00-A	1020±10*	18x1025±10	0,22 Kg
P010C-00-A	2020±10*	18x2025±10	0,44 Kg
P010D-00-A	3020±10*	18x3025±10	0,66 Kg

LED= MAX 10W/m

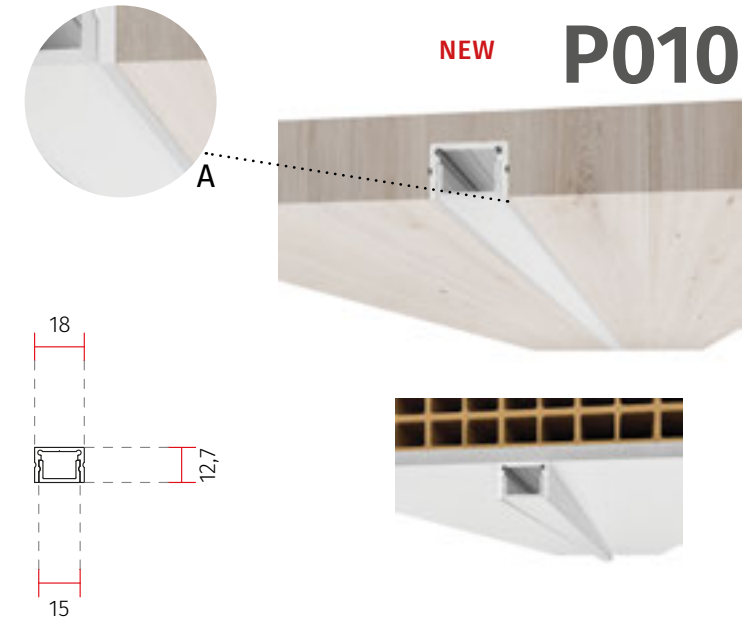

Profilo fornito con schermo opalino di tipo A e senza parte elettrica

EN Profile with included opal diffuser Type A and without electrical part  
DE Profil mit Opaler-Abdeckung Typ A ausgestattet und ohne elektrisches Teil  
FR Profilé équipée avec couverture opale Type A et sans partie électrique

### DATI TECNICI / TECHNICAL DATA

Codice Code			
P010B-00-B	1020±10*	18x1025±10	0,22 Kg
P010C-00-B	2020±10*	18x2025±10	0,44 Kg
P010D-00-B	3020±10*	18x3025±10	0,66 Kg

LED= MAX 10W/m

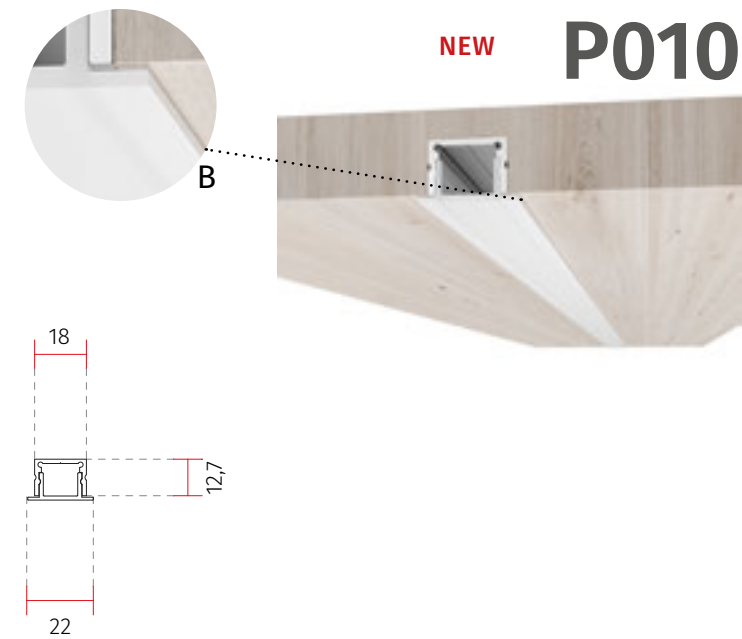

Profilo fornito con schermo opalino di tipo B e senza parte elettrica

EN Profile with included opal diffuser Type B and without electrical part  
DE Profil mit Opaler-Abdeckung Typ B ausgestattet und ohne elektrisches Teil  
FR Profilé équipée avec couverture opale Type B et sans partie électrique

### ACCESSORI / ACCESSORIES

LED Strip		Pg. 398	Ricambio schermo opalino tipo A / Opal plastic cover replacement part type A / Abdeckung in Opalen-Kunststoff Ersatzteil Typ A / Diffuseur opal pièce de rechange type A
TGA		Taglio a misura (45°-90°) / Cut to Size (45°-90°) / Zuschnitt (45°-90°) / Coupé à la taille (45°-90°)	029.010.100 1020±10mm
TGP		Taglio a progetto (angoli diversi) / Custom Cut (different angles) / Zuschnitt (andere Winkel) / Coupe personnalisée (autres angles)	029.010.200  2020±10mm
P012.KIT01		Coppia testate di chiusura / Couple of end caps / 2 Endkappen / 2 tête des profils de terminaux	029.010.300  3020±10mm
			Ricambio schermo opalino tipo B / Opal plastic cover replacement part type B / Abdeckung in Opalen-Kunststoff Ersatzteil Typ B / Diffuseur opal pièce de rechange type B
			029.017.100  1020±10mm
			029.017.200  2020±10mm
			029.017.300  3020±10mm

DE Die Profile werden mit einer Toleranz von +/- 10 mm geliefert. Für genaue Abmessungen empfehlen wir den Zuschnitt zu bestellen. Die Firma behält sich das Recht vor ohne Voranmeldung Änderungen an den Werkstoffen, am Design, am Stil und an der Färbung vorzunehmen.  
FR Les profilés sont fournis avec tolérance de +/- 10 mm. Pour des mesures précises, nous vous suggérons de commander coupe personnalisée. La société se réserve le droit de modifier sans préavis les détails techniques, les matériaux, le design, le style et les couleurs.

# PROFILI

Profiles  
Profile  
Profils

ALUMITE® made in Italy

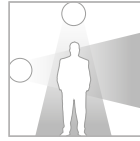

**Versione B:** Sistema di incasso rapido (senza stuccatura) / Quick recessing system (Plaster finish is not required) / Schnelles Einbausystem (Ohne Verputz) / Système d'encastrement rapide (Enduit non requis)

Art. P011



Art. P011



## P011B - P011C - P011D:

Nella confezione di ogni singolo profilo viene fornito:  
- Profilo in ALUMITE® anodizzato grigio;  
- Schermo in metacrilato opalino goffrato;  
STRIP LED 9010 DA ORDINARE SEPARATAMENTE.

EN Included in the packaging of each profile:  
- ALUMITE® grey anodized profile;  
- Screen in opal methacrylate;  
STRIP LED 9010 TO BE ORDERED SEPARATELY.

DE In der Verpackung der einzelnen Profile ist inbegriffen:  
- ALUMITE® Profil grau eloxiert;  
- Abdeckung aus Opal-Methacrylat;  
LED STRIP 9010 SEPARAT ZU BESTELLEN.

FR Dans le colisage de chaque profilé est inclus:  
- Profilé en ALUMITE® gris anodisé;  
- couverture opale en methacrylate;  
RUBAN LED 9010 A' COMMANDER SEPAREMENT.

IT I profili vengono forniti con tolleranza +/- 10 mm. Per misure precise si consiglia di ordinare il taglio a misura. L'azienda si riserva la facoltà di apportare variazioni di dati caratteristici, materiali, design, stili, tonalità, senza alcun preavviso.  
EN The profiles are supplied with a tolerance +/- 10 mm. For precise measures, we suggest to order custom cut profiles. The company reserves the right to carry out variations to technical details, materials, design, style, colors with no previous notice.

### DATI TECNICI / TECHNICAL DATA

Codice Code			
P011B-00-A	1020±10*	33x1025±10	0,31 Kg
P011C-00-A	2020±10*	33x2025±10	0,61 Kg
P011D-00-A	3020±10*	33x3025±10	0,92 Kg

LED= MAX 18W/m

Profilo fornito con schermo opalino di tipo A e senza parte elettrica

EN Profile with included opal diffuser Type A and without electrical part  
DE Profil mit Opaler-Abdeckung Typ A ausgestattet und ohne elektrisches Teil  
FR Profilé équipée avec couverture opale Type A et sans partie électrique

### DATI TECNICI / TECHNICAL DATA

Codice Code			
P011B-00-B	1020±10*	33x1025±10	0,31 Kg
P011C-00-B	2020±10*	33x2025±10	0,61 Kg
P011D-00-B	3020±10*	33x3025±10	0,92 Kg

LED= MAX 18W/m

Profilo fornito con schermo opalino di tipo B e senza parte elettrica

EN Profile with included opal diffuser Type B and without electrical part  
DE Profil mit Opaler-Abdeckung Typ B ausgestattet und ohne elektrisches Teil  
FR Profilé équipée avec couverture opale Type B et sans partie électrique

### ACCESSORI / ACCESSORIES

LED Strip		Pg. 398
TGA		Taglio a misura (45°-90°) / Cut to Size (45°-90°) / Zuschnitt (45°-90°) / Coupé à la taille (45°-90°)
TGP		Taglio a progetto (angoli diversi) / Custom Cut (different angles) / Zuschnitt (andere Winkel) / Coupe personnalisée (autres angles)
P013.KIT01		Coppia testate di chiusura / Couple of end caps / 2 Endkappen / 2 tête des profils de terminaux

Ricambio schermo opalino tipo A / Opal plastic cover replacement part type A / Abdeckung in Opalen-Kunststoff Ersatzteil Typ A / Diffuseur opal pièce de rechange type A

029.018.100		1020±10mm
029.018.200		2020±10mm
029.018.300		3020±10mm

Ricambio schermo opalino tipo B / Opal plastic cover replacement part type B / Abdeckung in Opalen-Kunststoff Ersatzteil Typ B / Diffuseur opal pièce de rechange type B

029.019.100		1020±10mm
029.019.200		2020±10mm
029.019.300		3020±10mm

DE Die Profile werden mit einer Toleranz von +/- 10 mm geliefert. Für genaue Abmessungen empfehlen wir den Zuschnitt zu bestellen. Die Firma behält sich das Recht vor ohne Voranmeldung Änderungen an den Werkstoffen, am Design, am Stil und an der Färbung vorzunehmen.  
FR Les profilés sont fournis avec tolérance de +/- 10 mm. Pour des mesures précises, nous vous suggérons de commander coupe personnalisée. La société se réserve le droit de modifier sans préavis les détails techniques, les matériaux, le design, le style et les couleurs.

# PROFILI

Profiles  
Profile  
Profils

ALUMITE® made in Italy

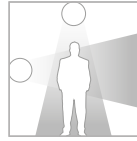

**Versione B: Sistema di incasso rapido (senza stuccatura) / Quick recessing system (Plaster finish is not required) / Schnelles Einbausystem (Ohne Verputz) / Système d'encastrement rapide (Enduit non requis)**

Art. P012



## P012B - P012C - P012D:

Nella confezione di ogni singolo profilo viene fornito:

- Profilo in ALUMITE®;
- Doppio schermo di copertura  
A) usa e getta per installazione  
B) metacrilato opalino goffrato;

STRIP LED 9010 DA ORDINARE SEPARATAMENTE

EN Included in the packaging of each profile:

- ALUMITE® profile;
- Dual Cover screen:  
A) Disposable screen for the installation  
B) opal methacrylate screen;

STRIP LED 9010 TO BE ORDERED SEPARATELY.

DE In der Verpackung der einzelnen Profile ist inbegriffen:

- ALUMITE® Profil;
- Dual Abdeckung:  
A) Einweg-Abdeckung für die Installation  
B) Opal-Methacrylat-Abdeckung;

LED STRIP 9010 SEPARAT ZU BESTELLEN.

FR Dans le paquet de chaque profilé est inclus:

- Profilé en ALUMITE®;
- Double couverture:  
A) Diffuseur a usage unique pour l'installation  
B) couverture opale en methacrylate ;

RUBAN LED 9010 A' COMMANDER SEPAREMENT.

IT I profili vengono forniti con tolleranza +/- 10 mm. Per misure precise si consiglia di ordinare il taglio a misura. L'azienda si riserva la facoltà di apportare variazioni di dati caratteristici, materiali, design, stili, tonalità, senza alcun preavviso.  
EN The profiles are supplied with a tolerance +/- 10 mm. For precise measures, we suggest to order custom cut profiles. The company reserves the right to carry out variations to technical details, materials, design, style, colors with no previous notice.

### DATI TECNICI / TECHNICAL DATA

Codice Code			
P012B-00-A	1020±10*	18x1025±10	0,37 Kg
P012C-00-A	2020±10*	18x2025±10	0,74 Kg
P012D-00-A	3020±10*	18x3025±10	1,11 Kg

LED= MAX 18W/m

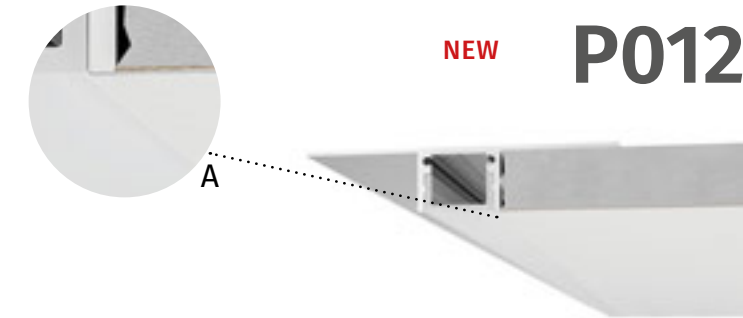

NEW P012

Profilo fornito con schermo opalino di tipo A e senza parte elettrica

EN Profile with included opal diffuser Type A and without electrical part

DE Profil mit Opaler-Abdeckung Typ A ausgestattet und ohne elektrisches Teil

FR Profilé équipée avec couverture opale Type A et sans partie électrique

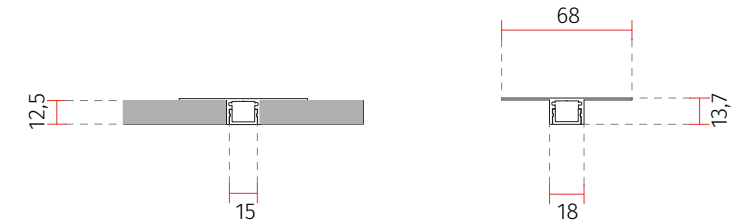

### DATI TECNICI / TECHNICAL DATA

Codice Code			
P012B-00-B	1020±10*	18x1025±10	0,37 Kg
P012C-00-B	2020±10*	18x2025±10	0,74 Kg
P012D-00-B	3020±10*	18x3025±10	1,11 Kg

LED= MAX 18W/m

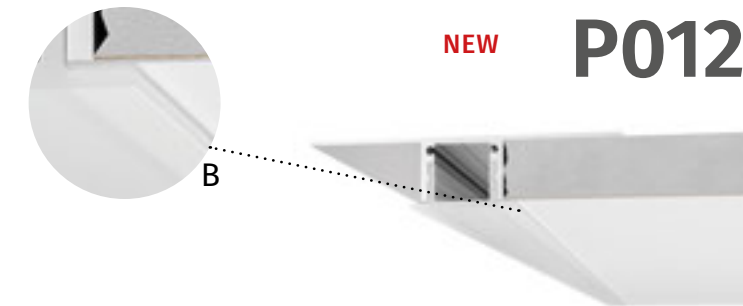

NEW P012

Profilo fornito con schermo opalino di tipo B e senza parte elettrica

EN Profile with included opal diffuser Type B and without electrical part

DE Profil mit Opaler-Abdeckung Typ B ausgestattet und ohne elektrisches Teil

FR Profilé équipée avec couverture opale Type B et sans partie électrique

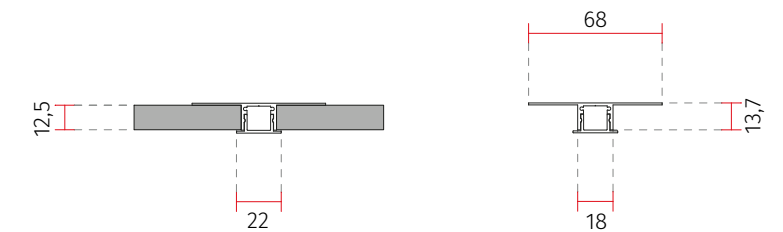

### ACCESSORI / ACCESSORIES

LED Strip		Pg. 398
TGA		Taglio a misura (45°-90°) / Cut to Size (45°-90°) / Zuschnitt (45°-90°) / Coupé à la taille (45°-90°)
TGP		Taglio a progetto (angoli diversi) / Custom Cut (different angles) / Zuschnitt (andere Winkel) / Coupe personnalisée (autres angles)
P012.KIT01		Coppia testate di chiusura / Couple of end caps / 2 Endkappen / 2 tête des profils de terminaux

Ricambio schermo opalino tipo A / Opal plastic cover replacement part type A / Abdeckung in Opalen-Kunststoff Ersatzteil Typ A / Diffuseur opal pièce de rechange type A

029.010.100 1020±10mm

029.010.200 2020±10mm

029.010.300 3020±10mm

Ricambio schermo opalino tipo B / Opal plastic cover replacement part type B / Abdeckung in Opalen-Kunststoff Ersatzteil Typ B / Diffuseur opal pièce de rechange type B

029.017.100 1020±10mm

029.017.200 2020±10mm

029.017.300 3020±10mm

DE Die Profile werden mit einer Toleranz von +/- 10 mm geliefert. Für genaue Abmessungen empfehlen wir den Zuschnitt zu bestellen. Die Firma behält sich das Recht vor ohne Voranmeldung Änderungen an den Werkstoffen, am Design, am Stil und an der Färbung vorzunehmen.  
FR Les profilés sont fournis avec tolérance de +/- 10 mm. Pour des mesures précises, nous vous suggérons de commander coupe personnalisée. La société se réserve le droit de modifier sans préavis les détails techniques, les matériaux, le design, le style et les couleurs.



# PROFILI

Profiles  
Profile  
Profils

ALUMITE® made in Italy

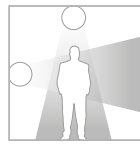

**Versione B: Sistema di incasso rapido (senza stuccatura) / Quick recessing system (Plaster finish is not required) / Schnelles Einbausystem (Ohne Verputz) / Système d'encastrement rapide (Enduit non requis)**

Art. P013



## P013B - P013C - P013D:

Nella confezione di ogni singolo profilo viene fornito:

- Profilo in ALUMITE®;
- Doppio schermo di copertura  
A) usa e getta per installazione  
B) metacrilato opalino goffrato;

STRIP LED 9010 DA ORDINARE SEPARATAMENTE

EN Included in the packaging of each profile:

- ALUMITE® profile;
- Dual Cover screen:  
A) Disposable screen for the installation  
B) opal methacrylate screen;

STRIP LED 9010 TO BE ORDERED SEPARATELY.

DE In der Verpackung der einzelnen Profile ist inbegriffen:

- ALUMITE® Profil;
- Dual Abdeckung:  
A) Einweg-Abdeckung für die Installation  
B) Opal-Methacrylat-Abdeckung;

LED STRIP 9010 SEPARAT ZU BESTELLEN.

FR Dans le paquet de chaque profilé est inclus:

- Profilé en ALUMITE®;
- Double couverture:  
A) Diffuseur a usage unique pour l'installation  
B) couverture opale en methacrylate ;

RUBAN LED 9010 A' COMMANDER SEPAREMENT.

IT I profili vengono forniti con tolleranza +/- 10 mm. Per misure precise si consiglia di ordinare il taglio a misura. L'azienda si riserva la facoltà di apportare variazioni di dati caratteristici, materiali, design, stili, tonalità, senza alcun preavviso.  
EN The profiles are supplied with a tolerance +/- 10 mm. For precise measures, we suggest to order custom cut profiles. The company reserves the right to carry out variations to technical details, materials, design, style, colors with no previous notice.

### DATI TECNICI / TECHNICAL DATA

Codice Code			
P013B-00-A	1020±10*	33x1025±10	0,47 Kg
P013C-00-A	2020±10*	33x2025±10	0,93 Kg
P013D-00-A	3020±10*	33x3025±10	1,3 Kg

LED= MAX 20W/m

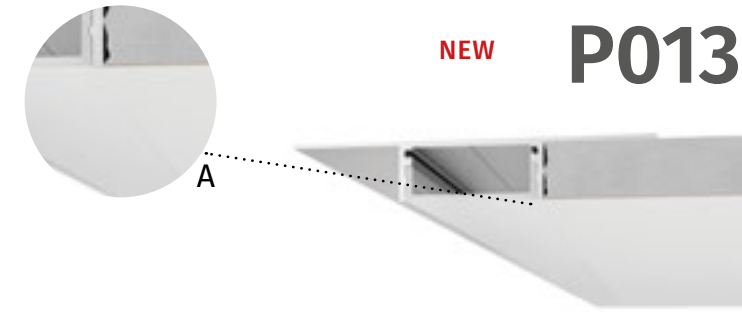

Profilo fornito con schermo opalino di tipo A e senza parte elettrica

EN Profile with included opal diffuser Type A and without electrical part  
DE Profil mit Opaler-Abdeckung Typ A ausgestattet und ohne elektrisches Teil  
FR Profilé équipée avec couverture opale Type A et sans partie électrique

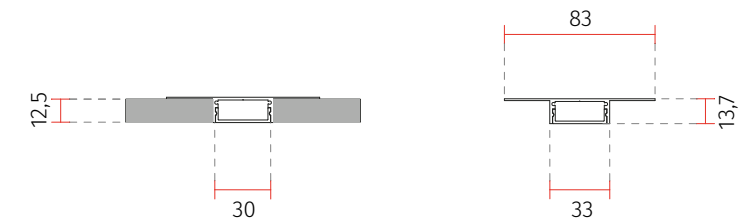

### DATI TECNICI / TECHNICAL DATA

Codice Code			
P013B-00-B	1020±10*	33x1025±10	0,47 Kg
P013C-00-B	2020±10*	33x2025±10	0,93 Kg
P013D-00-B	3020±10*	33x3025±10	1,3 Kg

LED= MAX 20W/m

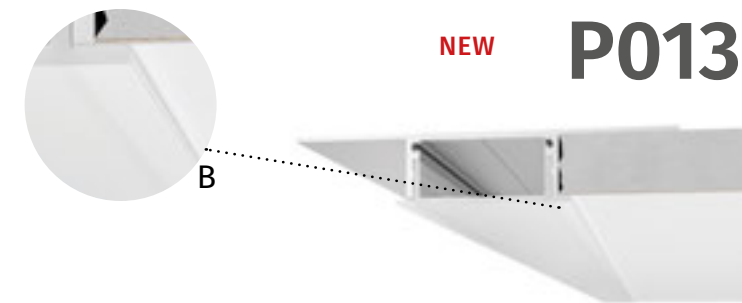

Profilo fornito con schermo opalino di tipo B e senza parte elettrica

EN Profile with included opal diffuser Type B and without electrical part  
DE Profil mit Opaler-Abdeckung Typ B ausgestattet und ohne elektrisches Teil  
FR Profilé équipée avec couverture opale Type B et sans partie électrique

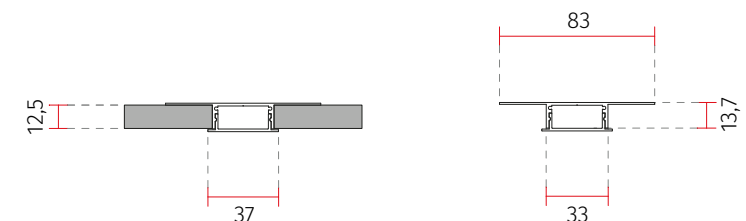

### ACCESSORI / ACCESSORIES

LED Strip		Pg. 398
TGA		Taglio a misura (45°-90°) / Cut to Size (45°-90°) / Zuschnitt (45°-90°) / Coupé à la taille (45°-90°)
TGP		Taglio a progetto (angoli diversi) / Custom Cut (different angles) / Zuschnitt (andere Winkel) / Coupe personnalisée (autres angles)
P013.KIT01		Coppia testate di chiusura / Couple of end caps / 2 Endkappen / 2 tête des profils de terminaux

Ricambio schermo opalino tipo A / Opal plastic cover replacement part type A / Abdeckung in Opalen-Kunststoff Ersatzteil Typ A / Diffuseur opal pièce de rechange type A

029.018.100 1020±10mm

029.018.200 2020±10mm

029.018.300 3020±10mm

Ricambio schermo opalino tipo B / Opal plastic cover replacement part type B / Abdeckung in Opalen-Kunststoff Ersatzteil Typ B / Diffuseur opal pièce de rechange type B

029.019.100 1020±10mm

029.019.200 2020±10mm

029.019.300 3020±10mm

DE Die Profile werden mit einer Toleranz von +/- 10 mm geliefert. Für genaue Abmessungen empfehlen wir den Zuschnitt zu bestellen. Die Firma behält sich das Recht vor ohne Voranmeldung Änderungen an den Werkstoffen, am Design, am Stil und an der Färbung vorzunehmen.  
FR Les profilés sont fournis avec tolérance de +/- 10 mm. Pour des mesures précises, nous vous suggérons de commander coupe personnalisée. La société se réserve le droit de modifier sans préavis les détails techniques, les matériaux, le design, le style et les couleurs.

**PROFILI**  
Profiles  
Profile  
Profilés

ALUMITE®  
made in Italy

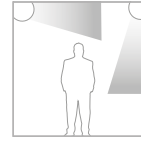

Installabile su legno  
Suitable for Wood

**DATI TECNICI / TECHNICAL DATA**

<b>P015B-00</b>	L 1020±10mm - Senza parte elettrica / Without electrical part / Ohne elektrischen Teil / Sans partie électrique
<b>P015C-00</b>	L 2020±10mm - Senza parte elettrica / Without electrical part / Ohne elektrischen Teil / Sans partie électrique
<b>P015D-00</b>	L 3020±10mm - Senza parte elettrica / Without electrical part / Ohne elektrischen Teil / Sans partie électrique

LED= MAX 10W/m

**ACCESSORI / ACCESSORIES**

<b>LED Strip</b>	Pg. 398
<b>TGA</b>	Taglio a misura (45°-90°) / Cut to Size (45°-90°) / Zuschnitt (45°-90°) / Coupé à la taille (45°-90°)
<b>TGP</b>	Taglio a progetto (angoli diversi) / Custom Cut (different angles) / Zuschnitt (andere Winkel) / Coupe personnalisée (autres angles)

**NEW P015**



Art. P015

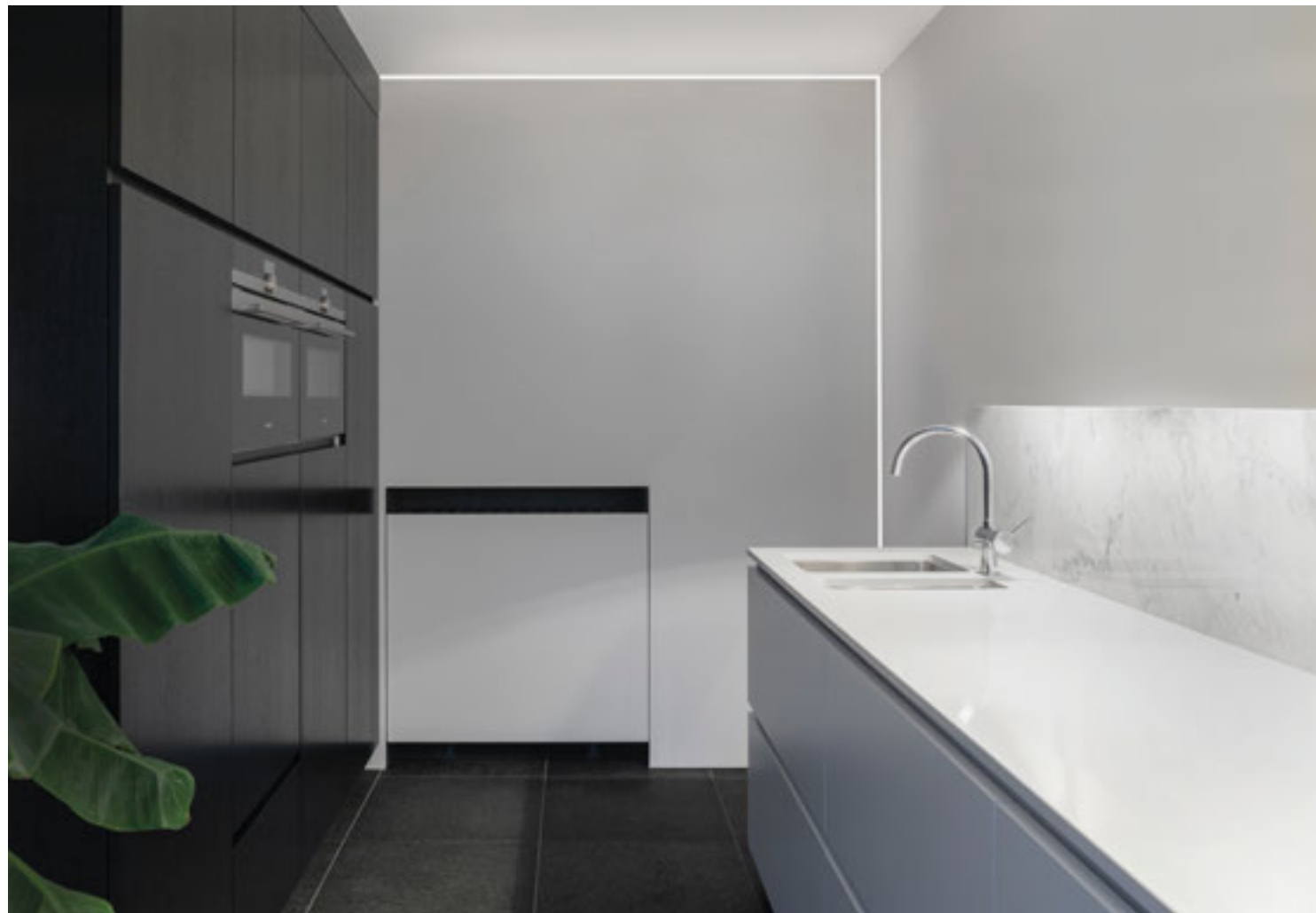

Codice  
Code

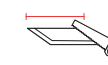
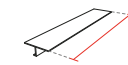

<b>P015B-00</b>	1020±10*	21x1025±10	0,16 Kg
<b>P015C-00</b>	2020±10*	21x2025±10	0,32 Kg
<b>P015D-00</b>	3020±10*	21x3025±10	0,48 Kg

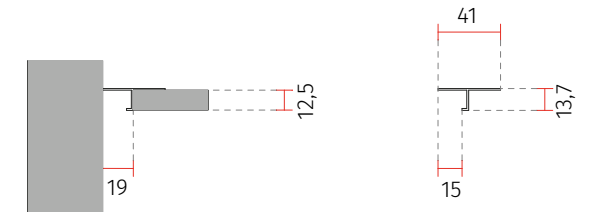

**P015B - P015C - P015D:**

Nella confezione di ogni singolo profilo viene fornito:  
- Profilo in ALUMITE® verniciato ral 9010 opaco;  
STRIP LED 9010 DA ORDINARE SEPARATAMENTE

EN Included in the packaging of each profile:  
- ALUMITE® profile painted ral 9010 matt;  
STRIP LED 9010 TO BE ORDERED SEPARATELY.

DE In der Verpackung der einzelnen Profile ist inbegriffen:  
- ALUMITE® Profil Lackiert Ral 9010 Matt;  
LED STRIP 9010 SEPARAT ZU BESTELLEN.

FR Dans le paquet de chaque profilé est inclus:  
- Profilé en ALUMITE® peint RAL 9010;  
RUBAN LED 9010 A' COMMANDER SEPAREMENT.

IT I profili vengono forniti con tolleranza +/- 10 mm. Per misure precise si consiglia di ordinare il taglio a misura. L'azienda si riserva la facoltà di apportare variazioni di dati caratteristici, materiali, design, stili, tonalità, senza alcun preavviso.  
EN The profiles are supplied with a tolerance +/- 10 mm. For precise measures, we suggest to order custom cut profiles. The company reserves the right to carry out variations to technical details, materials, design, style, colors with no previous notice.

DE Die Profile werden mit einer Toleranz von +/- 10 mm geliefert. Für genaue Abmessungen empfehlen wir den Zuschnitt zu bestellen. Die Firma behält sich das Recht vor ohne Voranmeldung Änderungen an den Werkstoffen, am Design, am Stil und an der Färbung vorzunehmen.  
FR Les profilés sont fournis avec tolérance de +/- 10 mm. Pour des mesures précises, nous vous suggérons de commander coupe personnalisée. La société se réserve le droit de modifier sans préavis les détails techniques, les matériaux, le design, le style et les couleurs.

**SONORE®**

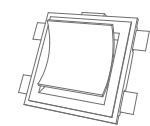

**M001C** p.361

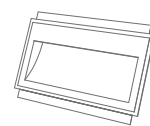

**M002B** p.361

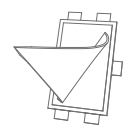

**M003B** p.363

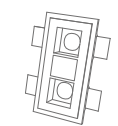

**M004A** p.363

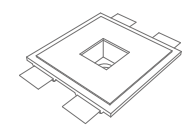

**M005** p.367

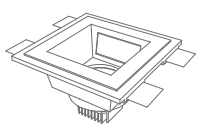

**M006** p.367



**M900A** p.368



**M900B** p.368

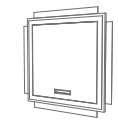

**M900C** p.368

# LUCE E SUONO



**ACUSTICA DI ECCELLENZA**  
HIGH-END ACOUSTICS

**IMMERSIONE SENSORIALE**  
SENSORY IMMERSION

**SISTEMA INTEGRATO**  
FULLY INTEGRATED SYSTEM

La qualità del sistema audio SONORE® è supportata dall'inserimento di componenti integrati harman/kardon®.  
La collezione SONORE® si divide in due tipologie:  
-incasso a parete (M001C – M002B – M003B)  
-Incasso a soffitto (M004A – M005 – M006).

EN The quality of the SONORE® audio system is guaranteed by integrated harman/kardon® components. The SONORE® collection is divided into: - wall recessed products (M001C - M002B - M003B) - Ceiling recessed products (M004A - M005 - M006).  
DE Die Qualität des SONORE®-Audiosystems wird durch die integrierten harman/kardon®-Komponenten garantiert. Die SONORE®-Kollektion umfasst: - Wandeinbauleuchten (M001C - M002B - M003B) - Deckeneinbauleuchten (M004A - M005 - M006).  
FR La qualité du système audio SONORE® est garantie par les composants Harman kardon® intégrés. La collection SONORE® comprend : - produits encastrés muraux (M001C - M002B - M003B) - produits encastrés au plafond (M004A - M005 - M006).

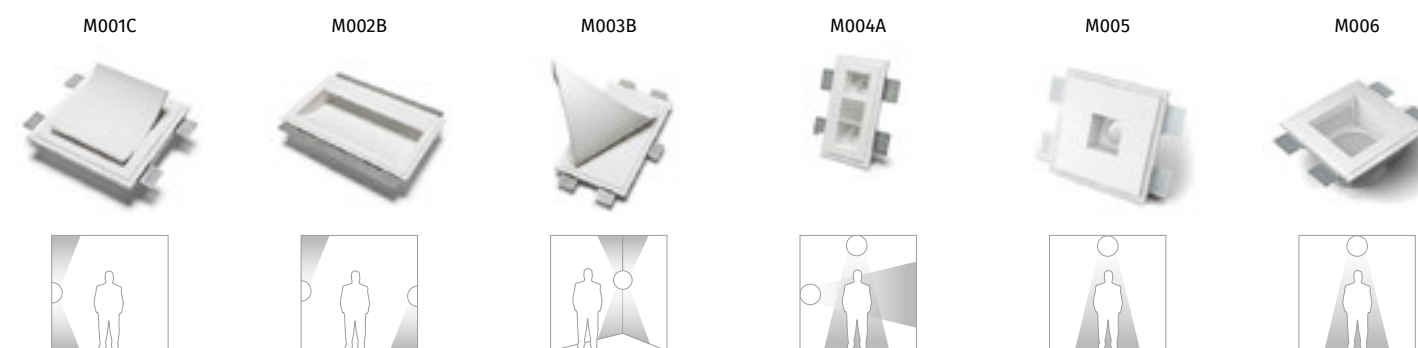

Il SUBWOOFER abbinato a 4 punti luce della collezione SONORE coprirà un'area di circa 60/70 m<sup>2</sup>

The SUBWOOFER combined with 4 lights in the SONORE collection will cover an area of about 60/70 m<sup>2</sup> / Der SUBWOOFER kombiniert mit 4 Leuchten der SONORE-Kollektion umfasst eine Fläche von etwa 60/70 m<sup>2</sup> / Le SUBWOOFER associé aux 4 lampes de la collection SONORE couvre une superficie d'environ 60/70 m<sup>2</sup>

Risposta di frequenza è di 25 - 200 Hz

Frequency Response is 25 - 200 Hz / Frequenzgang beträgt 25 - 200 Hz / Réponse en fréquence de 25 - 200 Hz

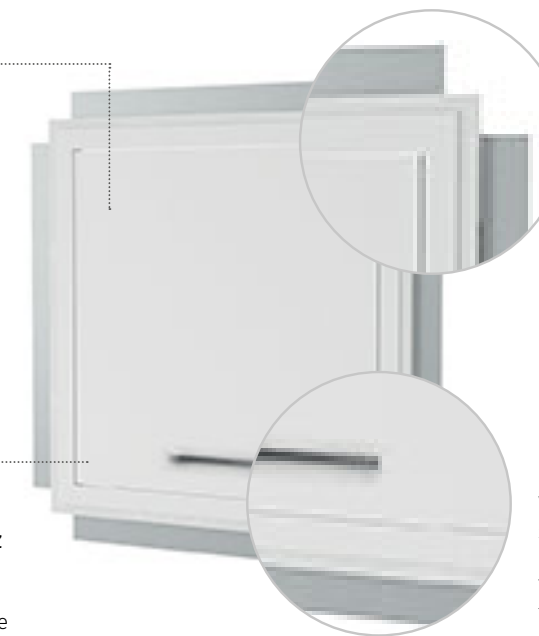

**Alette per facilitare l'incasso a parete**

Metal wings to improve recessed mounting / Metallflügel zur Verbesserung der Einbaumontage / Ailettes métalliques pour améliorer le montage en encastrement

**Questa fessura è l'unico elemento visibile del prodotto installato e serve per la fuoriuscita dei bassi**

This slot is the only visible element of the installed product and grants the bass output. / Dieser Slot ist das einzige sichtbare Element des Produkts und gewährleistet die Bassausgabe / Cette fente est le seul élément visible du produit installé et garantit la sortie des graves.

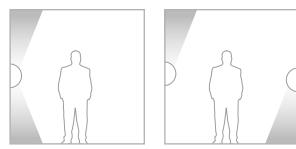

Art. M002B - Private house - Madrid, Spain



DATI TECNICI / TECHNICAL DATA	
M001C-3033	LED 16.5W-700mA-2600lm-3000°K-CRI85
M001C-2733	LED 16.5W-700mA-2450lm-2700°K-CRI85
M001C-4033	LED 16.5W-700mA-2750lm-4000°K-CRI85
026.255	DRIVER ON/OFF min11.9W max18.2W 700mA
026.256	DRIVER ON/OFF min24.9W max35.7W 700mA
026.219	DRIVER DIM PUSH/0-10V/DALI 19.6W 700mA
026.207	DRIVER DIM 0-10V 60.2W 700mA
026.206	DRIVER DIM PUSH/DALI 60.2W 700mA

ACCESSORI / ACCESSORIES	
023.4009	Controcassa per muratura / Housing box for brickwork / Einbaugehäuse für Betonwand / Boîtier pour béton/briques [320x345x85mm]
M900A-00	Subwoofer con ingresso audio da amplificatore esterno / Subwoofer with frequency audio from external amplifier / Subwoofer von externen Verstärkern / Subwoofer avec amplificateur exérier.
M900B-00	Subwoofer con ingresso audio da switch di rete LAN / Subwoofer with audio input from LAN network switch / Subwoofer von LAN Netzwerk-Switch / Subwoofer avec entrée audio commutateur réseauLAN
M900C-00	Subwoofer con ingresso audio da Bluetooth / Subwoofer with audio input from Bluetooth / Subwoofer mit Audiosignale von Bluetooth / Subwoofer avec entrée Bluetooth
099.142	Pg.415 Kit emergenza / Emergency Kit

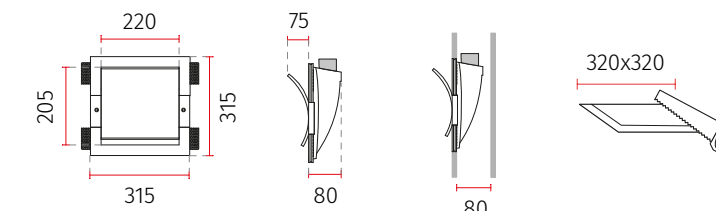

3,7 Kg

Cassa acustica  
Loudspeaker  
Lautsprechergehäuse  
Enceinte audio

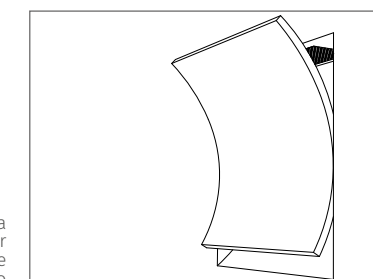

DATI TECNICI / TECHNICAL DATA	
M002B-3034	LED 32W-1050mA-4800lm-3000°K-CRI85
M002B-2734	LED 32W-1050mA-4600lm-2700°K-CRI85
M002B-4034	LED 32W-1050mA-5000lm-4000°K-CRI85
026.220	DRIVER ON/OFF min11.6W max34.7W 1050mA
026.207	DRIVER DIM 0-10V 59.9W 1050mA
026.206	DRIVER DIM PUSH/DALI 59.9W 1050mA

ACCESSORI / ACCESSORIES	
M900A-00	Subwoofer con ingresso audio da amplificatore esterno / Subwoofer with frequency audio from external amplifier / Subwoofer von externen Verstärkern / Subwoofer avec amplificateur exérier.
M900B-00	Subwoofer con ingresso audio da switch di rete LAN / Subwoofer with audio input from LAN network switch / Subwoofer von LAN Netzwerk-Switch / Subwoofer avec entrée audio commutateur réseauLAN
M900C-00	Subwoofer con ingresso audio da Bluetooth / Subwoofer with audio input from Bluetooth / Subwoofer mit Audiosignale von Bluetooth / Subwoofer avec entrée Bluetooth
099.142	Pg.415 Kit emergenza / Emergency Kit

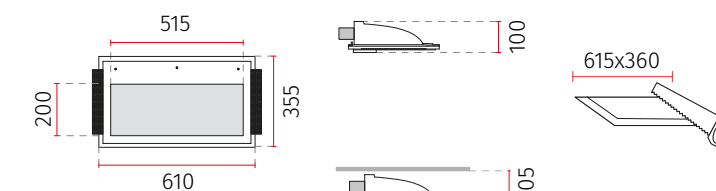

7,5 Kg

Cassa acustica  
Loudspeaker  
Lautsprechergehäuse  
Enceinte audio

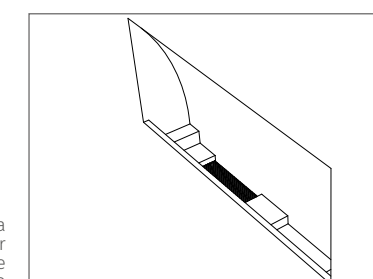

CASSE ACUSTICHE INCLUSE / LOUDSPEAKERS INCLUDED						
Potenza nominale Nominal power Nennleistung Puissance nominale	Potenza di picco Peak power Leistungsspitze Puissance de pointe	Sensibilità Audio sensitivity Audioempfindlichkeit Sensibilité audio	Risposta di frequenza Frequency respons Frequenzbereich Réponse en fréquence	N°Driver	Impedenza Impedance Impedanz Impédance	Cross Over Hi Pass Hi pass Crossover Hochpass-Crossover-Einheit Hi Pass Crossover
40 Wmrs	80 W max	85 dB/oct	200-20000Hz	2	8 Ohm	200Hz 1° ordine

IT Misure espresse in mm, tolleranza +/- 1-2 mm. L'azienda si riserva la facoltà di apportare variazioni di dati caratteristici, materiali, design, stili, tonalità, senza alcun preavviso.  
EN Measures in mm, tollerance +/- 1/2 mm. The company reserves the right to carry out variations to technical details, materials, design, style, colors with no previous notice.

DE Die Masse sind in mm, mit einer Tolleranz von +/- 1-2 mm ausgedrückt, Die Firma behält sich das Recht vor ohne Voranmeldung Änderungen an den Werkstoffen, am Design, am Stil und an der Färbung vorzunehmen.  
FR Mesures en mm, tolérance +/- 1/2 mm. La société se réserve le droit de modifier sans préavis les détails techniques, les matériaux, le design, le style et les couleurs.

# M001C

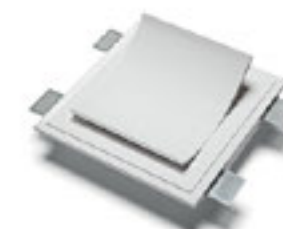

3,7 Kg

# M002B



7,5 Kg

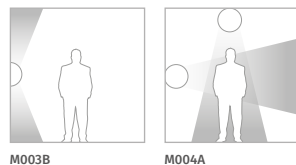

Art. M003B - Private house - Leicester, England



DATI TECNICI / TECHNICAL DATA	
M003B-3008	LED 13W-700mA-1600lm-3000°K-CRI90
M003B-2708	LED 13W-700mA-1500lm-2700°K-CRI90
M003B-4008	LED 13W-700mA-1700lm-4000°K-CRI90
026.255	DRIVER ON/OFF min11.9W max18.2W 700mA
026.256	DRIVER ON/OFF min24.9W max35.7W 700mA
026.219	DRIVER DIM PUSH/0-10V/DALI 19.6W 700mA
026.207	DRIVER DIM 0-10V 60.2W 700mA
026.206	DRIVER DIM PUSH/DALI 60.2W 700mA

ACCESSORI / ACCESSORIES	
M900A-00	Subwoofer con ingresso audio da amplificatore esterno / Subwoofer with frequency audio from external amplifier / Subwoofer von externen Verstärkern / Subwoofer avec amplificateur exérierur.
M900B-00	Subwoofer con ingresso audio da switch di rete LAN / Subwoofer with audio input from LAN network switch / Subwoofer von LAN Netzwerk-Switch / Subwoofer avec entrée audio commutateur réseauLAN
M900C-00	Subwoofer con ingresso audio da Bluetooth / Subwoofer with audio input from Bluetooth / Subwoofer mit Audiosignale von Bluetooth / Subwoofer avec entrée Bluetooth
099.142	Pg.415 Kit emergenza / Emergency Kit

# M003B

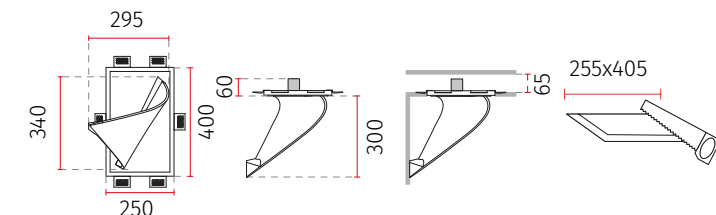

Cassa acustica  
Loudspeaker  
Lautsprechergehäuse  
Enceinte audio

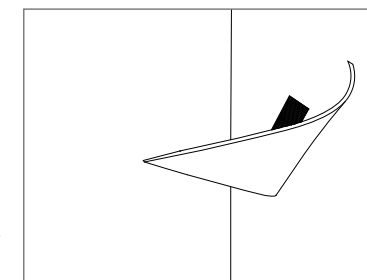

DATI TECNICI / TECHNICAL DATA	
M004A-35	GU10 ø50 MAX 2x35W-240V

ACCESSORI / ACCESSORIES	
L001-3018	LED 8W-220-240V-650lm-3000°K-CRI85-60°
L002-3020	LED 12W-220-240V-1000lm-3000°K-CRI85-60°
L004-3018	LED 8W-220-240V-650lm-3000°K-CRI85-30°
L005-3020	LED 12W-220-240V-1000lm-3000°K-CRI85-30°
M900A-00	Subwoofer con ingresso audio da amplificatore esterno / Subwoofer with frequency audio from external amplifier / Subwoofer von externen Verstärkern / Subwoofer avec amplificateur exérierur.
M900B-00	Subwoofer con ingresso audio da switch di rete LAN / Subwoofer with audio input from LAN network switch / Subwoofer von LAN Netzwerk-Switch / Subwoofer avec entrée audio commutateur réseauLAN
M900C-00	Subwoofer con ingresso audio da Bluetooth / Subwoofer with audio input from Bluetooth / Subwoofer mit Audiosignale von Bluetooth / Subwoofer avec entrée Bluetooth
021.231	Portalamпада / Lampholder /Lampenfassung / Source GU5.3

# M004A

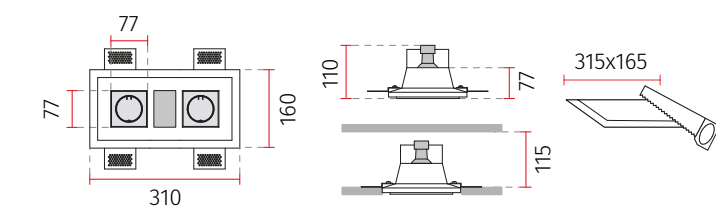

Cassa acustica  
Loudspeaker  
Lautsprechergehäuse  
Enceinte audio

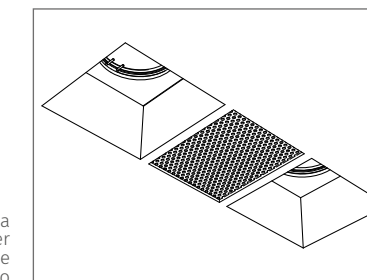

CASSE ACUSTICHE INCLUSE / LOUDSPEAKERS INCLUDED						
Potenza nominale Nominal power Nennleistung Puissance nominale	Potenza di picco Peak power Leistungsspitze Puissance de pointe	Sensibilità Audio sensitivity Audioempfindlichkeit Sensibilité audio	Risposta di frequenza Frequency respons Frequenzbereich Réponse en fréquence	N°Driver	Impedenza Impedance Impedanz Impédance	Cross Over Hi Pass Hi pass Crossover Hochpass-Crossover-Einheit Hi Pass Crossover
40 Wmrs	80 W max	85 dB/oct	200-20000Hz	2	8 Ohm	200Hz 1° ordine

IT Misure espresse in mm, tolleranza +/- 1-2 mm. L'azienda si riserva la facoltà di apportare variazioni di dati caratteristici, materiali, design, stili, tonalità, senza alcun preavviso.  
EN Measures in mm, tollerance +/- 1/2 mm. The company reserves the right to carry out variations to technical details, materials, design, style, colors with no previous notice.

Designer  
**Francesco Stimamiglio**

DE Die Masse sind in mm, mit einer Tolleranz von +/- 1-2 mm ausgedrückt, Die Firma behält sich das Recht vor ohne Voranmeldung Änderungen an den Werkstoffen, am Design, am Stil und an der Färbung vorzunehmen.  
FR Mesures en mm, tolérance +/- 1/2 mm. La société se réserve le droit de modifier sans préavis les détails techniques, les matériaux, le design, le style et les couleurs.



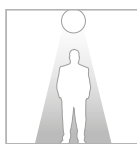

Art. M006 / 4045B / 4199 - Private house - London, UK  
Arch. Francesco Stimamiglio



Diffusore in policarbonato satinato  
satin finish polycarbonate diffuser  
Abdeckung aus satiniertem Polycarbonat  
Diffuseur en polycarbonate satiné

CASSE ACUSTICHE INCLUSE / LOUDSPEAKERS INCLUDED

Potenza nominale Nominal power Nennleistung Puissance nominale	Potenza di picco Peak power Leistungsspitze Puissance de pointe	Sensibilità Audio sensitivity Audioempfindlichkeit Sensibilité audio	Risposta di frequenza Frequency respons Frequenzbereich Réponse en fréquence	N°Driver	Impedenza Impedance Impédance	Cross Over Hi Pass Hi pass Crossover Hochpass-Crossover-Einheit Hi Pass Crossover
40 Wmrs	80 W max	85 dB/oct	200-20000Hz	2	8 Ohm	200Hz 1° ordine

IT Misure espresse in mm, tolleranza +/- 1-2 mm. L'azienda si riserva la facoltà di apportare variazioni di dati caratteristici, materiali, design, stili, tonalità, senza alcun preavviso.  
EN Measures in mm, tolerance +/- 1/2 mm. The company reserves the right to carry out variations to technical details, materials, design, style, colors with no previous notice.

DATI TECNICI / TECHNICAL DATA

M005-35 GU10 Ø50 MAX 35W-240V

ACCESSORI / ACCESSORIES

- L001-3018 LED 8W-220-240V-650lm-3000°K-CRI85-60°
- L002-3020 LED 12W-220-240V-1000lm-3000°K-CRI85-60°
- L004-3018 LED 8W-220-240V-650lm-3000°K-CRI85-30°
- L005-3020 LED 12W-220-240V-1000lm-3000°K-CRI85-30°
- M900A-00 Subwoofer con ingresso audio da amplificatore esterno / Subwoofer with frequency audio from external amplifier / Subwoofer von externen Verstärkern / Subwoofer avec amplificateur exérier.
- M900B-00 Subwoofer con ingresso audio da switch di rete LAN / Subwoofer with audio input from LAN network switch / Subwoofer von LAN Netzwerk-Switch / Subwoofer avec entrée audio commutateur réseauLAN
- M900C-00 Subwoofer con ingresso audio da Bluetooth / Subwoofer with audio input from Bluetooth / Subwoofer mit Audiosignale von Bluetooth / Subwoofer avec entrée Bluetooth
- 021.231 Portalamпада / Lampholder / Lampenfassung / Source GU5.3

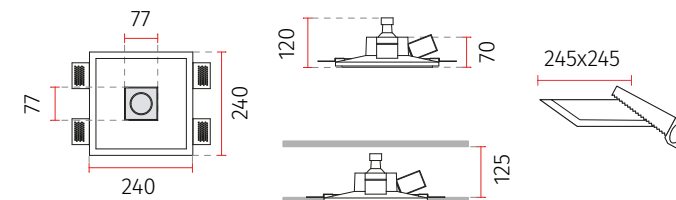

2,2 Kg

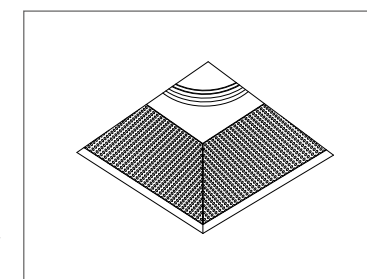

Cassa acustica  
Loudspeaker  
Lautsprechergehäuse  
Enceinte audio

M006

DATI TECNICI / TECHNICAL DATA

- M006-92 G53 (QR111) MAX 20W-12V
- M006-3008 LED 13W-700mA-1600lm-3000°K-CRI90
- M006-2708 LED 13W-700mA-1500lm-2700°K-CRI90
- M006-4008 LED 13W-700mA-1700lm-4000°K-CRI90
- 026.255 DRIVER ON/OFF min11.9W max18.2W 700mA
- 026.256 DRIVER ON/OFF min24.9W max35.7W 700mA
- 026.219 DRIVER DIM PUSH/0-10V/DALI 19.6W 700mA
- 026.207 DRIVER DIM 0-10V 60.2W 700mA
- 026.206 DRIVER DIM PUSH/DALI 60.2W 700mA

ACCESSORI / ACCESSORIES

- M900A-00 Subwoofer con ingresso audio da amplificatore esterno / Subwoofer with frequency audio from external amplifier / Subwoofer von externen Verstärkern / Subwoofer avec amplificateur exérier.
- M900B-00 Subwoofer con ingresso audio da switch di rete LAN / Subwoofer with audio input from LAN network switch / Subwoofer von LAN Netzwerk-Switch / Subwoofer avec entrée audio commutateur réseauLAN
- M900C-00 Subwoofer con ingresso audio da Bluetooth / Subwoofer with audio input from Bluetooth / Subwoofer mit Audiosignale von Bluetooth / Subwoofer avec entrée Bluetooth
- 099.142 Pg.415 Kit emergenza / Emergency Kit

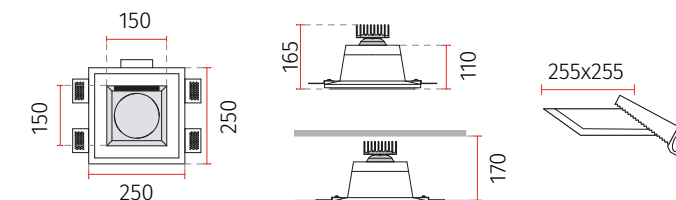

2,55 Kg

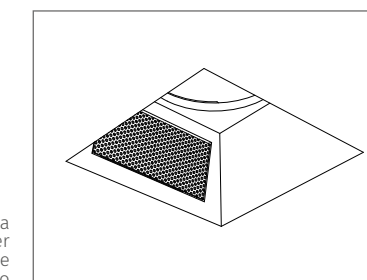

Cassa acustica  
Loudspeaker  
Lautsprechergehäuse  
Enceinte audio



Diffusore in policarbonato satinato  
Satin finish polycarbonate diffuser  
Abdeckung aus satiniertem Polycarbonat  
Diffuseur en polycarbonate satiné

DE Die Masse sind in mm, mit einer Tolleranz von +/- 1-2 mm ausgedrückt, Die Firma behält sich das Recht vor ohne Voranmeldung Änderungen an den Werkstoffen, am Design, am Stil und an der Färbung vorzunehmen.  
FR Mesures en mm, tolérance +/- 1/2 mm. La société se réserve le droit de modifier sans préavis les détails techniques, les matériaux, le design, le style et les couleurs.





17 Kg

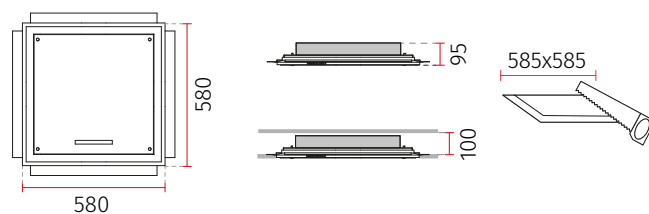

# M900A

Subwoofer con ingresso audio da amplificatore esterno / Subwoofer with frequency audio from external amplifier / Subwoofer von externen Verstärkern / Subwoofer avec amplificateur extérieur

## DATI TECNICI / TECHNICAL DATA

Potenza nominale Nominal power Nennleistung Puissance nominale	Potenza di picco Peak power Leistungsspitze Puissance de pointe	Crossover		Risposta di frequenza Frequency response Frequenzbereich Réponse en fréquence	N° Driver	Impedenza Impedance Impedanz Impédance
		Passa Basso Low pass	Passa Alto High pass			

M900A	60 Wrms per canale	120 W max per canale	/	/	25-200 Hz	1	4 Ohm
-------	--------------------	----------------------	---	---	-----------	---	-------

# M900B

Subwoofer con ingresso audio da switch di rete LAN / Subwoofer with audio input from LAN network switch / Subwoofer von LAN Netzwerk-Switch / Subwoofer avec entrée audio commutateur réseau LAN

## DATI TECNICI / TECHNICAL DATA

Potenza nominale Nominal power Nennleistung Puissance nominale	Potenza di picco Peak power Leistungsspitze Puissance de pointe	Crossover		Risposta di frequenza Frequency response Frequenzbereich Réponse en fréquence	N° Driver	Impedenza Impedance Impedanz Impédance
		Passa Basso Low pass	Passa Alto High pass			

M900B	25x2 + 50x1 Wrms	50x2 + 100x1 W max	200 Hz	200 Hz	25-200 Hz	1	4 Ohm
-------	------------------	--------------------	--------	--------	-----------	---	-------

# M900C

Subwoofer con ingresso audio da Bluetooth / Subwoofer with audio input from Bluetooth / Subwoofer mit Audiosignale von Bluetooth / Subwoofer avec entrée Bluetooth

## DATI TECNICI / TECHNICAL DATA

Potenza nominale Nominal power Nennleistung Puissance nominale	Potenza di picco Peak power Leistungsspitze Puissance de pointe	Crossover		Risposta di frequenza Frequency response Frequenzbereich Réponse en fréquence	N° Driver	Impedenza Impedance Impedanz Impédance
		Passa Basso Low pass	Passa Alto High pass			

M900C	25x2 + 50x1 Wrms	50x2 + 100x1 W max	200 Hz	200 Hz	25-200 Hz	1	4 Ohm
-------	------------------	--------------------	--------	--------	-----------	---	-------

IT Misure espresse in mm, tolleranza +/- 1-2 mm. L'azienda si riserva la facoltà di apportare variazioni di dati caratteristici, materiali, design, stili, tonalità, senza alcun preavviso.  
EN Measures in mm, tolerance +/- 1/2 mm. The company reserves the right to carry out variations to technical details, materials, design, style, colors with no previous notice.

Il sistema audio SONORE® viene proposto in tre modalità con subwoofer da incasso dedicato alla riproduzione di suoni a bassa frequenza.

EN The audio system SONORE® is proposed in three solutions, with recessed subwoofer dedicated to the reproduction of low frequency sounds.  
DE Das Audiosystem SONORE® wird in drei Versionen mit einem Einbau-Subwoofer zur Wiedergabe der Niederfrequenzöne angeboten.  
FR Le système audio SONORE® est proposé en trois modalités avec subwoofer encastrable dédié à la reproduction des sons à basse fréquence.

## AMPLIFICATORE ESTERNO / EXTERNAL AMPLIFIER / EXTERNEN VERSTÄRKERS / AMPLIFICATEUR EXTERIEUR

Sistema passivo con utilizzo di amplificatore esterno, in grado di pilotare da 2 fino a un massimo di 4 prodotti della serie SONORE®, con a bordo il sistema diffusore per le medie alte frequenze.

DE Passives System, mit Verwendung eines EXTERNEN VERSTÄRKERS, zur Steuerung von 2 bis 4 Produkten der Baureihe SONORE®, ausgestattet mit einem Verteilersystem für mittelhohe Frequenzen.

EN Passive system, with use of EXTERNAL AMPLIFIER, able to drive 2 to 4 products from the SONORE® collection, with on board sound diffuser system, for medium high frequencies.

FR Système passif avec utilisation d'un AMPLIFICATEUR EXTERIEUR, en mesure de piloter de 2 à 4 produits de la série SONORE® avec, à bord, le diffuseur pour les moyennes-hautes fréquences.



## SCHEDA DI RETE / NETWORK CARD / NETZKARTE / CARTE RESEAU

Sistema attivo con scheda di rete, in grado di pilotare da 2 fino ad un massimo di 4 prodotti della serie SONORE®, con a bordo il sistema diffusore per le medie alte frequenze. Ideale per zone indipendenti o multiroom gestibili direttamente dalla rete con smartphone, tablet e PC.

DE Aktives System mit NETZKARTE, zur Steuerung von 2 bis 4 Produkten der Baureihe SONORE®, ausgestattet mit einem Verteilersystem für mittel-hohe Frequenzen. Ideal für unabhängige Bereiche oder Mehrzimmereinheiten, kann das System direkt über Smartphone, Tablet oder PC verwaltet werden.

EN Active system with NETWORK CARD, capable of driving 2 to 4 products from the SONORE® collection, with on board sound diffuser system, for medium to high frequencies. The ideal solution for independent areas or multiroom audio, controllable directly from the network with smartphone, tablet and PC.

FR Système actif avec CARTE RESEAU, en mesure de piloter de 2 à 4 produits de la série SONORE® avec, à bord, le diffuseur pour les moyennes-hautes fréquences. Idéal pour zones indépendantes ou multiroom gérables directement via smartphone, tablette et PC.



## BLUETOOTH

Sistema attivo con amplificatore tre canali, completo di bluetooth in grado di pilotare da 2 fino ad un massimo di 4 prodotti della serie SONORE®, con a bordo il sistema per le medie alte frequenze. Ideale per zone indipendenti facilmente gestibili con tecnologia bluetooth presente su tutti i device PC.

DE Aktives System mit Drei-Kanal-Verstärker, komplett mit BLUETOOTH, zur Steuerung von 2 bis 4 Produkten der Baureihe SONORE®, ausgestattet mit einem Verteilersystem für mittel-hohe Frequenzen. Ideal für unabhängige Bereiche, kann das System problemlos mit allen mit Bluetooth vereinbaren Geräten und PCs gesteuert werden.

EN Active system with three channels amplifier, equipped with BLUETOOTH capable of driving 2 to 4 products from the SONORE® collection, with on board sound diffuser system, for medium to high frequencies. The ideal solution for independent areas, controllable with Bluetooth technology present on all devices and PC.





FR Système actif avec amplificateur à trois canaux, doté de BLUETOOTH, en mesure de piloter de 2 à 4 produits de la série SONORE® avec, à bord, le système pour les moyennes-hautes fréquences. Idéal pour zones indépendantes facilement gérables avec la technologie Bluetooth présente sur tous les dispositifs et PC



DE Die Masse sind in mm, mit einer Tolleranz von +/- 1-2 mm ausgedrückt, Die Firma behält sich das Recht vor ohne Voranmeldung Änderungen an den Werkstoffen, am Design, am Stil und an der Färbung vorzunehmen.  
FR Mesures en mm, tolérance +/- 1/2 mm. La société se réserve le droit de modifier sans préavis les détails techniques, les matériaux, le design, le style et les couleurs.

# SOSPENSIONI

Hanging lamps  
 Pendelleuchten  
 Suspensions

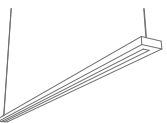
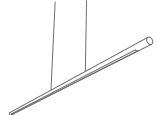
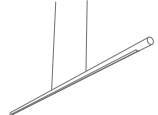
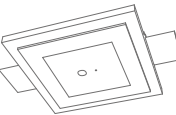
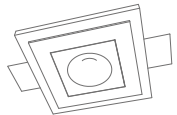
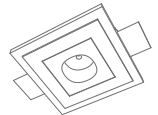
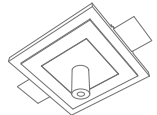
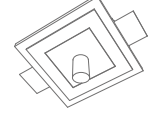
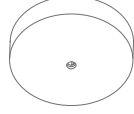
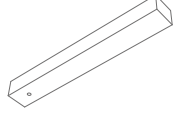
					
5503A p.373	5503B p.373	5507A p.374	5507B p.375	5507C p.375	<b>NEW 5509</b> p.377
					
<b>NEW 5510A</b> p.377	<b>NEW 5510B</b> p.377	5505A p.378	5505B p.379	5505C p.379	5505D p.379
			CAVI COLORATI COLOURED CABLES FARBIGEN KABELN CÂBLES COLORÉS		
5505E p.379	5508A p.381	5508B p.381	020.314 p.381		

# SOSPENSIONI

## Hanging lamps

## Pendelleuchten

## Suspensions

CRISTALY®

made in Italy

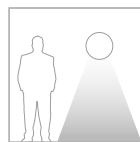

POSSIBILITÀ DI INSTALLAZIONE CON CAVI COLORATI / INSTALLATION WITH COLOURED CABLES AVAILABLE / INSTALLATION MIT FARBIGEN KABELN VERFÜGBAR / INSTALLATION AVEC CÂBLES COLORÉS DISPONIBLES:



Art. 5503B - Private house - Bergamo, Italy



Gli articoli 5503A/B sono forniti con cavo PVC trasparente incluso.

EN The articles 5503A/B are supplied with transparent PVC cable included.

DE Die Artikel 5503A/B werden mit transparentem PVC-Kabel geliefert.

FR Les articles 5503A / B sont fournis avec un câble en PVC transparent inclus.

IT Misure espresse in mm, tolleranza +/- 1-2 mm. L'azienda si riserva la facoltà di apportare variazioni di dati caratteristici, materiali, design, stili, tonalità, senza alcun preavviso.  
EN Measures in mm, tolerance +/- 1/2 mm. The company reserves the right to carry out variations to technical details, materials, design, style, colors with no previous notice.

### DATI TECNICI / TECHNICAL DATA

5503A-35 GU10 Ø50 MAX 10W-240V

### ACCESSORI / ACCESSORIES

5508A-00	Pg.381 Rosone ad appoggio / Ceiling Rose / Deckenrosette / Rosace Plafond Ø130x25mm
5505A-00	Pg.378 Rosone a scomparsa / Recessed Ceiling Rose / Einbau/Deckenrosette / Rosace encastré
5505B-00	Pg.379 Rosone a scomparsa / Recessed Ceiling Rose / Einbau/Deckenrosette / Rosace encastré
5505C-00	Pg.379 Rosone a scomparsa / Recessed Ceiling Rose / Einbau/Deckenrosette / Rosace encastré
5505D-00	Pg.379 Rosone a scomparsa / Recessed Ceiling Rose / Einbau/Deckenrosette / Rosace encastré
5505E-00	Pg.379 Rosone a scomparsa / Recessed Ceiling Rose / Einbau/Deckenrosette / Rosace encastré
020.314	Pg.381 Cavi colorati / Coloured cables / farbigen Kabel / câbles colorés

5503A

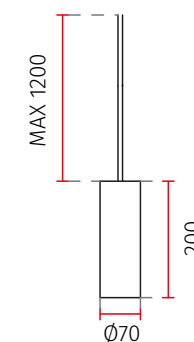

Rosone non incluso nella confezione / Ceiling rose not included in the packaging / Deckenrosette nicht einbegriffen / Rosace de plafond non inclus

### DATI TECNICI / TECHNICAL DATA

5503B-35 GU10 Ø50 MAX 10W-240V

### ACCESSORI / ACCESSORIES

5508A-00	Pg.381 Rosone ad appoggio / Ceiling Rose / Deckenrosette / Rosace Plafond Ø130x25mm
5505A-00	Pg.378 Rosone a scomparsa / Recessed Ceiling Rose / Einbau/Deckenrosette / Rosace encastré
5505B-00	Pg.379 Rosone a scomparsa / Recessed Ceiling Rose / Einbau/Deckenrosette / Rosace encastré
5505C-00	Pg.379 Rosone a scomparsa / Recessed Ceiling Rose / Einbau/Deckenrosette / Rosace encastré
5505D-00	Pg.379 Rosone a scomparsa / Recessed Ceiling Rose / Einbau/Deckenrosette / Rosace encastré
5505E-00	Pg.379 Rosone a scomparsa / Recessed Ceiling Rose / Einbau/Deckenrosette / Rosace encastré
020.314	Pg.381 Cavi colorati / Coloured cables / farbigen Kabel / câbles colorés

5503B

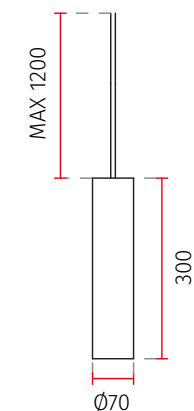

Rosone non incluso nella confezione / Ceiling rose not included in the packaging / Deckenrosette nicht einbegriffen / Rosace de plafond non inclus

DE Die Masse sind in mm, mit einer Tolleranz von +/- 1-2 mm ausgedrückt, Die Firma behält sich das Recht vor ohne Voranmeldung Änderungen an den Werkstoffen, am Design, am Stil und an der Färbung vorzunehmen.  
FR Mesures en mm, tolérance +/- 1/2 mm. La société se réserve le droit de modifier sans préavis les détails techniques, les matériaux, le design, le style et les couleurs.

# SOSPENSIONI

## Hanging lamps

## Pendelleuchten

## Suspensions

CRISTALY®

made in Italy

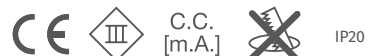
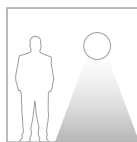

POSSIBILITÀ DI INSTALLAZIONE CON CAVI COLORATI / INSTALLATION WITH COLOURED CABLES AVAILABLE / INSTALLATION MIT FARBIGEN KABELN VERFÜGBAR / INSTALLATION AVEC CÂBLES COLORÉS DISPONIBLES:



Art. 5507C



Gli articoli 5507 sono forniti con cavo PVC trasparente incluso.

EN The articles 5507 are supplied with transparent PVC cable included.  
DE Die Artikel 5507 werden mit transparentem PVC-Kabel geliefert.  
FR Les articles 5507 sont fournis avec un câble en PVC transparent inclus.



### DATI TECNICI / TECHNICAL DATA

5507B-3039	LED 4W-350mA-350lm-3000°K-CRI85
5507B-2739	LED 4W-350mA-330lm-2700°K-CRI85
5507B-4039	LED 4W-350mA-370lm-4000°K-CRI85
026.250	DRIVER ON/OFF min2.8W max4.2W 350mA
026.251	DRIVER ON/OFF min6W max8.8W 350mA
026.236	DRIVER ON/OFF min8.8W max12W 350mA
026.252	DRIVER ON/OFF min12.6W max18.2W 350mA
026.221	DRIVER ON/OFF min9.8W max35W 350mA
026.219	DRIVER DIM PUSH/0-10V/DALI 16.1W 350mA
026.187	DRIVER DIM 0-10V 35W 350mA
026.185	DRIVER DIM PUSH/DALI 35W 350mA

### ACCESSORI / ACCESSORIES

5508A-00	Pg.381 Rosone ad appoggio / Ceiling Rose / Deckenrosette / Rosace Plafond Ø130x25mm
5505A-00	Pg.378 Rosone a scomparsa / Recessed Ceiling Rose / Einbau/Deckenrosette / Rosace encastré
5505B-00	Pg.379 Rosone a scomparsa / Recessed Ceiling Rose / Einbau/Deckenrosette / Rosace encastré
5505C-00	Pg.379 Rosone a scomparsa / Recessed Ceiling Rose / Einbau/Deckenrosette / Rosace encastré
5505D-00	Pg.379 Rosone a scomparsa / Recessed Ceiling Rose / Einbau/Deckenrosette / Rosace encastré
5505E-00	Pg.379 Rosone a scomparsa / Recessed Ceiling Rose / Einbau/Deckenrosette / Rosace encastré
099.142	Pg.415 Kit emergenza / Emergency Kit
020.314	Pg.381 Cavi colorati / Coloured cables / farbigen Kabel / câbles colorés

5507B



0,5 Kg

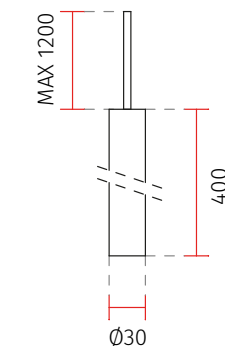

Rosone non incluso nella confezione / Ceiling rose not included in the packaging / Deckenrosette nicht einbezogen / Rosace de plafond non inclus

5507A



0,3 Kg

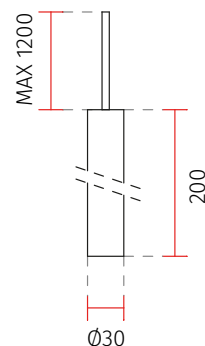

### DATI TECNICI / TECHNICAL DATA

5507A-3039	LED 4W-350mA-350lm-3000°K-CRI85
5507A-2739	LED 4W-350mA-330lm-2700°K-CRI85
5507A-4039	LED 4W-350mA-370lm-4000°K-CRI85
026.250	DRIVER ON/OFF min2.8W max4.2W 350mA
026.251	DRIVER ON/OFF min6W max8.8W 350mA
026.236	DRIVER ON/OFF min8.8W max12W 350mA
026.252	DRIVER ON/OFF min12.6W max18.2W 350mA
026.221	DRIVER ON/OFF min9.8W max35W 350mA
026.219	DRIVER DIM PUSH/0-10V/DALI 16.1W 350mA
026.187	DRIVER DIM 0-10V 35W 350mA
026.185	DRIVER DIM PUSH/DALI 35W 350mA

### ACCESSORI / ACCESSORIES

5508A-00	Pg.381 Rosone ad appoggio / Ceiling Rose / Deckenrosette / Rosace Plafond Ø130x25mm
5505A-00	Pg.378 Rosone a scomparsa / Recessed Ceiling Rose / Einbau/Deckenrosette / Rosace encastré
5505B-00	Pg.379 Rosone a scomparsa / Recessed Ceiling Rose / Einbau/Deckenrosette / Rosace encastré
5505C-00	Pg.379 Rosone a scomparsa / Recessed Ceiling Rose / Einbau/Deckenrosette / Rosace encastré
5505D-00	Pg.379 Rosone a scomparsa / Recessed Ceiling Rose / Einbau/Deckenrosette / Rosace encastré
5505E-00	Pg.379 Rosone a scomparsa / Recessed Ceiling Rose / Einbau/Deckenrosette / Rosace encastré
099.142	Pg.415 Kit emergenza / Emergency Kit
020.314	Pg.381 Cavi colorati / Coloured cables / farbigen Kabel / câbles colorés

Rosone non incluso nella confezione / Ceiling rose not included in the packaging / Deckenrosette nicht einbezogen / Rosace de plafond non inclus

IT Misure espresse in mm, tolleranza +/- 1-2 mm. L'azienda si riserva la facoltà di apportare variazioni di dati caratteristici, materiali, design, stili, tonalità, senza alcun preavviso.  
EN Measures in mm, tolerance +/- 1/2 mm. The company reserves the right to carry out variations to technical details, materials, design, style, colors with no previous notice.

### DATI TECNICI / TECHNICAL DATA

5507C-3039	LED 4W-350mA-350lm-3000°K-CRI85
5507C-2739	LED 4W-350mA-330lm-2700°K-CRI85
5507C-4039	LED 4W-350mA-370lm-4000°K-CRI85
026.250	DRIVER ON/OFF min2.8W max4.2W 350mA
026.251	DRIVER ON/OFF min6W max8.8W 350mA
026.236	DRIVER ON/OFF min8.8W max12W 350mA
026.252	DRIVER ON/OFF min12.6W max18.2W 350mA
026.221	DRIVER ON/OFF min9.8W max35W 350mA
026.219	DRIVER DIM PUSH/0-10V/DALI 16.1W 350mA
026.187	DRIVER DIM 0-10V 35W 350mA
026.185	DRIVER DIM PUSH/DALI 35W 350mA

### ACCESSORI / ACCESSORIES

5508A-00	Pg.381 Rosone ad appoggio / Ceiling Rose / Deckenrosette / Rosace Plafond Ø130x25mm
5505A-00	Pg.378 Rosone a scomparsa / Recessed Ceiling Rose / Einbau/Deckenrosette / Rosace encastré
5505B-00	Pg.379 Rosone a scomparsa / Recessed Ceiling Rose / Einbau/Deckenrosette / Rosace encastré
5505C-00	Pg.379 Rosone a scomparsa / Recessed Ceiling Rose / Einbau/Deckenrosette / Rosace encastré
5505D-00	Pg.379 Rosone a scomparsa / Recessed Ceiling Rose / Einbau/Deckenrosette / Rosace encastré
5505E-00	Pg.379 Rosone a scomparsa / Recessed Ceiling Rose / Einbau/Deckenrosette / Rosace encastré
099.142	Pg.415 Kit emergenza / Emergency Kit
020.314	Pg.381 Cavi colorati / Coloured cables / farbigen Kabel / câbles colorés

5507C



0,7 Kg

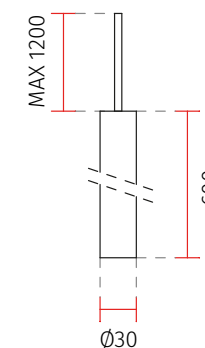

Rosone non incluso nella confezione / Ceiling rose not included in the packaging / Deckenrosette nicht einbezogen / Rosace de plafond non inclus

DE Die Masse sind in mm, mit einer Tolleranz von +/- 1-2 mm ausgedrückt. Die Firma behält sich das Recht vor ohne Voranmeldung Änderungen an den Werkstoffen, am Design, am Stil und an der Färbung vorzunehmen.  
FR Mesures en mm, tolérance +/- 1/2 mm. La société se réserve le droit de modifier sans préavis les détails techniques, les matériaux, le design, le style et les couleurs.

# SOSPENSIONI

## Hanging lamps

## Pendelleuchten

## Suspensions

CRISTALY<sup>®</sup><sub>1000</sub>  
ALUMITE<sup>®</sup><sub>9910</sub>

made in Italy

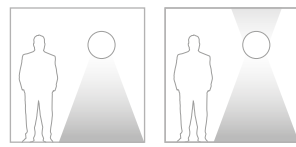

5509/5510A

5510B



IP20

POSSIBILITÀ DI INSTALLAZIONE CON CAVI COLORATI / INSTALLATION WITH COLOURED CABLES AVAILABLE / INSTALLATION MIT FARBIGEN KABELN VERFÜGBAR / INSTALLATION AVEC CÂBLES COLORÉS DISPONIBLES:



### DATI TECNICI / TECHNICAL DATA

5510A-30147	LED 39W-220-240V-4500lm-3000°K-CRI85
5510A-27147	LED 39W-220-240V-4250lm-2700°K-CRI85
5510A-40147	LED 39W-220-240V-4750lm-4000°K-CRI85

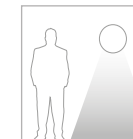

NEW 5510A

Art. 5510B



0,9 Kg

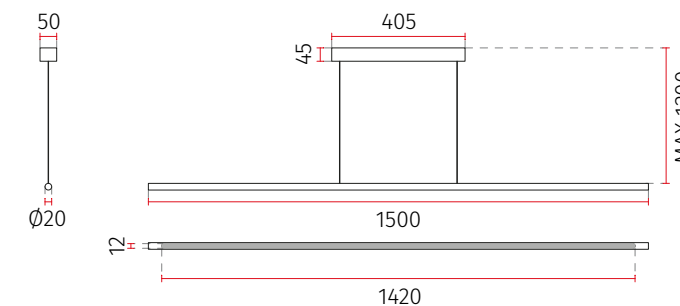

5509 NEW



2,65 Kg

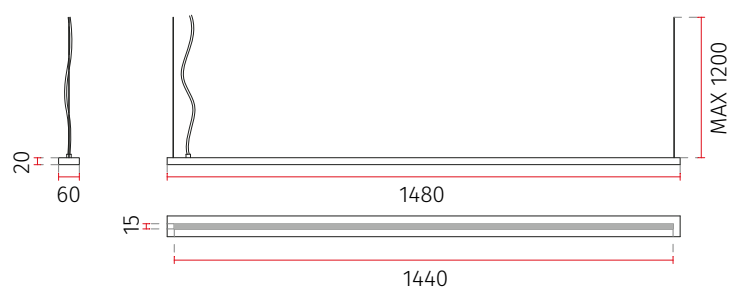

### DATI TECNICI / TECHNICAL DATA

5509-3003	LED 39W-24Vdc-4500lm-3000°K-CRI90
5509-2703	LED 39W-24Vdc-4300lm-2700°K-CRI90
5509-4003	LED 39W-24Vdc-4700lm-4000°K-CRI90
026.267	DRIVER ON/OFF 60W 24V
026.209	DRIVER DIM PUSH/1-10V 60W 24V
026.190+026.261	DRIVER DIM PUSH/0-10V/DALI 150W 24V
026.190+026.262	DRIVER DIM PUSH/0-10V/DALI 240W 24V

### ACCESSORI / ACCESSORIES

5508B-00	Pg.381 Rosone ad appoggio / Ceiling Rose / Deckenrosette / Rosace Plafond 400x50xH40mm
2x5505A-00	Pg.379 Rosone a scomparsa / Recessed Ceiling Rose / Einbau/Deckenrosette / Rosace encastré
2x5505B-00	Pg.379 Rosone a scomparsa / Recessed Ceiling Rose / Einbau/Deckenrosette / Rosace encastré
2x5505C-00	Pg.379 Rosone a scomparsa / Recessed Ceiling Rose / Einbau/Deckenrosette / Rosace encastré
2x5505D-00	Pg.379 Rosone a scomparsa / Recessed Ceiling Rose / Einbau/Deckenrosette / Rosace encastré
2x5505E-00	Pg.379 Rosone a scomparsa / Recessed Ceiling Rose / Einbau/Deckenrosette / Rosace encastré
020.314	Pg.381 Cavi colorati / Coloured cables / farbigen Kabel / câbles colorés

L'articolo 5509 sono forniti con cavo PVC trasparente incluso.

EN The article 5509 is supplied with transparent PVC cable included.

DE Der Artikel 5509 wird mit transparentem PVC-Kabel geliefert.

FR L'article 5509 est fourni avec un câble en PVC transparent inclus.

IT Misure espresse in mm, tolleranza +/- 1-2 mm. L'azienda si riserva la facoltà di apportare variazioni di dati caratteristici, materiali, design, stili, tonalità, senza alcun preavviso.  
EN Measures in mm, tolerance +/- 1/2 mm. The company reserves the right to carry out variations to technical details, materials, design, style, colors with no previous notice.

### DATI TECNICI / TECHNICAL DATA

5510B-30148	LED 39W-220-240V-4500lm-3000°K-CRI85
5510B-27148	LED 39W-220-240V-4250lm-2700°K-CRI85
5510B-40148	LED 39W-220-240V-4750lm-4000°K-CRI85



NEW 5510B

0,7 Kg

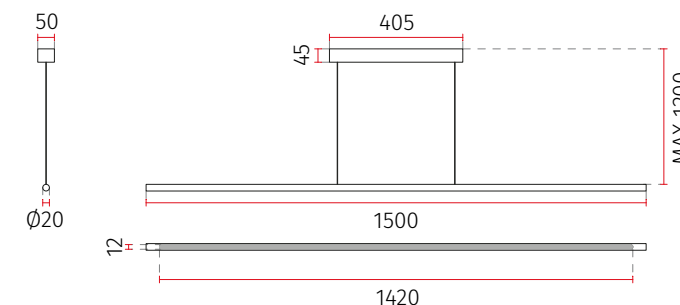

DE Die Masse sind in mm, mit einer Tolleranz von +/- 1-2 mm ausgedrückt, Die Firma behält sich das Recht vor ohne Voranmeldung Änderungen an den Werkstoffen, am Design, am Stil und an der Färbung vorzunehmen.  
FR Mesures en mm, tolérance +/- 1/2 mm. La société se réserve le droit de modifier sans préavis les détails techniques, les matériaux, le design, le style et les couleurs.

# ACCESSORI

Accessories  
Zubehöre  
Accessoires

CRISTALY® made in Italy



## VERSIONE CON ACCESSORI 5505 / VERSION WITH ACCESSORY 5505 / VERSION MIT ZUBEHÖR 5505 / VERSION AVEC ACCESSOIRE 5505

Inserendo l'alimentatore in una scatola di derivazione remota, gli accessori 5505 permettono nel caso di controsoffitti in cartongesso di eliminare il rosone dal soffitto ed avere un aggancio semplice e minimale.

EN Inserting the driver into a remote box, the articles 5505 grants a simple and minimal connection, in case of plaster ceilings, and substitute the ceiling rose.

DE Beim Einsetzen des Betriebsgeräts in einen Schaltkasten, gewährt der Artikel 5505 einen einfachen und minimalen Anschluss an die Gipskartondecke, was die Deckenrosette ersetzt.

FR En insérant l'alimentation dans une boîte de dérivation, les accessoires 5505 permettent, dans le cas de faux plafond, d'éliminer la rosace dans celle-ci et d'avoir une connection simple et minimaliste.

1.

**Installare cornice**  
Insert the frame  
Rahmen einsetzen  
Installer le cadre

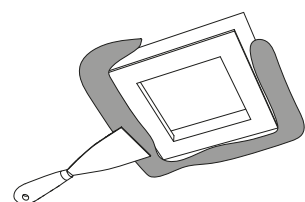

2.

**Regolare cavo**  
Adjust cable length  
Kabel einstellen  
Ajuster le cable

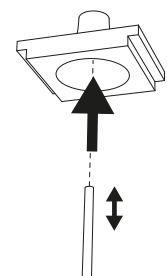

3.

**Posizionare inserto del rosone**  
Insert the ceiling rose  
Deckenrosette einsetzen  
Positionner la rosace au plafond

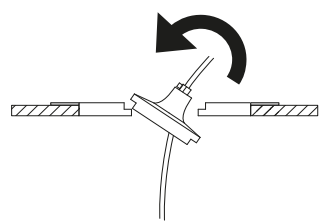

4.

**Stuccare**  
Finish  
Verputzen  
Enduire

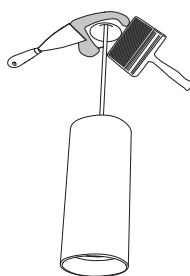

## 5505A

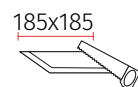
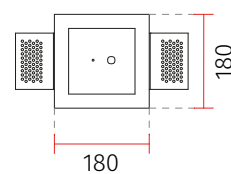

### DATI TECNICI / TECHNICAL DATA

5505A-00 Rosone a scomparsa / Recessed Ceiling Rose / Einbau/Deckenrosette / Rosace encastré

### ACCESSORI / ACCESSORIES

023.448 Controcassa per muratura / Housing box for brickwork / Einbaugeschäuse für Betonwand / Boîtier pour béton/briques [190x190x125mm]

### DATI TECNICI / TECHNICAL DATA

5505B-00 Rosone a scomparsa / Recessed Ceiling Rose / Einbau/Deckenrosette / Rosace encastré

### ACCESSORI / ACCESSORIES

023.448 Controcassa per muratura / Housing box for brickwork / Einbaugeschäuse für Betonwand / Boîtier pour béton/briques [190x190x125mm]

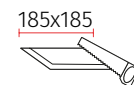
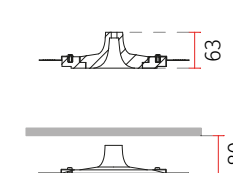
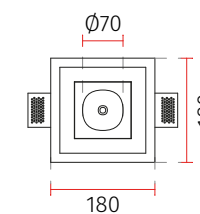

## 5505C

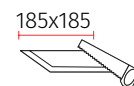
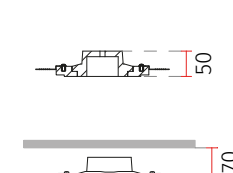
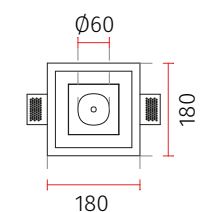

### DATI TECNICI / TECHNICAL DATA

5505C-00 Rosone a scomparsa / Recessed Ceiling Rose / Einbau/Deckenrosette / Rosace encastré

### ACCESSORI / ACCESSORIES

023.448 Controcassa per muratura / Housing box for brickwork / Einbaugeschäuse für Betonwand / Boîtier pour béton/briques [190x190x125mm]

### DATI TECNICI / TECHNICAL DATA

5505D-00 Rosone a scomparsa / Recessed Ceiling Rose / Einbau/Deckenrosette / Rosace encastré

### ACCESSORI / ACCESSORIES

023.448 Controcassa per muratura / Housing box for brickwork / Einbaugeschäuse für Betonwand / Boîtier pour béton/briques [190x190x125mm]

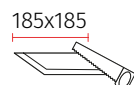
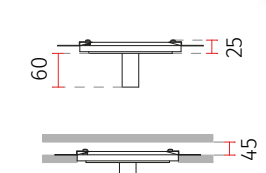
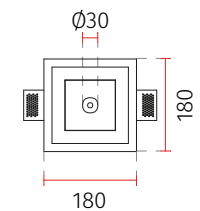

### DATI TECNICI / TECHNICAL DATA

5505E-00 Rosone a scomparsa / Recessed Ceiling Rose / Einbau/Deckenrosette / Rosace encastré

### ACCESSORI / ACCESSORIES

023.448 Controcassa per muratura / Housing box for brickwork / Einbaugeschäuse für Betonwand / Boîtier pour béton/briques [190x190x125mm]

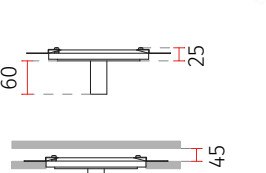
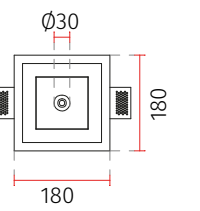

**ACCESSORI**  
Accessories  
Zubehöre  
Accessoires

CRISTALY® made in Italy



**VERSIONE CON ACCESSORI 5508 / VERSION WITH ACCESSORY 5508 /  
VERSION MIT ZUBEHÖR 5508 / VERSION AVEC ACCESSOIRE 5508**

L'installazione delle sospensioni 9010 tramite gli accessori 5508 permette di posizionare l'alimentatore direttamente all'interno del rosone.

EN The installation of the 9010 hanging lamps with the 5508 accessory grants the installation of the driver inside the ceiling rose.

DE Die Installation der 9010-Hängelampen mit dem Zubehör 5508 ermöglicht die Installation des Treibers in der Deckenrosette.

FR L'installation des suspensions 9010 avec l'accessoire 5508 garantit l'installation de l'alimentation dans la rosace.

**1.**

**Regolare cavo**  
Adjust cable length  
Kabel einstellen  
Ajuster le câble

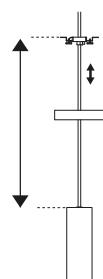

**2.**

**Fissare staffa**  
Fix the bracket  
Halterung befestigen  
Fixer le support

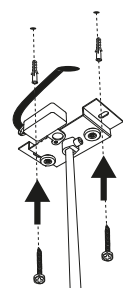

**3.**

**Fissare rosone con aggancio magnetico**  
Fix the ceiling rose with the magnetic system  
Befestigen Sie die Deckenrose mit dem Magnetsystem  
Fixer la rosace avec le système magnétique

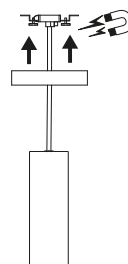

**4.**

**Risultato finale**  
Final result  
Endergebnis  
Résultat final

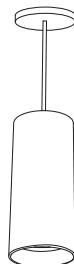

**DATI TECNICI / TECHNICAL DATA**

5508A-00 Rosone ad appoggio / Ceiling Rose / Deckenrosette / Rosace Plafond  
Ø130x25mm

**5508A**



0,4 Kg

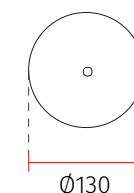

**DATI TECNICI / TECHNICAL DATA**

5508B-00 Rosone ad appoggio / Ceiling Rose / Deckenrosette / Rosace Plafond  
400x50xH40mm

**5508B**



1,2 Kg

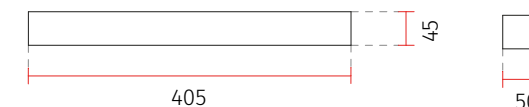

**Cavi colorati per sospensioni: / Coloured cables for Hanging lamps: /  
Farbige Kabel für Hängelampe: / Câbles colorés pour Suspensions:**

**DATI TECNICI / TECHNICAL DATA**

020.314B Bianco - White  
020.314G Giallo - Yellow  
020.314N Nero - Black  
020.314R Rosso - Red  
020.314V Verde - Green

**020.314**



**020.314 sezione del cavo mm 7 lunghezza cavo m 1.3 / section of the cable mm 7 cable length m 1.3 /  
Kabelabschnitt mm 7 Kabellänge m 1.3 / section du câble mm 7 longueur du câble m 1.3**

IT Misure espresse in mm, tolleranza +/- 1-2 mm. L'azienda si riserva la facoltà di apportare variazioni di dati caratteristici, materiali, design, stili, tonalità, senza alcun preavviso.  
EN Measures in mm, tolerance +/- 1/2 mm. The company reserves the right to carry out variations to technical details, materials, design, style, colors with no previous notice.

DE Die Masse sind in mm, mit einer Tolleranz von +/- 1-2 mm ausgedrückt, Die Firma behält sich das Recht vor ohne Voranmeldung Änderungen an den Werkstoffen, am Design, am Stil und an der Färbung vorzunehmen.  
FR Mesures en mm, tolérance +/- 1/2 mm. La société se réserve le droit de modifier sans préavis les détails techniques, les matériaux, le design, le style et les couleurs.

## LAMPADE DA TAVOLO

Table lamps

Tischleuchten

Lampes de table

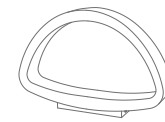

2623T p.384



**NEW 5289A** p.384



**NEW 5289B** p.384



**NEW 5290** p.385

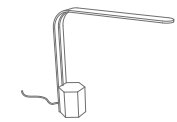

**NEW 5291** p.385



# LAMPADE DA TAVOLO

Table lamps  
Tischleuchten  
Lampes de table

CRISTALY®

made in Italy

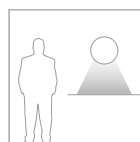

## DATI TECNICI / TECHNICAL DATA

2623T-3035	LED 2x6.5W-220-240V-1800lm-3000°K-CRI90
2623T-2735	LED 2x6.5W-220-240V-1730lm-2700°K-CRI90
2623T-4035	LED 2x6.5W-220-240V-1870lm-4000°K-CRI90

Designer  
**Itamar Harari**

## 2623T

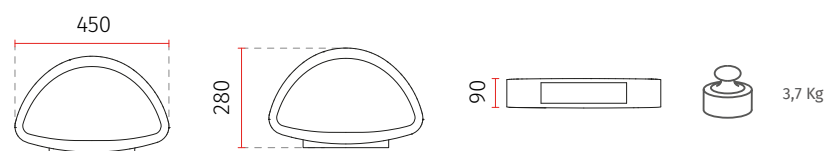

## DATI TECNICI / TECHNICAL DATA

5290-35	GU10 ø50 MAX 10W-240V
---------	-----------------------

Designer  
**Alberto Ghirardello**  
>SHARD

## NEW 5290

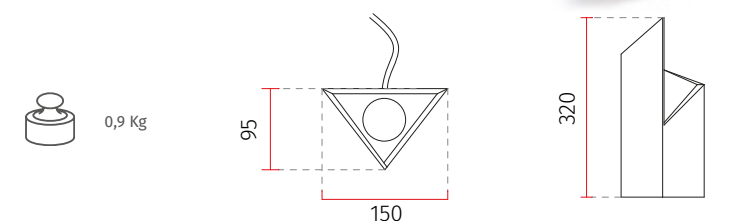

## 5289A NEW

## DATI TECNICI / TECHNICAL DATA

5289A-42	E27 10W-240V L105mm
----------	---------------------

Designer  
**Alberto Ghirardello**  
>FLAT

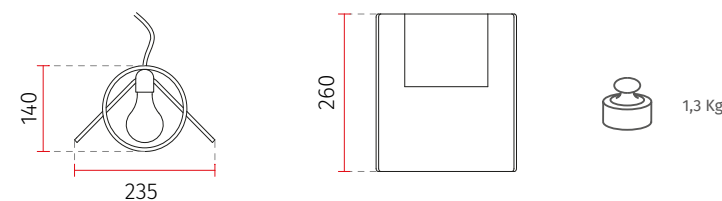

Diffusore in policarbonato opalino  
Opal finish polycarbonate diffuser  
Abdeckung aus opalem Polycarbonat  
Diffuseur en polycarbonate opaline



## DATI TECNICI / TECHNICAL DATA

5291-3045	LED 8W-220-240V-900lm-3000°K-CRI90
5291-2745	LED 8W-220-240V-850lm-2700°K-CRI90
5291-4045	LED 8W-220-240V-950lm-4000°K-CRI90

Designer  
**Matteo Beraldi**  
>LINEAR

## NEW 5291

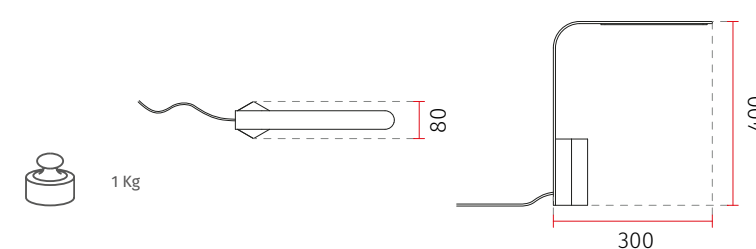

## 5289B NEW

## DATI TECNICI / TECHNICAL DATA

5289B-42	E27 10W-240V L105mm
----------	---------------------

Designer  
**Alberto Ghirardello**  
>FLAT

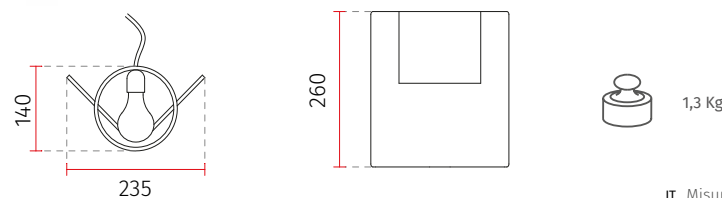

Diffusore in policarbonato opalino  
Opal finish polycarbonate diffuser  
Abdeckung aus opalem Polycarbonat  
Diffuseur en polycarbonate opaline



IT Misure espresse in mm, tolleranza +/- 1-2 mm. L'azienda si riserva la facoltà di apportare variazioni di dati caratteristici, materiali, design, stili, tonalità, senza alcun preavviso.  
EN Measures in mm, tolerance +/- 1/2 mm. The company reserves the right to carry out variations to technical details, materials, design, style, colors with no previous notice.

DE Die Masse sind in mm, mit einer Tolleranz von +/- 1-2 mm ausgedrückt, Die Firma behält sich das Recht vor ohne Voranmeldung Änderungen an den Werkstoffen, am Design, am Stil und an der Färbung vorzunehmen.  
FR Mesures en mm, tolérance +/- 1/2 mm. La société se réserve le droit de modifier sans préavis les détails techniques, les matériaux, le design, le style et les couleurs.



# DA ESTERNO

Outdoor Lamps  
Aussenleuchten  
Lampes d'extérieur

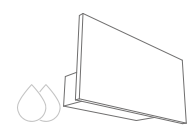

1090 p.391

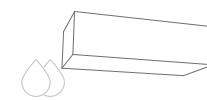

1091 p.391



1092 p.391

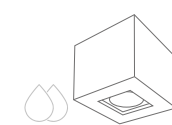

1094 p.391

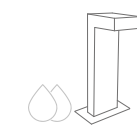

1093 p. 393

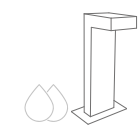

1093B p. 393



IP65

**DA ESTERNO**  
Outdoor Lamps  
Aussenleuchten  
Lampes d'extérieur

CONCRETE®<sup>9000</sup> made in Italy

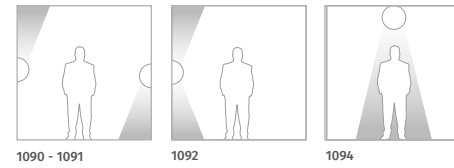

■ **COLORI DEI MATERIALI / Colors of the materials / Farben der Materialien / Couleurs des matériaux**



Art. 1092 - Private house - Modena, Italy



IT Misure espresse in mm, tolleranza +/- 1-2 mm. L'azienda si riserva la facoltà di apportare variazioni di dati caratteristici, materiali, design, stili, tonalità, senza alcun preavviso.  
EN Measures in mm, tolerance +/- 1/2 mm. The company reserves the right to carry out variations to technical details, materials, design, style, colors with no previous notice.

**DATI TECNICI / TECHNICAL DATA**

1090-368-3012	LED 10W-170-265V-800lm-3000°K-CRI80
1090-369-3012	LED 10W-170-265V-800lm-3000°K-CRI80

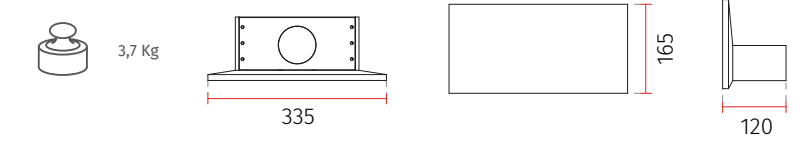

**DATI TECNICI / TECHNICAL DATA**

1091-368-3012	LED 10W-170-265V-800lm-3000°K-CRI80
1091-369-3012	LED 10W-170-265V-800lm-3000°K-CRI80

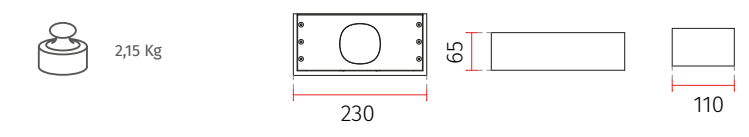

**DATI TECNICI / TECHNICAL DATA**

1092-368-3012	LED 20W-170-265V-1600lm-3000°K-CRI80
1092-369-3012	LED 20W-170-265V-1600lm-3000°K-CRI80

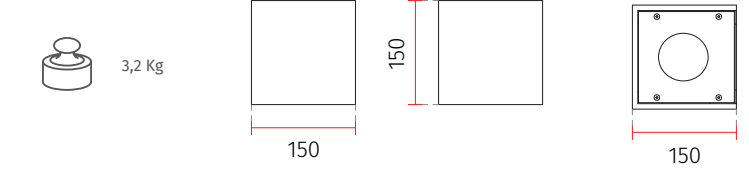

**DATI TECNICI / TECHNICAL DATA**

1094-368-3012	LED 10W-170-265V-800lm-3000°K-CRI80
1094-369-3012	LED 10W-170-265V-800lm-3000°K-CRI80

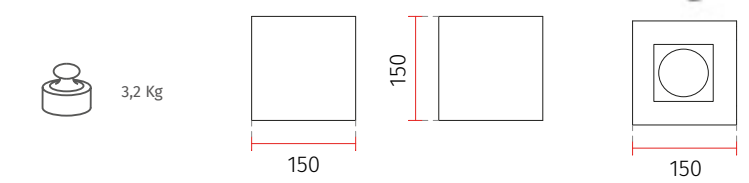
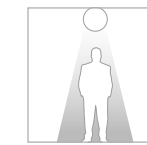

DE Die Masse sind in mm, mit einer Tolleranz von +/- 1-2 mm ausgedrückt, Die Firma behält sich das Recht vor ohne Voranmeldung Änderungen an den Werkstoffen, am Design, am Stil und an der Färbung vorzunehmen.  
FR Mesures en mm, tolérance +/- 1/2 mm. La société se réserve le droit de modifier sans préavis les détails techniques, les matériaux, le design, le style et les couleurs.

**DA ESTERNO**  
Outdoor Lamps  
Aussenleuchten  
Lampes d'extérieur

CONCRETE®

made in Italy

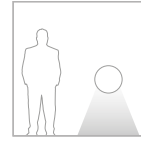

■ **COLORI DEI MATERIALI** / Colors of the materials /  
Farben der Materialien / Couleurs des matériaux



**368**  
CONCRETE®  
Grey



**369**  
CONCRETE®  
Dark grey

**DATI TECNICI / TECHNICAL DATA**

<b>1093-368-3011</b>	LED 10W-170-265V-750lm-3000°K-CRI80
<b>1093-369-3011</b>	LED 10W-170-265V-750lm-3000°K-CRI80

SECTION INDEX  
GENERAL INDEX  
1093



17,7 Kg

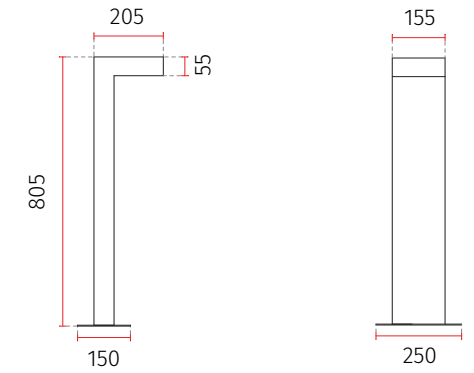

Art. 1093 / 1093B - Private house - Finland



**DATI TECNICI / TECHNICAL DATA**

<b>1093B-368-3011</b>	LED 10W-170-265V-750lm-3000°K-CRI80
<b>1093B-369-3011</b>	LED 10W-170-265V-750lm-3000°K-CRI80

SECTION INDEX  
GENERAL INDEX  
1093B



14,7 Kg

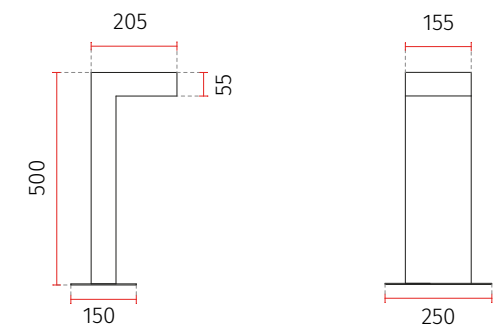

IT Misure espresse in mm, tolleranza +/- 1-2 mm. L'azienda si riserva la facoltà di apportare variazioni di dati caratteristici, materiali, design, stili, tonalità, senza alcun preavviso.  
EN Measures in mm, tolerance +/- 1/2 mm. The company reserves the right to carry out variations to technical details, materials, design, style, colors with no previous notice.

DE Die Masse sind in mm, mit einer Tolleranz von +/- 1-2 mm ausgedrückt, Die Firma behält sich das Recht vor ohne Voranmeldung Änderungen an den Werkstoffen, am Design, am Stil und an der Färbung vorzunehmen.  
FR Mesures en mm, tolérance +/- 1/2 mm. La société se réserve le droit de modifier sans préavis les détails techniques, les matériaux, le design, le style et les couleurs.

# LAMPADINE E STRIP LED

Strip LED and bulbs

LED Bänder und Leuchtmittel

Ruban LED et ampoules



L001 p.396



L004 p.396



L002 p.397



L005 p.397

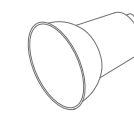

L007 p.397

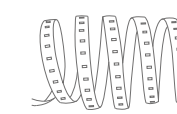

021.790 p.398



021.791 p.398



021.792 p.398



021.793 p.398



021.794 p.398

# LAMPADINE

BULBS  
LEUCHTMITTEL  
AMPOULES



## L001

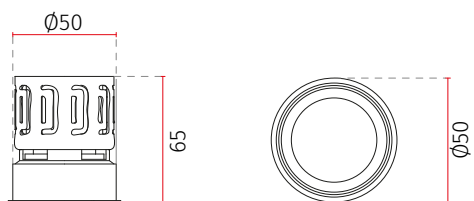

### DATI TECNICI / TECHNICAL DATA

<b>L001-3018</b>	LED 8W-220-240V-650lm-3000°K-CRI85 - 60°
------------------	--

Versione senza alimentatore / Version without power supply / Version ohne Betriebsgerät / Version sans alimentation:

<b>L001-3019</b>	LED 8W-700mA-650lm-3000°K-CRI85 - 60°
026.219	DRIVER DIM PUSH/0-10V/DALI 19.6W 700mA
026.207	DRIVER DIM 0-10V 60.2W 700mA
026.206	DRIVER DIM PUSH/DALI 60.2W 700mA

### ACCESSORI / ACCESSORIES

<b>099.142</b>	Pg.415 Kit emergenza / Emergency Kit
----------------	--------------------------------------

## L004

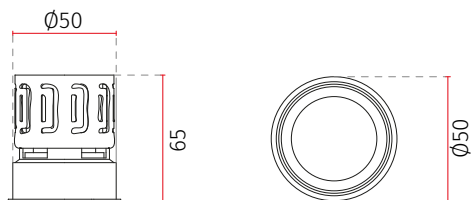

### DATI TECNICI / TECHNICAL DATA

<b>L004-3018</b>	LED 8W-220-240V-650lm-3000°K-CRI85 - 30°
------------------	--

Versione senza alimentatore / Version without power supply / Version ohne Betriebsgerät / Version sans alimentation:

<b>L004-3019</b>	LED 8W-700mA-650lm-3000°K-CRI85 - 30°
026.219	DRIVER DIM PUSH/0-10V/DALI 19.6W 700mA
026.207	DRIVER DIM 0-10V 60.2W 700mA
026.206	DRIVER DIM PUSH/DALI 60.2W 700mA

### ACCESSORI / ACCESSORIES

<b>099.142</b>	Pg.415 Kit emergenza / Emergency Kit
----------------	--------------------------------------

### DATI TECNICI / TECHNICAL DATA

<b>L002-3020</b>	LED 12W-220-240V-1000lm-3000°K-CRI85 - 60°
------------------	--

Versione senza alimentatore / Version without power supply / Version ohne Betriebsgerät / Version sans alimentation:

<b>L002-3021</b>	LED 12W-350mA-1000lm-3000°K-CRI85 - 60°
026.219	DRIVER DIM PUSH/0-10V/DALI 16.1W 350mA
026.187	DRIVER DIM 0-10V 35W 350mA
026.185	DRIVER DIM PUSH/DALI 35W 350mA

### ACCESSORI / ACCESSORIES

<b>099.142</b>	Pg.415 Kit emergenza / Emergency Kit
----------------	--------------------------------------

## L002

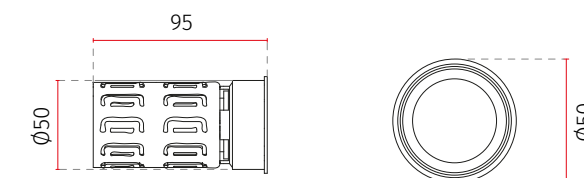

### DATI TECNICI / TECHNICAL DATA

<b>L005-3020</b>	LED 12W-220-240V-1000lm-3000°K-CRI85 - 30°
------------------	--

Versione senza alimentatore / Version without power supply / Version ohne Betriebsgerät / Version sans alimentation:

<b>L005-3021</b>	LED 12W-350mA-1000lm-3000°K-CRI85 - 30°
026.219	DRIVER DIM PUSH/0-10V/DALI 16.1W 350mA
026.187	DRIVER DIM 0-10V 35W 350mA
026.185	DRIVER DIM PUSH/DALI 35W 350mA

### ACCESSORI / ACCESSORIES

<b>099.142</b>	Pg.415 Kit emergenza / Emergency Kit
----------------	--------------------------------------

## L005

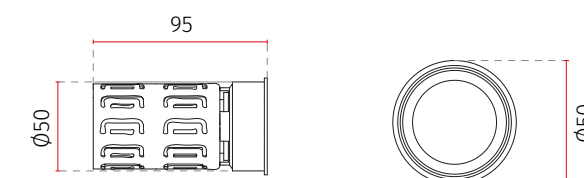

### DATI TECNICI / TECHNICAL DATA

<b>L007</b>	LED GU10 Ø35mm 3.2W-220-240V-220lm-3000°K-CRI85
-------------	---



## L007



IT Misure espresse in mm, tolleranza +/- 1-2 mm. L'azienda si riserva la facoltà di apportare variazioni di dati caratteristici, materiali, design, stili, tonalità, senza alcun preavviso.  
EN Measures in mm, tolerance +/- 1/2 mm. The company reserves the right to carry out variations to technical details, materials, design, style, colors with no previous notice.

DE Die Maße sind in mm, mit einer Tolleranz von +/- 1-2 mm ausgedrückt. Die Firma behält sich das Recht vor ohne Voranmeldung Änderungen an den Werkstoffen, am Design, am Stil und an der Färbung vorzunehmen.  
FR Mesures en mm, tolérance +/- 1/2 mm. La société se réserve le droit de modifier sans préavis les détails techniques, les matériaux, le design, le style et les couleurs.



### 021.790



	Tonalità <i>Color Temp.</i>	Potenza <i>Power</i>	Flusso <i>Light Output</i>	LED	Tensione <i>Tension</i>	LED/m	Larghezza <i>Width</i>	Tagliabile ogni <i>Cuttable</i>	CRI	IP
021.790	3000°K	15W/m	1400lm/m	2835	24Vdc	140	10mm	50mm	>90	IP20
021.790W	2700°K	15W/m	1350lm/m	2835	24Vdc	140	10mm	50mm	>90	IP20
021.790C	4000°K	15W/m	1450lm/m	2835	24Vdc	140	10mm	50mm	>90	IP20

### 021.791



	Tonalità <i>Color Temp.</i>	Potenza <i>Power</i>	Flusso <i>Light Output</i>	LED	Tensione <i>Tension</i>	LED/m	Larghezza <i>Width</i>	Tagliabile ogni <i>Cuttable</i>	CRI	IP
021.791	3000°K	18W/m	2000lm/m	2835	24Vdc	224	10mm	36mm	>90	IP20
021.791W	2700°K	18W/m	1900lm/m	2835	24Vdc	224	10mm	36mm	>90	IP20
021.791C	4000°K	18W/m	2100lm/m	2835	24Vdc	224	10mm	36mm	>90	IP20

### 021.792



	Tonalità <i>Color Temp.</i>	Potenza <i>Power</i>	Flusso <i>Light Output</i>	LED	Tensione <i>Tension</i>	LED/m	Larghezza <i>Width</i>	Tagliabile ogni <i>Cuttable</i>	CRI	IP
021.792	3000°K	26W/m	3000lm/m	2835	24Vdc	224	10mm	36mm	>90	IP20
021.792W	2700°K	26W/m	2850lm/m	2835	24Vdc	224	10mm	36mm	>90	IP20
021.792C	4000°K	26W/m	3150lm/m	2835	24Vdc	224	10mm	36mm	>90	IP20

### 021.793



	Tonalità <i>Color Temp.</i>	Potenza <i>Power</i>	Flusso <i>Light Output</i>	LED	Tensione <i>Tension</i>	LED/m	Larghezza <i>Width</i>	Tagliabile ogni <i>Cuttable</i>	CRI	IP
021.793	3000°K	10W/m	1150lm/m	2835	24Vdc	224	10mm	36mm	>90	IP20
021.793W	2700°K	10W/m	1100lm/m	2835	24Vdc	224	10mm	36mm	>90	IP20
021.793C	4000°K	10W/m	1200lm/m	2835	24Vdc	224	10mm	36mm	>90	IP20

### 021.794



\*strip LED Bianco Dinamico vedi pag. 412 / *Tunable White Strip LED see page 412*  
*Dynamisches Weiss LED Bänder Seite 412 / Rubans LED Blanc Dynamique voir page 412*

	Tonalità <i>Color Temp.</i>	Potenza <i>Power</i>	Flusso <i>Light Output</i>	LED	Tensione <i>Tension</i>	LED/m	Larghezza <i>Width</i>	Tagliabile ogni <i>Cuttable</i>	CRI	IP
021.794	2700°K 6000°K	20W/m	1800lm/m 2000lm/m	2835	24Vdc	160	10mm	50mm	85	IP20

COD.	STANDARD (ON / OFF)				SLIM (P009)				DIMMER (PUSH - DALI - 0/10V - 1/10V)				
	026.258	026.259	026.260	026.261	026.262	026.267A	026.267	026.268	026.269	026.219	026.209	026.190 +	026.190 +
P [W]	12W	36W	60W	150W	240W	30W	60W	100W	150W	21,6W	60W	150W	240W
OUT	24Vdc	24Vdc	24Vdc	24Vdc	24Vdc	24Vdc	24Vdc	24Vdc	24Vdc	24Vdc	24Vdc	24Vdc	24Vdc
CORRENTE <i>Current</i>	500mA	1500mA	2500mA	6250mA	10000mA	1250mA	2500mA	4160mA	6250mA	900mA	2500mA	6250mA	10000mA

#### STRIP LED COLLEGABILI CONNECTABLE LED STRIPS

Codice <i>Code</i>	Potenza <i>Power</i>	L <i>[cm]</i>	021.790		021.791		021.792		021.793		021.794				
			1	2	1	2	1	2	1	2	1	2			
021.790.050	7.5W	50	1	1-4	1	1-4	1	1-4	1	1-4	1	1-4			
021.790.100	15W	100		1-2		1-2		1-2		1-2		1-2			
021.790.150	22.5W	150		1		1		1		1		1			
021.790.200	30W	200		1		1		1		1		1			
021.790.300	45W	300				1		1		1		1			
021.790.500	75W	500				1		1		1		1			
021.791.050	9W	50	1	1-4	1	1-4	1	1-4	1	1-4	1	1-4			
021.791.100	18W	100		1-2		1-2		1-2		1-2		1-2			
021.791.150	27W	150		1		1		1		1		1			
021.791.200	36W	200				1		1		1		1			
021.791.300	54W	300				1		1		1		1			
021.791.500	90W	500				1		1		1		1			
021.792.050	13W	50		1-2		1-2		1-2		1-2		1-2			
021.792.100	26W	100		1		1		1		1		1			
021.792.150	39W	150				1		1		1		1			
021.792.200	52W	200				1		1		1		1			
021.792.300	78W	300				1		1		1		1			
021.792.500	130W	500				1		1		1		1			
021.793.050	5W	50	1-2	1-6	1-12	1-30	1-48	1-5	1-12	1-20	1-30	1-4	1-12	1-30	1-48
021.793.100	10W	100	1	1-3	1-6	1-15	1-24	1-3	1-6	1-10	1-15	1-2	1-6	1-15	1-24
021.793.150	15W	150		1-2	1-4	1-10	1-16	1-2	1-4	1-6	1-10	1	1-4	1-10	1-16
021.793.200	20W	200		1	1-3	1-7	1-12	1	1-3	1-5	1-7	1	1-3	1-7	1-12
021.793.300	30W	300		1	1-2	1-5	1-8	1	1-2	1-3	1-5		1-2	1-5	1-8
021.793.500	50W	500			1	1-3	1-4		1	1-2	1-3		1	1-3	1-4



# PARTI ELETTRICHE

Electrical parts  
Elektrische Teile  
Parties electriques

KIT LED	ALIMENTATORI <i>Power supplies</i>	CASAMBI	BIANCO DINAMICO <i>Tunable White</i>	KIT EMERGENZA <i>Emergency kit</i>
p.402	p.404	p.410	p.414	p.416

Il KIT LED è stato pensato per essere installato nella maggior parte degli articoli della nostra collezione; è proposto in varie lunghezze/ potenze per essere utilizzato in diverse misure di applique. I LED sono distribuiti omogeneamente nella larghezza del prodotto così da evitare una luce eccessiva e abbagliante in un solo punto e creare un effetto più gradevole all'occhio.

EN The new LED kit has been designed to work with almost all of the products in the collection; it is proposed in a number of sizes/power options so it can be used on different length wall brackets. The LEDs are distributed evenly across the width of the products to avoid having a strong single point of illumination and therefore any glare and to create a pleasant visual impact.

DE Das neue KIT LED ist für die Beleuchtung der meisten Artikel unserer Kollektion geeignet. Es wird in verschiedenen Längen und Leistungen angeboten, um für unterschiedliche Größen von Wandlampen verwendet werden zu können. Die LEDs sind gleichmäßig über die Breite des Produkts verteilt, damit ein blendendes bzw. übermäßiges Licht an einzelnen Stellen ausgeschlossen werden kann und ein angenehmer Effekt für das Auge gewährleistet ist.

FR Le KIT LED a été conçu pour être installé dans la plupart des articles de notre collection, il est disponible en différentes longueurs/puissances pour être utilisé dans différentes dimensions d'applique. Les LED sont réparties de manière homogène sur la largeur du produit, de manière à éviter une lumière excessive et éblouissante à un seul endroit, ce qui permet de créer un effet plus agréable pour l'œil.

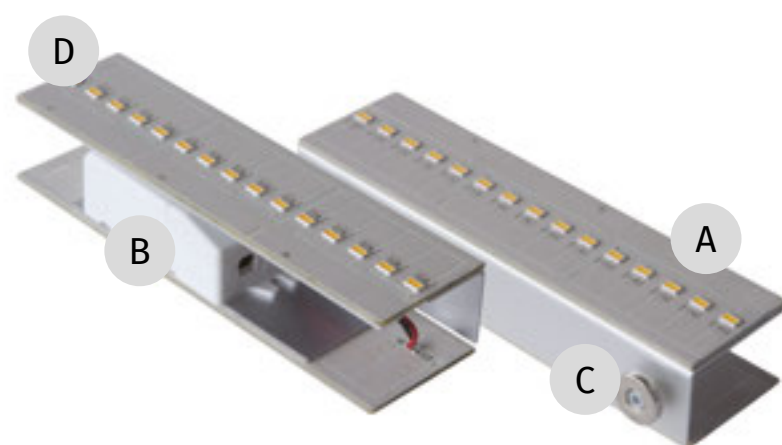

**A Protezione silconica**

**B Alimentatore**  
Collegato e installato all'interno dell'applique

**C Aggancio magnetico**  
Grazie all'aggancio magnetico il prodotto risulta estremamente facile e rapido da installare o da rimuovere in caso di manutenzione

**D Diodi LED**  
I diodi sono rivestiti da una vernice extra trasparente che li protegge dalla polvere e ne permette la pulizia.

EN

**A Silicon coating**  
**B Power supply**  
Connected and installed inside the wall lamp.

**C Magnetic connection system**  
Thanks to the magnetic connection system the product is easy and quick to install or remove for maintenance.

**D Led diodes**  
The diodes are protected by an ultraclear coating that keeps them dust free and allows easy cleaning.

DE

**A Silikonbeschichtung**  
**B Betriebsgerät**  
In der Wandleuchte installiert und angeschlossen

**C Magnethaken**  
Dank des Magnethakens kann das Produkt extrem schnell und einfach installiert bzw. zur Wartung und Reparatur abgenommen werden.

**D Led-dioden**  
Die Dioden sind mit einer extra-klaren Lackierung beschichtet, die sie vor Staub schützt und eine einfache Reinigung ermöglicht.

FR

**A Protection silconique**  
**B Alimentation**  
Connecté et installé à l'intérieur de l'applique.

**C Système de connexion magnétique**  
Grâce au couplage magnétique, le produit est extrêmement facile et rapide à installer ou à enlever en cas de maintenance

**D Diodes de led**  
Les diodes sont protégées par un revêtement ultra-transparent qui les protège de la poussière et facilite le nettoyage.

Parte elettrica Electrical part	Per articolo For article	Codice per l'ordine Codes for the order	Caratteristiche tecniche Technical Characteristics
3051	7310	099.500	LED 9W-220-240V-1350lm-3000°K-CRI85
3052	2139 - 7156 - 7157 - 7576 - 8429	099.501	LED 12W-220-240V-1800lm-3000°K-CRI85
3053	7577 - 8428	099.502	LED 15W-220-240V-2250lm-3000°K-CRI85
3054	2456 - 2458 - 8430	099.503	LED 18W-220-240V-2700lm-3000°K-CRI85
3055	7578 - 8431	099.504	LED 24W-220-240V-3600lm-3000°K-CRI85
3056	2013 - 2601A	099.505	LED 6W-220-240V-900lm-3000°K-CRI85
3057	2012 - 2018 - 2340 - 2388 - 2457 - 2603A - 2603B - 2604B - 8215 - 8216 - 9207	099.506	LED 9W-220-240V-1350lm-3000°K-CRI85
3058	2293 - 8342	099.507	LED 12W-220-240V-1800lm-3000°K-CRI85
3059	7646 - 8254 - 8259	099.508	LED 15W-220-240V-2250lm-3000°K-CRI85
3060	2014 - 2019 - 2608B	099.509	LED 18W-220-240V-2700lm-3000°K-CRI85
3061	2020 - 8760	099.510	LED 24W-220-240V-3600lm-3000°K-CRI85
3063	2569 - 2570	099.511	LED 9W-220-240V-1350lm-3000°K-CRI85
3064	2304	099.512	LED 12W-220-240V-1800lm-3000°K-CRI85
3064	7305 - 7958	099.513	LED 12W-220-240V-1800lm-3000°K-CRI85
3065	8285	099.514	LED 15W-220-240V-2250lm-3000°K-CRI85
3065	8336	099.515	LED 15W-220-240V-2250lm-3000°K-CRI85
3066	8337	099.517	LED 18W-220-240V-2700lm-3000°K-CRI85
3067	8338	099.518	LED 24W-220-240V-3600lm-3000°K-CRI85
3069	8459	099.521	LED 9W-220-240V-1350lm-3000°K-CRI85
3070	8056	099.522	LED 12W-220-240V-1800lm-3000°K-CRI85
3071	8042 - 8144	099.524	LED 15W-220-240V-2250lm-3000°K-CRI85
3071	8284 - 8382	099.525	LED 15W-220-240V-2250lm-3000°K-CRI85
3072	2455	099.526	LED 18W-220-240V-2700lm-3000°K-CRI85
3072	8759	099.527	LED 18W-220-240V-2700lm-3000°K-CRI85
3076	8235	099.531	LED 13.5W-220-240V-2000lm-3000°K-CRI85
3078	8411 - 8481	099.532	LED 19.5W-220-240V-2900lm-3000°K-CRI85

# ALIMENTAZIONE A CORRENTE COSTANTE

Constant current power supply / Konstantstrombetriebsgerät / Alimentation en courant constant

C.C.  
[mA.]

I prodotti con l'indicazione <sup>C.C.</sup> [mA.] necessitano di un alimentatore con uscita in corrente costante. Il collegamento di più articoli funzionanti in corrente costante deve essere effettuato in serie poiché ogni apparecchio deve essere attraversato dalla medesima corrente [mA].

EN Products marked with <sup>C.C.</sup> [mA.] require a constant current output power supply. Appliances powered at constant current must be connected together in series as each appliance must be powered at the same current [mA].

DE Die Produkte mit der Kennzeichnung <sup>C.C.</sup> [mA.] benötigen ein Betriebsgerät mit Konstantstromausgang. Der Anschluss von mehreren, mit Konstantstrom betriebenen Artikeln muss in Reihe geschaltet erfolgen, weil jedes einzelne Gerät vom gleichen Strom [mA] gespeist werden muss.

FR Les produits portant l'indication <sup>C.C.</sup> [mA.] nécessitent une alimentation avec sortie à courant constant. La connexion de plusieurs articles fonctionnant en courant constant doit être effectuée en série puisque chaque appareil doit être traversé par le même courant [mA].

## Scelta dell'alimentatore

1. L'uscita dell'alimentatore deve essere a corrente costante (costant current). La corrente [mA] in uscita deve essere uguale a quella nominale dell'articolo da pilotare.
2. La somma delle Potenze [W] dei faretto da alimentare non deve superare la potenza di targa dell'alimentatore

### EN Choosing the power supply

1. The power supply output must be at constant current. The output current [mA] must be equal to the rated output current of the powered appliance.
2. The sum of the power outputs [W] of the spotlights to power must not exceed the rated power output of the power supply.

### DE Wahl des Betriebsgeräts

1. Der Ausgang des Betriebsgeräts muss mit Konstantstrom (constant current) sein. Der Ausgangsstrom [mA] muss gleich als der Nennstrom des zu steuernden Artikels sein.
2. Die Summe der Leistungen [W] der zu speisenden Spots darf die Nennleistung des Betriebsgeräts nicht überschreiten.

### FR Choix de l'alimentation

1. L'alimentation doit avoir une sortie à courant constant (constant current). Le courant [mA] de sortie doit être égal au courant nominal de l'article devant être piloté.
2. La somme des puissances [W] des spots qui doivent être alimentés ne doit pas dépasser la puissance indiquée sur la plaquette de l'alimentation.

Esempio di collegamento di più articoli alimentati in corrente costante / Example of connecting appliances powered at constant current / Anschlussbeispiel von mehreren, mit Konstantstrom versorgten Artikeln / Exemple de connexion de plusieurs articles alimentés en courant constant

### Collegamento in serie

Connection in series / Reihenschaltung / Connexion en série

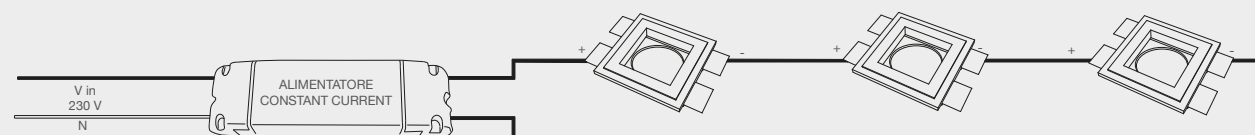

# ALIMENTAZIONE A TENSIONE COSTANTE

Constant voltage power supply / Ledsysteme mit Konstantspannungsbetriebsgerät / Alimentation à tension constante

C.V.  
[V]

I prodotti con l'indicazione <sup>C.V.</sup> [V] necessitano di un alimentatore con uscita in tensione costante. Il collegamento di più articoli funzionanti in tensione costante deve essere effettuato in parallelo poiché ogni apparecchio deve essere alimentato allo stesso voltaggio [V]. Tutti gli articoli della collezione 9010 che necessitano di un'alimentazione in tensione costante di 24Vdc sono dotati di circuito LED personalizzato 9010 .

EN Products marked with <sup>C.V.</sup> [V] require a constant voltage output power supply. Appliances powered at constant voltage must be connected together in parallel as each appliance must be powered at the same voltage [V]. All the items in the 9010 collection that require a 24 Vdc constant voltage power supply are fitted with the customised 9010 LED circuit.

DE Die Produkte mit der Kennzeichnung <sup>C.V.</sup> [V] benötigen ein Betriebsgerät mit einem Konstantspannungsausgang. Der Anschluss von mehreren mit Konstantspannung betriebenen Artikeln muss parallel erfolgen, weil alle Geräte mit dem gleichen Spannung [V] gespeist werden müssen. Alle Artikel der Kollektion 9010, die ein 24Vdc-Konstantspannungsbetriebsgerät benötigen, sind mit dem personalisierten 9010-LED-Kreis ausgestattet.

FR Les produits portant l'indication <sup>C.V.</sup> [V] nécessitent une alimentation avec sortie à tension constante. La connexion de plusieurs articles fonctionnant en tension constante doit être effectuée en parallèle puisque chaque appareil doit être alimenté avec le même voltage [V]. Tous les articles de la collection 9010 qui nécessitent une alimentation avec une tension constante de 24 Vdc sont dotés du circuit LED personnalisé 9010.

## Scelta dell'alimentatore

1. L'uscita dell'alimentatore deve essere a tensione costante (costant voltage) e la tensione in uscita [V] deve essere uguale a quella nominale dell'articolo da pilotare.
2. La somma delle potenze [W] dei faretto da alimentare non deve superare la potenza di targa dell'alimentatore

### EN Choosing the power supply

1. The power supply output must be at constant voltage and the output voltage [V] must be equal to the rated output voltage of the powered appliance.
2. The sum of the power outputs [W] of the spotlights to power must not exceed the rated power output of the power supply.

### DE Wahl des Betriebsgeräts

1. Der Ausgang des Betriebsgeräts muss mit Konstantspannung (constant voltage) sein. Die Ausgangsspannung [V] muss der Nennspannung des zu steuernden Artikels entsprechen.
2. Die Summe der Leistungen [W] der zu speisenden Spots darf die Nennleistung des Betriebsgeräts nicht überschreiten.

### FR Choix de l'alimentation

1. L'alimentation doit avoir une sortie à tension constante (constant voltage) et la tension de sortie [V] doit être égale à la tension nominale de l'article devant être piloté ;
2. La somme des puissances [W] des spots qui doivent être alimentés ne doit pas dépasser la puissance indiquée sur la plaquette de l'alimentation.

Esempio di collegamento di più articoli alimentati in Tensione costante / Example of connecting appliances powered at constant voltage / Anschlussbeispiel von mehreren, mit Konstantspannung versorgten Artikeln / Exemple de connexion de plusieurs articles alimentés en tension constant

### Collegamento in parallelo

Connection in parallel / Parallelschaltung / Connexion en parallèle

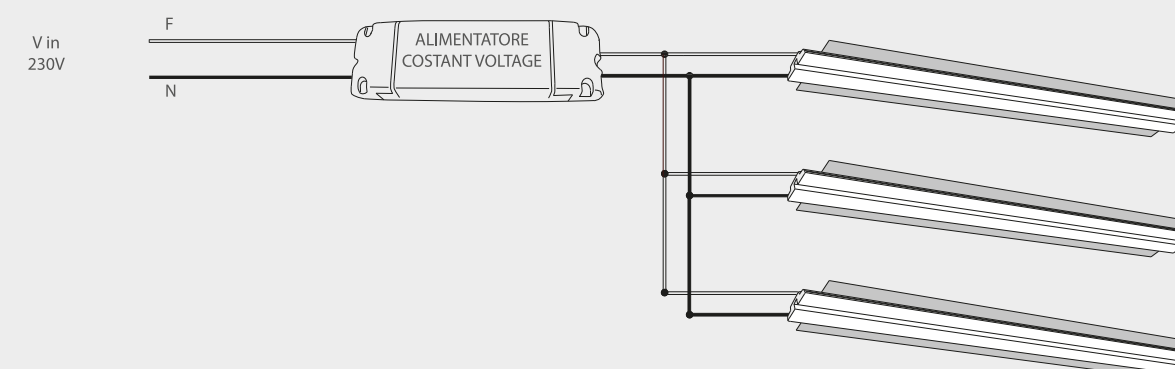

# TIPOLOGIE DI CONTROLLO DELL'ILLUMINAZIONE

Types of light control systems / Steuermöglichkeiten der Beleuchtung /  
Types de contrôle de l'éclairage

# ALIMENTATORI DIMMERABILI

Dimmable power supplies / Dimmbare Betriebsgeräte / Alimentations dimmables

C.C.  
[m.A.]

## Alimentatore dimmerabile tramite pulsante

La pressione sul pulsante comanda l'accensione del prodotto e ne regola l'intensità luminosa:

- Pressione breve del pulsante (accensione / spegnimento)
- Pressione prolungata del pulsante (variazione dell'intensità luminosa).

Può essere collegato all'alimentatore qualsiasi pulsante di comando con contatto normalmente aperto. N.B. Il pulsante non è fornito con l'alimentatore.

### EN Power supply with dimmer-regulating button

Press the button to switch on the appliance and adjust its light intensity:  
· Press and release the button (switch on / off) · Press and hold down the button (change light intensity). Any control button with a normally open contact can be connected to the power supply. N.B. The button is not supplied with the power supply.

### DE Mittels Taste dimmbares Betriebsgerät

Durch Drücken der Taste wird das Gerät eingeschaltet und die Leuchtstärke geregelt: · kurzes Drücken der Taste (Einschalten / Ausschalten) · langes Drücken der Taste (Variieren der Lichtstärke) Hinweis: Die Taste wird nicht mit dem Betriebsgerät geliefert. An das Betriebsgerät kann jede beliebige Steuertaste mit Schließer angeschlossen werden. N.B. Die Taste ist nicht im Lieferumfang enthalten.

### FR Alimentation dimmable avec bouton poussoir

La pression du bouton commande l'allumage du produit et règle l'intensité lumineuse : · Pression brève sur le bouton (allumage/extinction) · Pression prolongée sur le bouton (variation de l'intensité lumineuse). Tous les boutons de commande avec contact normalement ouvert peuvent être reliés à l'alimentation. N.B. Le bouton n'est pas fourni avec l'alimentation.

## Alimentatore dimmerabile tramite segnale analogico 0-10 V

Questa tipologia di comando consiste nell'applicare all'alimentatore un segnale analogico che può variare dai 0V (illuminazione al minimo) ai 10V (illuminazione massima).

### EN Power supply with dimmer-regulating 0-10 V analogue signal

This control typology involves applying an analogue signal to the power supply which can range from 0V (minimum lighting) to 10 V (maximum lighting).

### DE Mittels 0-10V – Analogsignal dimmbares Betriebsgerät

Bei dieser Steuerart wird das Betriebsgerät mittels eines Analogsignals gesteuert, das von 0V (Mindestbeleuchtung) bis zu 10V (maximale Beleuchtung) variieren kann.

### FR Alimentation dimmable avec signal analogique 0-10 V

Ce type de commande consiste à appliquer à l'alimentation un signal analogique qui peut aller de 0V (éclairage minimum) à 10 V (éclairage maximum).

## Alimentatore dimmerabile tramite sistema DALI

L'alimentatore può essere pilotato attraverso un'unità di controllo compatibile con lo standard DALI.

### EN Power supply with dimmer-regulating DALI system

The power supply can be powered via a DALI-compatible control unit.

### DE Mittels DALI-System Dimmbares Betriebsgerät

Das Betriebsgerät kann mittels einer mit dem DALI-Standard kompatiblen Steuereinheit gesteuert werden.

### FR Alimentation dimmable avec système DALI

L'alimentation peut être commandée à travers une unité de commande compatible avec le protocole DALI.

## Alimentatore dimmerabile a taglio di fase

Tecnologia di dimmerazione già diffusa per le lampade tradizionali a tensione di rete (vecchie incandescenza o alogene).

L'intensità della luce del LED può essere variata agendo direttamente sul primario dell'alimentatore tramite l'utilizzo di un dispositivo di comando esterno (non fornito con la lampada) con uscita a fase tagliata.

### EN Phase cutting dimmable power supply

Dimming technology already diffused for traditional mains voltage lamps (old incandescent or halogen bulbs).  
The intensity of the LED light can be varied by acting directly on the primary power supply using an external control device (not supplied with the lamp) with a cut phase output.

### DE Dimmbares netzgerät mit phasenabschnitt

Für herkömmliche Lampen mit Netzspannung (Glüh- und Halogenlampen) bereits verwendete Dimmtechnik.

Die Lichtintensität der LED kann durch direktes Einwirken auf den Primärkreis des Netzgeräts unter Verwendung eines externen Steuergeräts (nicht mit der Lampe geliefert) mit Phasenabschnitt am Ausgang geändert werden.

### FR Alimentation dimmable à coupure de phase

Technologie de variation déjà répandue pour les lampes traditionnelles à tension de réseau (vieilles ampoules à incandescence ou halogènes).  
Il est possible de varier l'intensité de la lumière de la LED directement à travers le primaire de l'alimentation à l'aide d'un dispositif de commande extérieur (non fourni avec la lampe) avec sortie à phase coupée.

## Dimmerazione su articoli LED controllati in corrente costante

9010 mette a disposizione una vasta gamma di alimentatori dimmerabili con uscita in Corrente Costante. Per le tre tipologie di controllo (Push, 0-10V e DALI) ci sono diverse opzioni per taglie di potenza e corrente diverse, come indicato nella tabella di ogni articolo.

### EN Dimmer-regulated LED appliances with constant current control

9010 features an extensive range of dimmer-regulated power supplies with Constant Current output. Different options with different power and current outputs are available for all three control typologies (Push, 0-10 V and DALI), as indicated in the details of each article page.

### DE Dimmen von LEDgeräten mit Konstantstromversorgung

9010 novantadici bietet eine große Auswahl von dimmbaren Betriebsgeräten mit Konstantstromausgang. Für die drei vorgenannten Steuerarten (Push, 0-10V und DALI) stehen diverse Optionen mit unterschiedlichen Leistungen und Stromstärken zur Verfügung, wie in den Details jeder Artikelseite angegeben.

### FR Dimmeration sur articles LED contrôlés en courant constant

9010 propose une vaste gamme d'alimentations dimmables avec sortie en courant constant. Pour les trois types de contrôle (Push, 0-10V et DALI), il existe plusieurs options différentes de puissance et de courant, comme indiqué dans le tableau de chaque article.

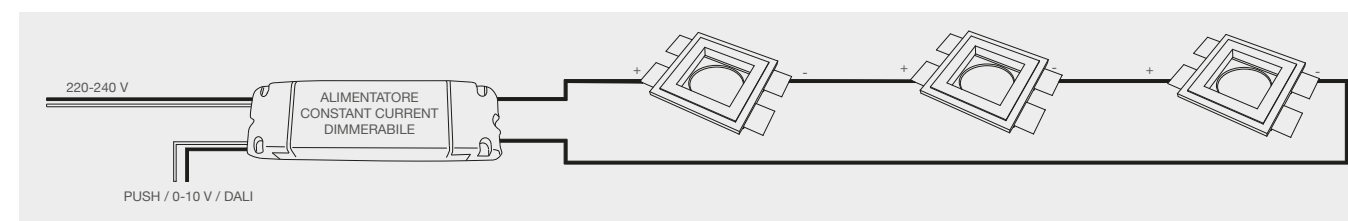

# ALIMENTATORI DIMMERABILI

Dimmable power supplies / Dimmbare Betriebsgeräte / Alimentations dimmables



C.V.  
[V]

**Dimmerazione su articoli LED controllati in tensione costante**  
9010 offre due possibilità per la dimmerazione di LED comandati in tensione costante:

EN Dimmer-regulated LED appliances with constant voltage control  
9010 offers two possibilities of dimming LEDs with constant voltage control:

## 1. TRAMITE ALIMENTATORE DIMMERABILE:

Questa soluzione è ideale per sistemi di bassa potenza (fino a max 25W totali), per alimentare il dispositivo LED si usa direttamente un alimentatore provvisto della parte di comando per la dimmerazione.

EN 1. WITH DIMMER-REGULATED POWER SUPPLY: This solution is ideal for low power systems (up to a total of 25 W); a power supply fitted with a dimmer control feature is used to directly power the LED device.

DE Ledsysteme mit Konstanzspannungsbetriebsgerät  
9010 novantadici bietet zwei Möglichkeiten zum Dimmen von mit Konstanzspannung gesteuerten LEDs:

FR Variation sur articles LED contrôlés en tension constante  
9010 offre deux possibilités pour la variation de LED commandées en tension constante:

DE 1. MITTELS DIMMBAREM BETRIEBSGERÄT: Diese Lösung ist ideal für Niedrigleistungssysteme (bis max. 25W insgesamt). Um das LEDGerät zu speisen, verwendet man direkt ein Betriebsgerät, das mit einem Steuerelement zur Dimmung ausgestattet ist.

FR 1. AVEC ALIMENTATION DIMMABLE : Cette solution est idéale pour les systèmes à basse puissance (jusqu'à 25 W max. au total), pour alimenter le dispositif LED on utilise directement une alimentation dotée de la partie de commande pour la variation.

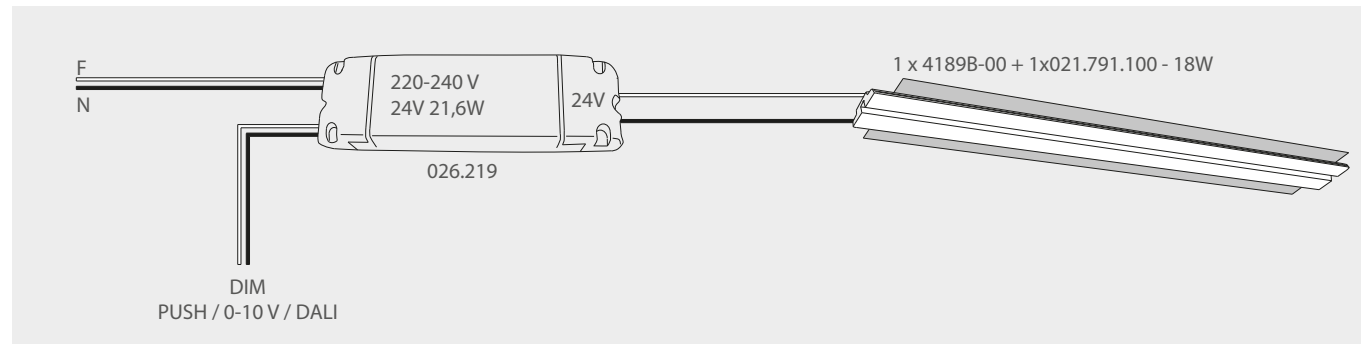

## 2. TRAMITE DRIVER DIMMERABILE:

Questa soluzione è ideale per sistemi di potenza elevata, per controllare il dispositivo si interpone tra l'uscita dell'alimentatore ed il LED un driver che prevede l'ingresso del segnale per poter dimmerare il LED.

EN 2. WITH DIMMER-REGULATED DRIVER: This solution is ideal for high power systems; to control the device, a driver with signal input used to dim the LED is inserted between the power supply output and the LED.

DE 2. MITTELS DIMMBAREM TREIBER: Diese Lösung ist ideal für Systeme mit hoher Leistung. Zur Steuerung des Geräts wird zwischen dem Ausgang des Betriebsgeräts und dem LED ein Treiber mit Signaleingang gesetzt, um die LED dimmen zu können.

FR 2. AVEC DRIVER DIMMABLE : Cette solution est idéale pour les systèmes à puissance élevée, pour contrôler le dispositif on place entre la sortie de l'alimentation et la LED un driver qui prévoit l'entrée du signal pour pouvoir varier la LED.

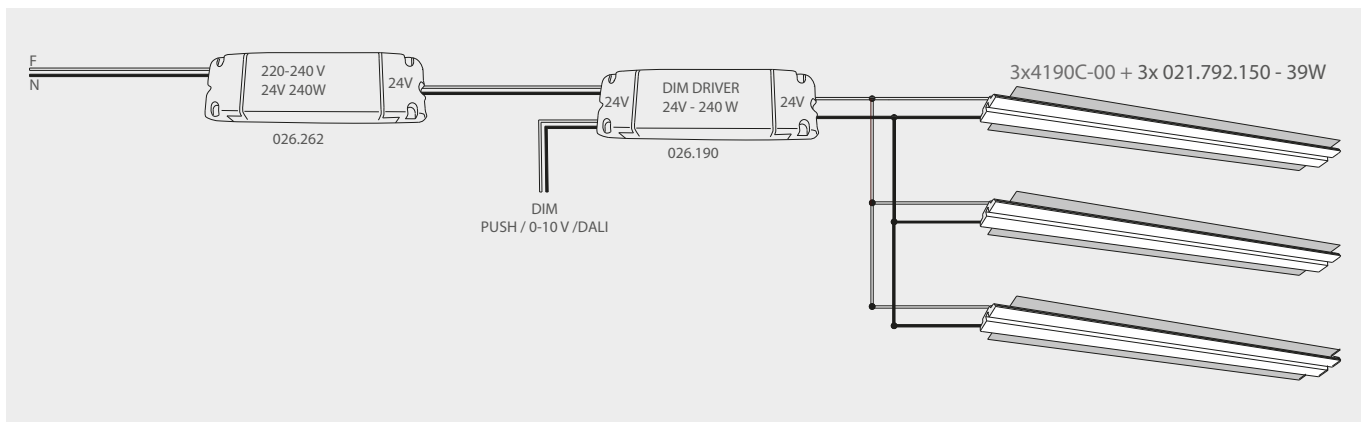

CARATTERISTICHE TECNICHE ALIMENTATORI / TECHNICAL CHARACTERISTICS POWER SUPPLIES / TECHNISCHE EIGENSCHAFTEN BETRIEBSGERÄTE / CARACTÉRISTIQUES TECHNIQUES ALIMENTATIONS

Codice Code	Misure mm Measurements mm			Ingresso [V] Input	TIPO Type	DIM	Potenza Power	min	max	PFC	fdp	Rendim. %
	A	B	H									
026.173	125	38	23	220-240 V-	CC - 700mA		19.6W	10V	28V	att	0,95	0
026.185	124	82	23	180-295V-	CC - 350mA	PUSH/DALI	35W	2V	100V	att	0,975	91
026.187	124	82	23	180-295V-	CC - 350mA	0-10V	35W	2V	100V	att	0,975	91
026.190	156	52	24	12-24Vdc	CV - 24V	PUSH/0-10V/DALI	288W	1mA	12000mA			
026.205	128	60	31,5	180-295 V-	CC - 1050mA		59.9W	34V	57V	att	0,9	87
					CC - 500mA		45W	2V	90V	att	0,975	91,5
					CC - 700mA	PUSH/DALI	60.2W	2V	86V	att	0,975	91,5
					CC - 1400mA		59.9W	2V	57V	att	0,975	91,5
026.206	124	82	23	180-295V-	CC - 900mA		60.3W	2V	67V	att	0,975	91,5
					CC - 500mA		45W	2V	90V	att	0,975	91,5
					CC - 700mA		60.2W	2V	86V	att	0,975	91,5
					CC - 1050mA	PUSH/DALI	59.9W	2V	57V	att	0,975	91,5
026.207	124	82	23	180-295V-	CC - 1400mA	0-10V	58.8W	2V	42V	att	0,975	91,5
					CC - 500mA		45W	2V	90V	att	0,975	91,5
					CC - 700mA		60.2W	2V	86V	att	0,975	91,5
					CC - 900mA		59.9W	2V	57V	att	0,975	91,5
026.209	125	82	29	220-240 V-	CV - 24V	PUSH/1-10V	60.3W	2V	67V	att	0,975	91,5
					CV - 24V		60W	1mA	2500mA	att	0,9	90
					CC - 1400mA		60.2W	25V	43V	att	0,9	87
					CC - 200mA		8W	3V	40V	no	0,5	0
026.212	75	38	22	220-240 V-	CC - 200mA		9.2W	3V	46V	att	0,95	90
					CC - 350mA		16.1W	3V	46V	att	0,95	90
					CC - 500mA	PUSH/0-10V/DALI	20W	3V	40V	att	0,95	90
					CC - 700mA		19.6W	3V	28V	att	0,95	90
026.218	155	51	26	220-240V-	CV - 24V		21.6W	0mA	900mA	att	0,95	90
					CC - 900mA		19.8W	3V	22V	att	0,95	90
					CC - 200mA		9.2W	3V	46V	att	0,95	90
					CC - 350mA		16.1W	3V	46V	att	0,95	90
026.219	84	57	30	90-264 V-	CC - 500mA		19.6W	3V	40V	att	0,95	90
					CC - 700mA		21.6W	0mA	900mA	att	0,95	90
					CC - 900mA		19.8W	3V	22V	att	0,95	90
					CC - 1050mA		34.7W	11V	33V	no	0,6	84
026.220	84	57	30	90-264 V-	CC - 1050mA		34.7W	11V	33V	no	0,6	84
026.221	84	57	30	90-264 V-	CC - 350mA		35W	28V	100V	no	0,6	84
026.236	88,5	41	23	220-240V-	CC - 350mA		12W	25V	34.3V	att	≥0,92	87
026.237	88,5	41	23	220-240V-	CC - 500mA		18W	22V	36V	att	≥0,92	88
026.238	88,5	41	23	220-240V-	CC - 500mA		9W	11V	18V	att	≥0,92	85
026.239	118	42,5	24	220-240V-	CC - 700mA		24.5W	25V	35V	att	>0,95	88
026.240	88,5	41	23	220-240V-	CC - 900mA		13.5W	10V	15V	att	>0,95	88
026.246	118	42,5	24	220-240V-	CC - 900mA		24.3W	19V	27V	att	≥0,92	87
026.250	80	32	25	220-240V-	CC - 350mA		4.2W	8V	12V	att	>0,5	72
026.251	88,5	41	23	220-240V-	CC - 350mA		8.8W	17V	25V	att	≥0,92	85
026.252	88,5	41	23	220-240V-	CC - 350mA		18.2W	36V	52V	att	≥0,92	87
026.254	118	42,5	24	220-240V-	CC - 500mA		23.5W	33V	47V	att	>0,95	88
026.255	88,5	41	23	220-240V-	CC - 700mA		18.2W	17V	26V	att	≥0,92	87
026.256	118	42,5	24	220-240V-	CC - 700mA		35.7W	35.6V	51V	att	>0,95	89
026.257	118	42,5	24	220-240V-	CC - 900mA		36W	30V	40V	att	≥0,95	89
026.258	130	42	23	220-240V-	CV - 24V		12W	0mA	500mA	att	>0,8	81
026.259	167	45	30	220-240V-	CV - 24V		36W	0mA	1500mA	att	>0,87	84
026.260	157	54	36	220-240V-	CV - 24V		60W	0mA	2500mA	att	>0,92	88
026.261	219	63	35,5	180-295V-	CV - 24V		150W	0mA	6250mA	att	≥0,95	89
026.262	244	71	35,5	180-295V-	CV - 24V		240W	0mA	10000mA	att	≥0,95	92
026.267	304,6	30	16,7	220-240V-	CV - 24V		60W	0mA	2500mA	att	≥0,9	88
026.267A	250	30	16,7	220-240V-	CV - 24V		30W	0mA	1250mA	att	≥0,9	88
026.268	312	27	18	220-240V-	CV - 24V		100.1W	0mA	4170mA	att	≥0,9	88
026.269	322.6	30,1	21,5	220-240V-	CV - 24V		150W	0mA	6250mA	att	≥0,9	88
026.277	146,5	44	30	220-240V-	CC - 350mA		18.9W	3V	54V	att	0,95	90
					CC - 500mA		27W	3V	54V	att	0,95	90
					CC - 700mA	CASAMBI/PUSH	35.7W	3V	51V	att	0,95	90
					CC - 900mA		37.8W	3V	42V	att	0,95	90
026.278	87.2	53.4	25	12-24Vdc-	CC - 1050mA		37.8W	3V	36V	att	0,95	90
					CV-TW - 24V		120W	0mA	5000mA			
					CV-RGB - 24V	CASAMBI/PUSH	120W	0mA	5000mA			
026.287	215	70	31	220-240V-	CV-RGBW - 24V		120W	0mA	5000mA			
					CC-TW - 350V		17.5W	20V	50V	att	0,96	87
					CC-TW - 500V	CASAMBI	25W	20V	50V	att	0,96	87
026.288	195	43	30,2	220-240V-	CC-TW - 700V		35W	20V	50V	att	0,96	87
					CC-TW - 900V		38W	20V	42.2V	att	0,96	87
					CC-TW - 1050V		38W	20V	36.2V	att	0,96	87
026.289	45	55	20	12-24Vdc	CV - 24V	CASAMBI	34.9W	0mA	1453mA	att	0,98	89
					CV - 24V	CASAMBI/PUSH	240W	0mA	10000mA			

9010 propone una serie di alimentatori compatibili con la collaudata applicazione CASAMBI che permette di gestire in maniera intuitiva gli apparecchi luminosi.

La gestione tramite smartphone, tablet, altri dispositivi può avvenire in modo rapido:

- Personalizzando SCENARI di luce
- Selezionando il controllo da GALLERIA
- Controllando le singole LAMPADE da foto

Il controllo può avvenire anche tramite display o pulsante di controllo delle luci.

EN 9010 proposes a series of power supplies that are compatible with the tested CASAMBI application that allows you to intuitively manage the lighting fixtures. The power supplies can be quickly managed using smartphones, tablets, other devices:

- You can customise your light SCENARIOS
- You can select the control from the GALLERY
- You can control the individual LAMPS from an image

It can also be controlled using a display or light control button.

DE 9010 umfasst eine Reihe von Netzgeräten, die mit der bewährten CASAMBI-Applikation für die intuitive Steuerung der Leuchtmittel kompatibel sind. Schnelle Steuerung per Smartphone, Tablet und anderen Geräten unter:

- Personalisierung der LICHTSZENARIEN
- Auswahl der Steuerung über GALERIE
- Steuerung der einzelnen LEUCHTEN über Foto

Die Steuerung kann auch mittels Display oder Steuertaster der Leuchten erfolgen.

FR 9010 propose une série d'alimentations compatibles avec l'application CASAMBI, qui permet de gérer de manière intuitive les appareils lumineux. La gestion par smartphone, tablette ou d'autres appareils peut être effectuée rapidement :

- En personnalisant des SCÉNARIOS de lumière
- En sélectionnant le contrôle depuis la GALERIE
- En contrôlant chaque LAMPE depuis une photo

Le contrôle peut également être réalisé depuis l'affichage ou le bouton de commande des lumières.

026.289



Dimmer con ingresso in 24Vdc per moduli led in tensione costante (CV) di potenza massima 240W con integrato ricevitore wireless CASAMBI e dotato di ingresso ausiliario programmabile dall'applicazione. Questo permette di agire su qualsiasi dispositivo (o gruppi di dispositivi) presente all'interno della rete CASAMBI. Proponiamo l'abbinamento del dimmer in 24Vdc con il relativo alimentatore.

EN Dimmer with 24Vdc input for LED modules in constant voltage (CV) of maximum power of 240W with integrated CASAMBI wireless receiver and equipped with auxiliary input that can be programmed using the app. This allows you to use any device (or groups of devices) present within the CASAMBI network. We propose the combination of the 24Vdc dimmer with the relative power supply

DE Dimmer mit 24Vdc Eingang für LED-Module mit Konstanzspannung (CV) und max. 240 W Leistung mit integriertem kabellosem CASAMBI-Empfänger und über die Applikation programmierbarem Eingang. Dadurch kann jedes Gerät (oder Gerätegruppen) im CASAMBI-Netzwerk gesteuert werden. Wir schlagen die Kombination des 24Vdc Dimmers mit dem entsprechenden Netzgerät vor.

FR Variateur avec entrée en 24Vdc pour modules LED en tension constante (CV) d'une puissance maximale de 240W avec récepteur sans fil CASAMBI intégré et doté d'une entrée auxiliaire programmable depuis l'application. Cela permet de commander n'importe quel dispositif (ou des groupes de dispositifs) présent dans le réseau CASAMBI. Nous proposons l'association du variateur en 24Vdc avec l'alimentation correspondante

#### ALIMENTATORI 9010 COMPATIBILI CASAMBI / 9010 DRIVERS SUITABLE FOR CASAMBI / 9010 BETRIEBSGERÄTE CASAMBI KOMPATIBEL / ALIMENTATIONS 9010 COMPATIBLES CASAMBI

026.277



Alimentatore multipotenza per moduli LED in corrente costante (CC) di potenza massima 38W, fornito di dip-switch per la taratura dell'uscita con integrato ricevitore wireless CASAMBI e dotato di ingresso ausiliario programmabile dall'applicazione. Questo permette di agire su qualsiasi dispositivo (o gruppi di dispositivi) presente all'interno della rete CASAMBI.

EN Multi-power supply for LED modules with a constant current (CC) of maximum power of 38W, equipped with dip-switch for the output calibration with an integrated CASAMBI wireless receiver and equipped with auxiliary input that can be programmed using the app. This allows you to use any device (or groups of devices) present within the CASAMBI network.

DE Mehrleistungs-Netzgerät für LED-Module mit Konstantstrom (CC), max. 38 W Leistung, ausgestattet mit Dipschalter zur Ausgangsregelung mit integriertem kabellosem CASAMBI-Empfänger und über die Applikation programmierbarem Eingang. Dadurch kann jedes Gerät (oder Gerätegruppen) im CASAMBI-Netzwerk gesteuert werden.

FR Alimentation à puissances multiples pour modules LED en courant constant (CC) d'une puissance maximale de 38W, dotée de commutateur DIP pour l'étalonnage de la sortie avec récepteur sans fil CASAMBI intégré et doté d'une entrée auxiliaire programmable depuis l'application. Cela permet de commander n'importe quel dispositif (ou des groupes de dispositifs) présent dans le réseau CASAMBI.

026.288



Alimentatore per moduli led in tensione costante (CV) di potenza massima 35W con integrato ricevitore wireless CASAMBI e dotato di ingresso ausiliario programmabile dall'applicazione. Questo permette di agire su qualsiasi dispositivo (o gruppi di dispositivi) presente all'interno della rete CASAMBI.

EN Power supply for LED modules in constant voltage (CV) of maximum power of 35W with integrated CASAMBI wireless receiver and equipped with auxiliary input that can be programmed using the app. This allows you to use any device (or groups of devices) present within the CASAMBI network.

DE ANetzgerät für LED-Module mit Konstanzspannung (CV) mit max. 35 W Leistung und integriertem kabellosem CASAMBI-Empfänger und über die Applikation programmierbarem Eingang. Dadurch kann jedes Gerät (oder Gerätegruppen) im CASAMBI-Netzwerk gesteuert werden.

FR Alimentation pour modules LED en tension constante (CV) d'une puissance maximale de 35W, avec récepteur sans fil CASAMBI intégré et doté d'une entrée auxiliaire programmable depuis l'application. Cela permet de commander n'importe quel dispositif (ou des groupes de dispositifs) présent dans le réseau CASAMBI.

Art. 4178 / P011 - Private house - Barcelona, Spain  
Arch. Biagio Giarrizzo



App Casambi

ALIMENTAZIONE CASAMBI A CORRENTE COSTANTE

Constant current Casambi power supply / Casambi Konstantstrombetriebsgeräte / Alimentation en courant constant Casambi



C.C. [m.A.]	COD.	<b>026.277</b>				
	P [W]	18.9W	27W	35.7W	37.8W	37.8W
	OUT	350mA	500mA	700mA	900mA	1050mA

Codice <i>Code</i>	Potenza <i>Power</i>	Corrente <i>Current</i>	ARTICOLI COLLEGABILI <i>Connectable ARTICLES</i>			
3006	6.5W	350mA	2			
3006	2x6.5W	350mA	1			
3006	3x6.5W	350mA		NO		
3008	13W	700mA		2		
3008	2x13W	700mA		1		
3009	26W	700mA		1		
3010	18W	500mA		1		
3013	30W	700mA		1		
3014	52W	1400mA			1*	
				900mA=>-33W/3800lm		
3015	88W	2x1050mA			2*	
				2x900mA=>-74W/8700lm		
3019	8W	700mA		4		
3021	12W	350mA	1			
3024	8W	350mA	2			
3025	16W	700mA		2		
3028	25W	700mA		1		
3029	51W	1050mA		1*		
				700mA=>-34W/4700lm		
3031	16.5W	700mA		2		
3032	21.5W	700mA		1		
3033	16.5W	700mA		2		
3034	32W	1050mA				1
3036	2x6.5W	700mA		2		
3039	4W	350mA	4			
3039	2x4W	350mA	2			
3039	3x4W	350mA	1			
3039	4x4W	350mA	1			
3040	6W	500mA		4		
3040	2x6W	500mA		2		
3040	3x6W	500mA		1		
3041	11W	900mA			3	
30135	8.5W	700mA		4		
30135	17W	700mA		2		
30135	34W	700mA		1		
30150	4W	200mA			NO	
30150	2x4W	200mA			NO	
30151	6.5W	350mA	2			
30151	2x6.5W	350mA	1			
30152	13W	700mA		2		
30153	4W	200mA			NO	
30153	2x4W	200mA			NO	
30154	6.5W	350mA	2			
30154	2x6.5W	350mA	1			
30155	13W	700mA		1		
30156	9W	700mA		4		

ALIMENTAZIONE CASAMBI A TENSIONE COSTANTE

Constant voltage Casambi power supply / Casambi Konstantspannungsbetriebsgeräte / Alimentation en tension constante Casambi



C.V. [V]	COD.	<b>026.288</b>	<b>026.259 +</b> <b>026.289</b>	<b>026.260 +</b> <b>026.289</b>	<b>026.261 +</b> <b>026.289</b>	<b>026.262 +</b> <b>026.289</b>
	P [W]	35W	36W	60W	150W	240W
	OUT	24Vdc	24Vdc	24Vdc	24Vdc	24Vdc

ALIMENTAZIONE CASAMBI STRIP LED

Power supply Casambi strip LED / Casambi Betriebsgeräte LED Bänder / Alimentation Casambi Ruban LED

C.V. [V]	COD.	<b>026.288</b>	<b>026.259 +</b> <b>026.289</b>	<b>026.260 +</b> <b>026.289</b>	<b>026.261 +</b> <b>026.289</b>	<b>026.262 +</b> <b>026.289</b>
	P [W]	35W	36W	60W	150W	240W
	OUT	24Vdc	24Vdc	24Vdc	24Vdc	24Vdc

Codice <i>Code</i>	Potenza <i>Power</i>	STRIP LED COLLEGABILI <i>Connectable LED Strips</i>				
021.790.050	7.5W	4	4	8	20	32
021.790.100	15W	2	2	4	10	16
021.790.150	22.5W	1	1	2	6	10
021.790.200	30W	1	1	2	5	8
021.790.300	45W			1	3	5
021.790.500	75W				2	3
021.791.050	9W	3	3	6	16	26
021.791.100	18W	1	1	3	8	13
021.791.150	27W	1	1	2	5	8
021.791.200	36W			1	4	6
021.791.300	54W			1	2	4
021.791.500	90W				1	2
121.792.050	13W	2	2	4	11	18
021.792.100	26W	1	1	2	5	9
021.792.150	39W			1	3	6
021.792.200	52W			1	2	4
021.792.300	78W				1	3
021.792.500	130W				1	1
021.793.050	5W	7	7	12	30	48
021.793.100	10W	3	3	6	15	24
021.793.150	15W	2	2	4	10	16
021.793.200	20W	1	1	3	7	12
021.793.300	30W	1	1	2	5	8
021.793.500	50W			1	3	4

Codice <i>Code</i>	Potenza <i>Power</i>	ARTICOLI COLLEGABILI <i>Connectable ARTICLES</i>				
3000	2W	17	17	30	75	120
3001	3.5W	10	10	17	42	68
3002	4.5W	7	7	13	33	53
3002	5.5W	6	6	10	27	43
3003	1.5W	23	23	40	100	160
3003	2.5W	13	13	24	60	96
3003	4W	8	8	15	37	60
3003	5.5W	6	6	10	27	43
3003	6.5W	5	5	9	23	36
3003	8W	4	4	7	18	30
3003	9.5W	3	3	6	15	25
3003	10.5W	3	3	5	14	22
3003	13.5W	2	2	4	11	17
3003	14.5W	2	2	4	10	16
3003	16W	2	2	3	9	15
3003	21W	1	1	2	7	11
3003	23.5W	1	1	2	6	10
3003	24W	1	1	2	6	10
3003	32W	1	1	1	4	7
3003	37W			1	4	6
3003	39W			1	3	6
3003	50W			1	3	4
3003	52W			1	2	4
3003	55W			1	2	4
3003	60W				2	4
3004	1.1W	31	31	54	136	218
3004	2.2W	15	15	27	68	109
3004	5.5W	6	6	10	27	43
3004	6.5W	5	5	9	23	36
3005	9.5W	3	3	6	15	25
3004	12W	2	2	5	12	20
3004	19W	1	1	3	7	12
3004	19.5W	1	1	3	7	12
3004	21W	1	1	2	7	11
3005	28.5W	1	1	2	5	8
30149	5x1W	6	6	11	28	46

Si sta diffondendo sempre di più la tecnologia Tunable White che permette di impostare la temperatura colore ideale per il proprio ambiente, correttamente abbinata all'orario di utilizzo. Questa particolare tipologia di led, unita al controllo CASAMBI, contribuisce a donare una sensazione di benessere in qualsiasi tipologia di ambiente, tanto più in uffici e zone commerciali, dove le persone trascorrono molto tempo.

DE Die Tunable-White-Technologie setzt sich immer mehr durch, da sie die Regelung der idealen Farbtemperatur für jedes Ambiente in Verbindung mit der Zeiteinstellung ermöglicht. Dieser besondere LED-Typ sorgt gemeinsam mit der CASAMBI-Steuerung für das Wohlbefinden in jeder Umgebung, auch in Büro- und Geschäftsräumen, wo sich die Personen lange Zeit aufhalten.

FR La technologie Tunable White est de plus en plus répandue. Elle consiste à régler la température de couleur idéale pour la pièce, en l'associant à un horaire d'utilisation. Ce type de LED particulier, avec la commande CASAMBI, contribue à donner une sensation de bien-être dans tous les types de pièces, en particulier dans les bureaux et les zones commerciales, où les gens passent beaucoup de temps.

EN The Tunable White technology is increasingly becoming more widespread. It allows to set the ideal colour temperature for your environment and correctly combine it with the time of use. This particular type of LED, combined with the CASAMBI control, helps give a feeling of well-being in any type of environment, including offices and commercial areas, where people spend a lot of time.

### ALIMENTATORI 9010 COMPATIBILI CASAMBI PER LA GESTIONE DEL TUNABLE WHITE / CASAMBI COMPATIBLE 9010 POWER SUPPLIES FOR THE MANAGEMENT OF TUNABLE WHITE / CASAMBI-KOMPATIBLE NETZGERÄTE FÜR DIE STEUERUNG DES TUNABLE WHITE / ALIMENTATIONS 9010 COMPATIBLES CASAMBI POUR LA GESTION DU TUNABLE WHITE

026.287



Alimentatore multipotenza per moduli LED in corrente costante (CC) di potenza massima 38W, fornito di resistenze per la taratura dell'uscita con integrato ricevitore wireless CASAMBI e dotato di ben 2 ingressi ausiliari programmabili dall'applicazione. Questi permettono di agire su qualsiasi dispositivo (o gruppi di dispositivi) presenti all'interno della rete CASAMBI.

EN Multi-power supply for constant current (DC) LED modules with a maximum power of 38W, equipped with resistors for the calibration of the output with integrated wireless CASAMBI receiver and equipped with 2 auxiliary inputs that can be programmed using the app. These allow to use any device (or groups of devices) present within the CASAMBI network.

DE Mehrleistungs-Netzgerät für LED-Module mit Konstantstrom (CC) mit max. 38 W Leistung, ausgestattet mit Widerständen zur Ausgangsregelung mit integriertem kabellosem CASAMBI-Empfänger. Die 2 über App programmierbaren Hilfseingänge dienen zum Steuern jedes Geräts (oder Gerätegruppe) im CASAMBI-Netz.

FR Alimentation à puissances multiples pour modules LED en courant constant (CC) d'une puissance maximale de 38W, dotée de résistances pour l'étalonnage de la sortie avec récepteur sans fil CASAMBI intégré doté de 2 entrées auxiliaires programmables depuis l'application. Cela permet de commander n'importe quel dispositif (ou des groupes de dispositifs) présent dans le réseau CASAMBI.

026.278



Dimmer con ingresso in 24Vdc e 4 uscite che permettono di gestire articoli e strip led Tunable White o RGBW in tensione costante (CV) con integrato ricevitore wireless CASAMBI e dotato di ben 4 ingressi ausiliari programmabili dall'applicazione. Questi permettono di agire su qualsiasi dispositivo (o gruppi di dispositivi) presenti all'interno della rete CASAMBI. Proponiamo l'abbinamento del dimmer in 24Vdc con il relativo alimentatore

EN Dimmer with 24Vdc input and 4 outputs that allow to manage Tunable White or RGBW items and LED strips in constant voltage (CV) with integrated CASAMBI wireless receiver and equipped with 4 auxiliary inputs that can be programmed using the app. These allow to use any device (or groups of devices) present within the CASAMBI network. We propose the combination of the 24Vdc dimmer with the relative power supply

DE Dimmer mit 24Vdc Eingang und 4 Ausgängen zum Steuern von Leuchten und Ledstreifen mit Tunable White oder RGBW mit Konstantspannung (CV) mit integriertem kabellosem CASAMBI-Empfänger. Die 4 über App programmierbaren Hilfseingänge dienen zum Steuern jedes Geräts (oder Gerätegruppe) im CASAMBI-Netz. Wir schlagen die Kombination des 24Vdc Dimmers mit dem entsprechenden Netzgerät vor.

FR Variateur avec entrée en 24Vdc et 4 sorties permettant de gérer des articles et des rubans LED Tunable White ou RGBW en tension constante (CV) avec récepteur sans fil CASAMBI intégré et doté de 4 entrées auxiliaires programmables depuis l'application. Cela permet de commander n'importe quel dispositif (ou des groupes de dispositifs) présent dans le réseau CASAMBI. Nous proposons l'association du variateur en 24Vdc avec l'alimentation correspondante

COD.	026.287				2x026.287
P [W]	17.5W	25W	35W	37.98W	37.98W
OUT	350mA	500mA	700mA	900mA	2x900mA

Codice Code	Potenza Power	Tonalità Colour Temperature	Lumen	Corrente Current	ARTICOLI COLLEGABILI Connectable ARTICLES			
4046-TW25	16W	2700-5700°K	2250-2400lm	700mA		1-2		
4105-TW25	16W	2700-5700°K	2250-2400lm	700mA		1-2		
4113-TW13	30W	2700-5700°K	4200-4500lm	700mA		1		
4114-TW13	30W	2700-5700°K	4200-4500lm	700mA		1		
4118-TW15	74W	2700-5700°K	10300-11000lm	2x900mA				1
4122-TW15	74W	2700-5700°K	10300-11000lm	2x900mA				1
4193B-TW25	16W	2700-5700°K	2250-2400lm	700mA		1-2		
8935B-TW14	33W	2700-5700°K	4600-4950lm	900mA			1	
8935C-TW15	74W	2700-5700°K	10300-11000lm	2x900mA				1
8936A-TW13	30W	2700-5700°K	4200-4500lm	700mA		1		
8936B-TW14	33W	2700-5700°K	4600-4950lm	900mA			1	
8937A-TW28	25W	2700-5700°K	3500-3750lm	700mA		1		

## STRIP LED TUNABLE WHITE E RELATIVI ALIMENTATORI:

Tunable white led strips and power supplies / LED Bänder mit Tunable White und Betriebsgeräte / Rubans LED avec Tunable White et alimentations

021.794

	Tonalità Colour Temperature	Potenza Power	Flusso Light Output	LED	Tensione Voltage	LED/m	Larghezza Width	Tagliabile ogni Cuttable	CRI	IP
021.794	2700°K 6000°K	20W/m	1800lm/m 2200lm/m	2835	24Vdc	160	10mm	50mm	85	IP20

COD.	026.259 +	026.260 +	026.261 +
	026.278	026.278	026.278
P [W]	36W	60W	150W
OUT	24Vdc	24Vdc	24Vdc

Codice P.E. Code	Potenza Power	Tonalità Colour Temperature	Lumen	Tensione Voltage	ARTICOLI COLLEGABILI Connectable ARTICLES		
021.794.050	10W+10W	2700-6000°K	900-1100lm	24Vdc	1-3	1-6	1-15
021.794.100	20W+20W	2700-6000°K	1800-2200lm	24Vdc	1	1-3	1-7
021.794.150	30W+30W	2700-6000°K	2700-3300lm	24Vdc	1	1-2	1-5
021.794.200	40W+40W	2700-6000°K	3600-4400lm	24Vdc		1	1-3
021.794.300	60W+60W	2700-6000°K	5400-6600lm	24Vdc		1	1-2
021.794.500	100W+100W	2700-6000°K	9000-11000lm	24Vdc			1



Art. 4046



### Collegamento solo emergenza

Emergency only connection

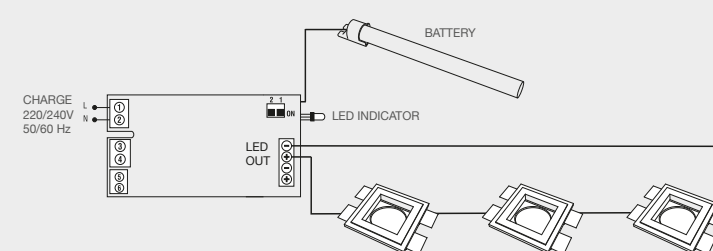

### Collegamento emergenza + illuminazione ordinaria

Emergency connection + standard lighting

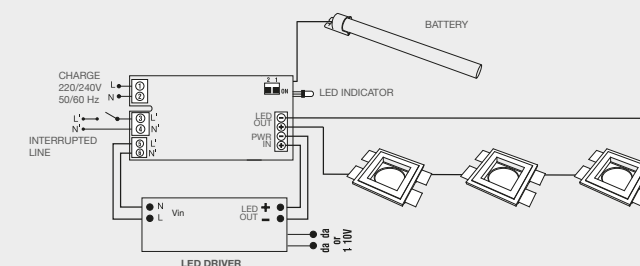

### Caratteristiche principali

- Funzionamento in sola emergenza
- Funzionamento in emergenza e luce continua in abbinamento con l'alimentatore standard o dimmerabile
- Assicura 1h di autonomia con ricarica di 12 ore
- Versione multipotenza regolabile con dip-switch
- Intervento istantaneo ad ogni mancanza di rete
- Batterie al NiCd in grado di funzionare ad alta temperatura ermetica
- Dispositivo di protezione contro le scariche prolungate
- Tipo di protezione IP20
- Conformità alle norme EN61347-2-13, EN61347-2-7, EN61547, EN55015, EN60598-2-22, EN61000-3-2, SELV
- Collegamento in scatola remota con l'eventuale alimentatore standard o dimmerabile

#### EN Main features

- Use as emergency kit only
- Emergency and continuous light in combination with the standard or dimmable power supply
- 1hour operational autonomy after 12-hour charging
- Adjustable multi power version with dip-switch
- Instant response at any power failure
- "High temperature" NiCd sealed batteries
- Protection device against extensive discharge
- IP20 protection index
- Compliance with standards EN61347-2-13, EN61347-2-7, EN61547, EN55015, EN60598-2-22, EN61000-3-2, SELV
- Connection in remote box with the standard or dimmable power supply, if present.

#### DE Hauptmerkmale

- Betrieb nur im Notfall
- Notbetrieb und Dauerlicht in Verbindung mit Standard- oder dimmbarem Netzgerät
- 1h garantierter Betrieb mit 12 Stunden Aufladung
- Mehrleistungsausführung mit DIP-Schalter regelbar
- Sofortiges Einschalten bei Netzausfall
- Hermetische NiCd-Batterie für den Betrieb bei hohen Temperaturen
- Schutzvorrichtung gegen lange Entladungen
- Schutzart IP20
- Entspricht den Normen EN61347-2-13, EN61347-2-7, EN61547, EN55015, EN60598-2-22, EN61000-3-2, SELV
- Anschluss in dezentralem Gehäuse mit Standard- oder dimmbarem Netzgerät

#### FR Caractéristiques principales

- Fonctionnement en urgence uniquement
- Fonctionnement en urgence et lumière continue avec alimentation standard ou à variateur :
- Garantit 1 h d'autonomie avec une recharge de 12 heures
- Version puissances multiples réglable avec commutateur DIP
- Intervention instantanée à chaque manque de réseau
- Batteries avec NiCd en mesure de fonctionner à haute température étanche
- Dispositif de protection contre les décharges prolongées
- Type de protection IP20
- Conforme aux normes EN61347-2-13, EN61347-2-7, EN61547, EN55015, EN60598-2-22, EN61000-3-2, SELV
- Branchement dans un boîtier distant avec l'éventuelle alimentation standard ou à variateur

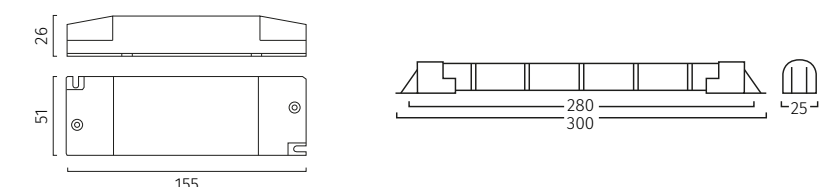

Scheda tecnica disponibile su [www.9010.it/kit-di-emergenza](http://www.9010.it/kit-di-emergenza)  
Data sheet available on [www.9010.it/kit-di-emergenza](http://www.9010.it/kit-di-emergenza)  
Datenblatt verfügbar unter [www.9010.it/kit-di-emergenza](http://www.9010.it/kit-di-emergenza)  
Fiche technique disponible sur [www.9010.it/kit-di-emergenza](http://www.9010.it/kit-di-emergenza)

# SISTEMI DI INSTALLAZIONI

Installation systems  
Installationssysteme  
Systèmes d'installation

SISTEMI DI INCASSO <i>Installation systems</i>	CASSAFORME <i>Housing box</i>	INSTALLAZIONE PROFILI <i>Profiles installation</i>	TUTORIAL VIDEO
p.420	p.422	p.424	p.427

# SISTEMI DI INCASSO

Installation systems / Einbausysteme / Système de montage

# SISTEMA MULTITAGLIA

Multi-size system



- 1. Tagliare**  
Cut / Schneiden / Couper

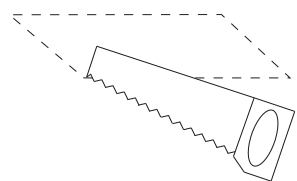

- 2. Avvitare lamelle**  
Screw metal strips / Metallstreifen einschrauben / Visser les ailettes metaliques

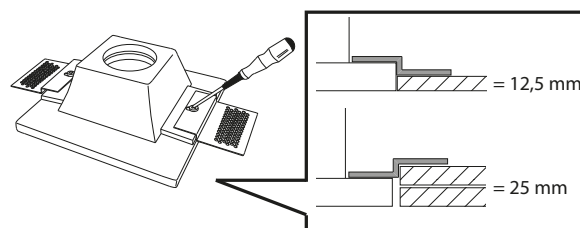

- 3. Posizionare articolo**  
Insert the article / Artikel einsetzen / Insérer l'article

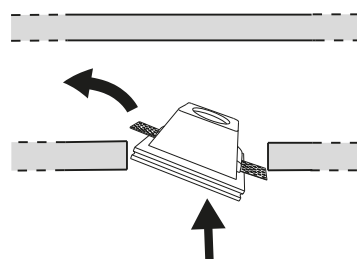

- 4. Fissare viti**  
Fix screws / Schrauben befestigen / Fixer les vis

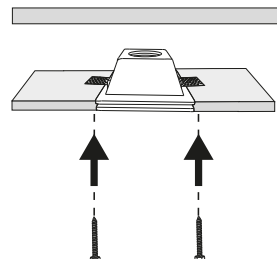

- 5. Prima stuccatura**  
First plaster finish / Erster Verputz / Première passe de l'enduit

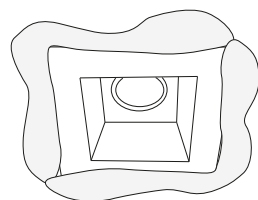

- 6. Nastro a rete**  
Joint reinforcing Tape / Verstärkungsband / Fixation de la bande placo plâtre

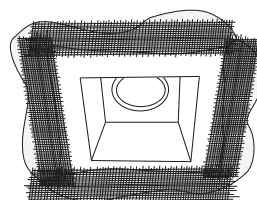

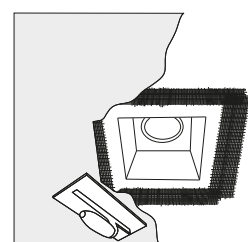

- 7. Seconda stuccatura**  
Second plaster finish / Zweiter Verputz / Seconde passe de l'enduit



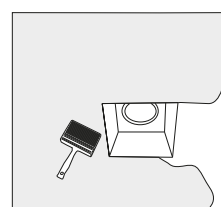

- 8. Pittura**  
Painting / Malerei / Peinture



Gli articoli 9010 contrassegnati dal simbolo  sono dotati del sistema "multitaglia", ovvero prevedono la possibilità, grazie ad una particolare staffa di fissaggio, di essere installati indifferentemente su cartongesso in singola lastra da 12.5mm o doppia lastra da 25mm. Su richiesta è disponibile un kit per l'installazione su singola lastra da 15mm o doppia lastra da 30mm

EN The 9010 articles marked with this symbol  are equipped with a "multisize" system. Thanks to the special metal fixing wings, such products can be installed either in 12.5mm thickness single plasterboard or in 25mm thickness double plasterboard. Available on request a special kit for 15mm thickness single plasterboard or 30mm thickness double plasterboard.

DE Die mit dem Symbol  gekennzeichneten Artikel 9010 sind mit dem "Mehrgrößensystem" ausgestattet. Dank eines speziellen Befestigungsbügels können sie beliebig auf Gipskartonplatten mit 12,5 mm Einzelbeplankung oder 25 mm Doppelbeplankung installiert werden. Auf Wunsch ist außerdem eine Ausrüstung zum Installieren auf 15 mm Einzelplatte oder 30 mm Doppelplatte erhältlich.

FR Les articles 9010 marqués par le symbole  sont dotés du système "multi-dimensions"; c'est-à-dire qu'ils prévoient la possibilité, grâce à un étrier de montage particulier, d'être installés indifféremment sur une plaque de plâtre de 12,5 mm ou sur une plaque double de 25 mm. Un kit d'installation sur plaque simple de 15 mm ou plaque double de 30 mm est disponible sur demande.

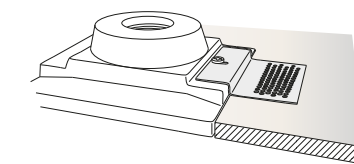

= 12,5 mm

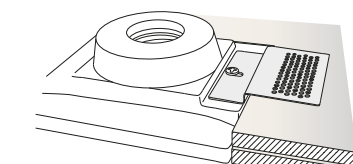

= 25,00 mm

## ADVANCED MOUNTING SYSTEM

ADVANCED MOUNTING SYSTEM

Gli articoli del catalogo 9010 sono proposti con l'"Advanced Mounting System": lungo tutto il perimetro esterno dell'articolo uno scalino di un paio di millimetri permette una applicazione facilitata della retina. Questo permette inoltre che in fase di stuccatura/ rifinitura non si vada a toccare la parte in vista dell'articolo.

EN The articles of the 9010 catalogue are also equipped with the "Advanced Mounting System". The external perimeter of the downlight has a 2 mm step that improves the application of the joint reinforcing tape. Furthermore finishing and plastering of the product is more precise, avoiding unpleasant imperfections on the plaster surface of the product

DE Die Artikel 9010 sind mit dem "Advanced Mounting System" ausgestattet: Am Außenumfang des Produkts befindet sich eine Abstufung von ein paar Millimetern, um das Abdeckband leichter einzusetzen. Dadurch wird verhindert, dass der sichtbare Teil des Produkts beim Spachteln und Fertigbearbeiten verletzt wird.

FR Les articles 9010 sont disponibles avec l'"Advanced Mounting System": sur tout le contour externe de l'article, une ailette de quelques millimètres permet d'appliquer facilement la trame. Pendant l'étape de jointoiement/ finition, cela permet également de ne pas toucher la partie visible de l'article.

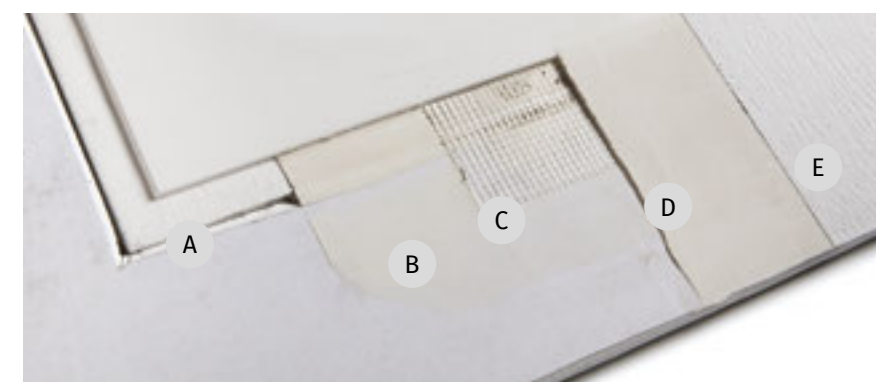

**A. Articolo** / Article / Artikel / Article

**B. Prima stuccatura** / First plaster finish / Erster Verputz / Première passe de l'enduit

**C. Nastro a rete** / Joint reinforcing Tape / Verstärkungsband / Fixation de la bande placo plâtre

**D. Seconda stuccatura** / Second plaster finish / Zweiter Verputz / Seconde passe de l'enduit

**E. Intonaco** / Last finish / Letzter Verputz / Enduit final

# CASSAFORMA per calcestruzzo / laterizio

HOUSING BOX for concrete / brickwork / EINBAUGEHÄUSE für Betonwand / Mauer /  
BOÎTIER ENCASTREMENT pour béton / briques

Il sistema delle controcasse permette il montaggio degli spot ad incasso anche nelle pareti in calcestruzzo o laterizio

EN The Housing Box system allows to mount the spotlights into concrete or brickwork

DE Die Montage der Einbaueinheit erlaubt es, die Strahler in Betonwand oder Mauer zu installieren

FR Le système de la boîte de réservation permet l'installation des produits encastrés dans les surfaces en béton ou en brique

- 1. Piegare nella sequenza indicata dai bollini**  
Bend according to stickers sequence / Biegen Sie nach Aufkleberreihenfolge / Plier selon la séquence des autocollants

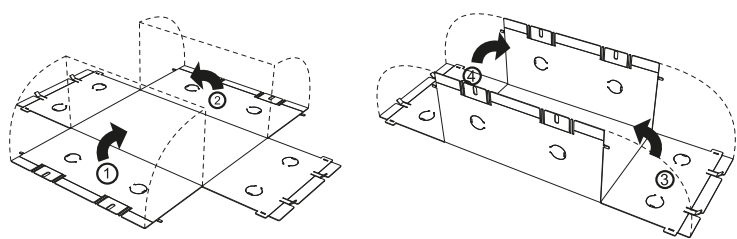

- 2. Piegare l'aletta di chiusura**  
Bend the metal fixing strip / Biegen Sie den Befestigungsstreifen / Plier la bande de fixation

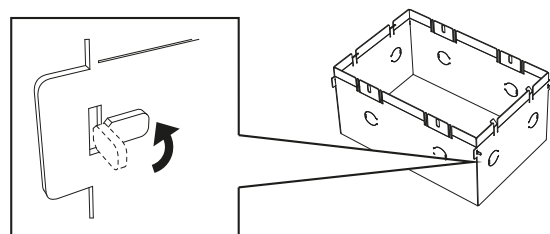

- 3. Piegare verso l'interno per il passaggio dei tubi**  
Bend inwards to insert the tubes / Biegen Sie, um die Röhren einzusetzen / Plier vers l'intérieur pour insérer les tubes

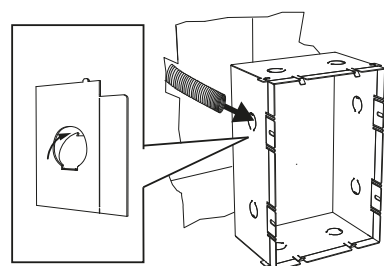

- 4. Murare a livello dell'intonaco**  
Cement with the level of the cement mortar / Zementieren Sie bündig mit dem Zementmörtel / Enduire au ras du niveau du mortier

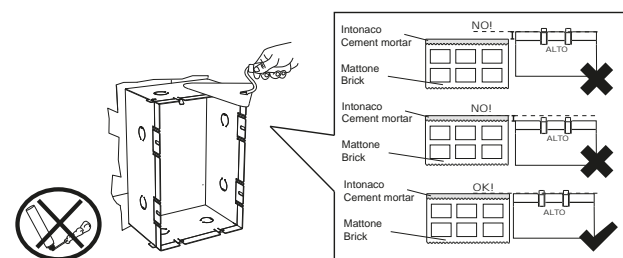

- 5. Staccare tutte le lamelle di tipo A**  
Remove type A metal strip / Entfernen Sie den Metallstreifen Typ A / Retirer les bandes type A

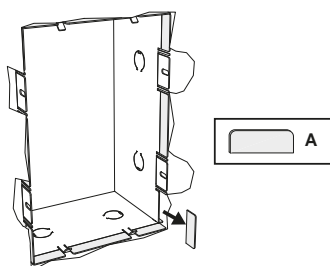

- 6. Staccare le lamelle di tipo B e fissarle sull'articolo con sistema MULTISIZE**  
Remove type B metal strip and fix them onto the MULTISIZE article / Entfernen Sie den Metallstreifen Typs B und auf dem Artikel MULTISIZE befestigen / Retirez les bandes type B et les fixer sur l'article avec le système MULTISIZE

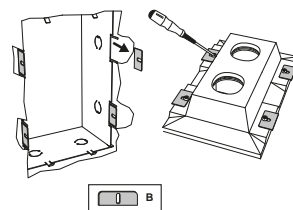

- 7. Inserire l'articolo a filo intonaco**  
Insert with the level of the cement mortar / Legen Sie den Artikel bündig mit dem Zementmörtel / Insérer l'article affleure de la surface enduite

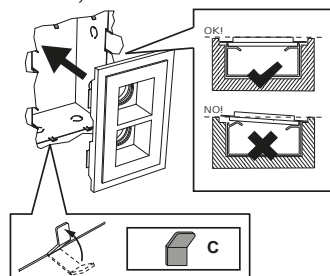

- 8. Piegare i piolini di tipo D per fissare l'articolo**  
For fixing the article, bend the type D metal pins / Biegen Sie zum Fixieren des Artikels die Metallstreifen des Typs D / Pour fixer l'article, pliez les bandes type D

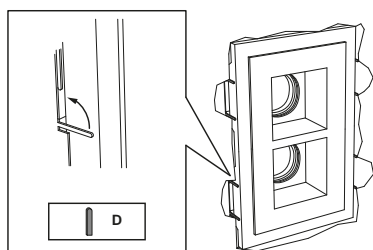

- 9. Stuccatura e rasatura finale**  
Final plastering and smoothing / Verputzen und glätten / Enduit final et lissage

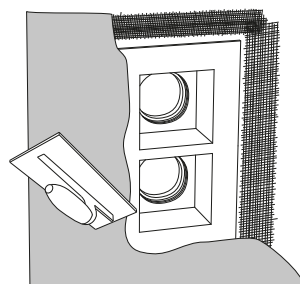

CODICE Code	MISURA Measure	MISURA FORO Hole size	ARTICOLI Article
023.402	125x125x130	155x155x140	4176 4181
023.408	325x285x100	355x315x110	2365B 4099 4198 4201 4202
023.411	105x115x70	135x145x80	4053 4054
023.414	185x205x105	215x235x115	4174 4177 4178
023.415	485x185x115	515x215x125	4180 4218 4218A 4219 4179
023.416	155x155x130	185x185x140	4112 4156 2417 2436 2446 4167 4164 4199
023.421	125x125x60	155x155x70	4044B 4045C 4215 4216 4175 4183 5505A 5505B 5505C 5505D 5505E
023.422	305x115x50	335x145x60	4184 5505F 2466B 4247A 4248A 4249A 4250A 4251A 4252A
023.436	105x410x80	135x440x90	4275 4276 4277 4278 4280 4281
023.437	525x185x50	555x215x60	4155B 4058 4062
023.438	315x245x50	345x275x60	4052 4180A 4180B 4196D
023.444	325x205x65	355x235x75	4210 2416B 4105 4039B 4040B 2369A 2371A
023.446	125x225x85	155x255x95	
023.447	125x160x85	155x190x95	
023.447	200x200x120	230x230x130	
023.448	190x190x125	220x220x135	
023.449	195x165x50	225x195x60	
023.450	105x105x65	135x135x75	
023.451	125x125x100	155x155x110	
023.452	140x200x55	170x230x65	
023.453	145x125x70	175x155x80	
023.454	335x185x115	365x215x125	
023.456	235x155x115	265x185x125	
023.457	295x155x115	325x185x125	
023.458	290x180x120	320x210x130	
023.460	615x360x110	645x390x120	
023.471	175x140x75	205x170x85	
023.475	265x265x150	295x295x160	
023.476	355x305x50	385x335x60	

CODICE Code	MISURA Measure	MISURA FORO Hole size	ARTICOLI Article
023.477	255x255x170	285x285x180	4045B 2486C 4154B 2486D 2486E 2486F 4195A 4195B 4195C 4195D
023.478	140x140x75	170x170x85	2414B 2415B 2416A 2446B 2508A 2508F 2402F 2402G
023.479	210x260x90	240x290x100	2619 4193 4194 2618 2365E 2416E
023.486	470x170x85	500x200x95	4100E 4100F 4100G 4204B 2484A 2485A 2486A 2485B 4196H 2508C 2508H 2484B 2485C 2486B 4196N
023.487	465x255x85	495x285x95	2484C 2416C 2446B 4247E 4248E 4249E 4250E 4248F 4249F
023.488	410x340x85	440x370x95	2365G 2416D 2508B 2508G
023.489	210x140x85	240x170x95	2508G
023.490	320x320x85	350x350x95	
023.491	205x405x75	235x435x85	
023.492	210x220x30	240x250x40	
023.495	220x220x75	250x250x85	
023.496	95x185x70	125x215x80	
023.497	95x285x70	125x315x80	
023.498	95x390x70	125x420x80	
023.499	95x255x65	125x285x75	
023.4003	405x145x80	435x175x90	
023.4004	555x145x85	585x175x95	
023.4005	705x145x80	735x175x90	
023.4006	1005x145x65	1035x175x75	
023.4008	305x465x85	335x495x95	
023.4010	235x140x45	265x170x55	
023.4011	305x140x45	335x170x55	
023.4012	405x255x80	435x285x90	
023.4013	315x145x85	345x175x95	
023.4014	155x155x140	185x185x150	
023.4015	155x325x140	185x355x150	
023.4016	155x495x140	185x525x150	
023.4100	110x150x50	140x180x60	
023.4101	110x200x50	140x230x60	
023.4102	110x250x50	140x280x60	

# INSTALLAZIONE A REGOLA D'ARTE

Professional installation / Professionelle Installation / Installation professionnelle

Pochi e precisi passaggi per ottenere dei perfetti risultati estetici e duraturi nel tempo con profili in ALUMITE®. Il fissaggio dei profili alle lastre in cartongesso deve essere eseguito con viti autoforanti per cartongesso distanziate non più di 22 cm l'una dall'altra. Utilizzando per la stuccatura e rasatura rispettivamente: Uniflott e Fugenfueller della ditta **KNAUF**, è garantita una installazione a regola d'arte.

EN Few and precise instructions to get long-lasting and esthetically perfect results with ALUMITE® profiles. The fastening of the profiles to the plasterboard can be carried out with common self-tapping screws spaced no more than 22 cm from each other. Using Uniflott and Fugenfueller from the company **KNAUF** for filling and finishing, a professional installation is guaranteed.

DE Wenige präzise Hinweise, um perfekte ästhetische und auf Dauer haltbare Ergebnisse mit den ALUMITE®-Profilen zu erzielen. Die Befestigung der Profile an den Gipsplatten erfolgt mit herkömmlichen selbstschneidenden Gipsplattenschrauben in einem Abstand von nicht mehr als 22 cm zueinander. Um die Produkte fachgerecht zu installieren, verwenden Sie die Produkte UNIFLOTT und FUGENFÜLLER der Firma **KNAUF** für eine garantiert fachgerechte Installation.

FR Il suffit de quelques étapes précises pour obtenir des résultats esthétiques parfaits et durables dans le temps avec les profilés en ALUMITE®. La fixation des profilés dans le placo-plâtre, doit s'effectuer avec des vis auto-perforantes adaptées à ce type de matériau et espacées au maximum de 22 cm l'une de l'autre. En utilisant respectivement les techniques d'enduisage et lissage des produits : Uniflott et Fugenfueller de la Maison **KNAUF** assurent une installation dans les règles de l'art.

**1.**

## Fissare con le viti

Fix with screws  
Mit Schrauben befestigen  
Fixation avec vis

**2.**

## Posizionare lo schermo usa-getta

Position the disposable screen  
Einweg-Abdeckung positionieren  
Placer le diffuseur à usage unique

**3.**

## Stuccare

Plaster  
Verputzen  
Enduire

**4.**

## Colorare

Colour  
Färben  
Colorer

**5.**

## Incidere e togliere lo schermo usa-getta

Cut and remove the disposable screen  
Einschneiden und Einweg-Abdeckung abnehmen  
Couper et enlever le diffuseur à usage unique

**6.**

## Inserire LED

Insert led  
Strip Led einlegen  
Insérer le LED

**7.**

## Posizionare schermo definitivo

Apply the final screen  
Abdeckung aufdrücken  
Appliquer le diffuseur opal définitif

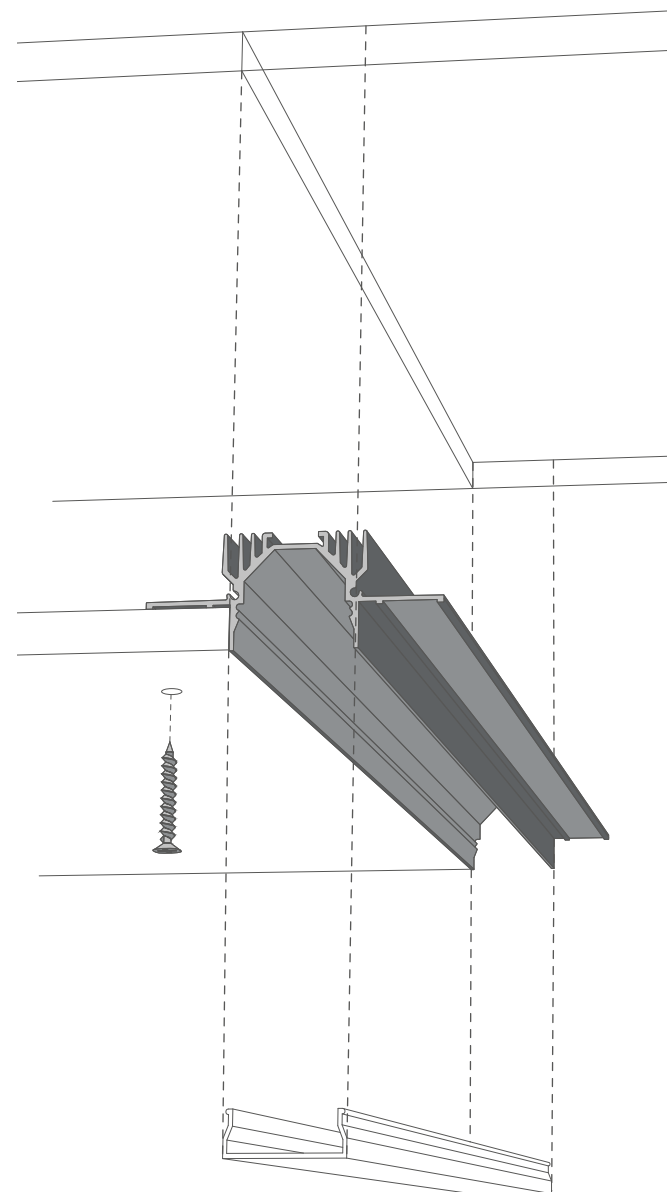

# INSTALLAZIONE SU LATERIZIO

Installation on brickwork / Einbau auf Mauerwerk / Installation sur briques

I nostri profili P002 – P003 – P004 – P012 – P013 possono essere installati sia su muratura in laterizio sia su cemento con le normali attrezzature presenti in cantiere e non necessitano di controscassa.

EN Our profiles P002 – P003 – P004 – P012 – P013 can be installed into brickwork and concrete wall or ceiling with standard tools present on all building sites and do not need the housing box.

DE Unsere Profil le P002 – P003 – P004 – P012 – P013 können auf Mauerwerk oder auf Betonwand mit den Standardwerkzeugen einer Baustelle montiert werden; Einbaugeschäube werden nicht benötigt.

FR Nos profilés P002 – P003 – P004 – P012 – P013 peuvent être installés sur les surfaces en béton et briques avec les équipements normaux présents sur le site et ne nécessitant pas de revêtement extérieur.



**1.**

## Preparare la scanalatura

Arrange wall chases  
Mauerschlitze ausführen  
Préparer une saignée dans le mur



**2.**

## Fissare con le viti

Fix with screws  
Mit Schrauben befestigen  
Fixation le profilés avec les vis



**3.**

## Intonacare

Plaster  
Verputzen  
Enduire



**4.**

## Rimuovere lo schermo protettivo solo a fine tinteggiatura

Remove protective screen only after the final painting  
Schutz-Abdeckung nur nach der Wandlackierung entfernen  
Enlevez la couverture de protection seulement après la peinture finale

# INSTALLAZIONE RAPIDA CON P012 - P013

Quick installation with P012 - P013 / Schnelle Installation mit P012 - P013 /  
Installation rapide avec P012 - P013

9010 presenta i profili P012 e P013 a luce diretta rispettivamente da 15 e 30mm che permettono un notevole risparmio di tempo in fase di installazione, in particolare nel realizzare la struttura portante del soffitto o della parete.

EN 9010 presents the P012 and P013 profiles with direct light respectively with a 15 and 30 mm length allowing for considerable time saving during installation, in particular when creating the ceiling or wall supporting structure.

DE 9010 präsentiert die Stromschienen P012 und P013 mit direktem Licht, Größe 15 bzw. 30 mm, für die Zeiteinsparung bei der Installation, besonders dann, wenn der tragende Aufbau für Decke und Wand erstellt werden muss.

FR 9010 présente les profils P012 et P013 à lumière directe, respectivement de 15 et 30 mm, qui permettent de réaliser une économie de temps considérable pendant l'installation, en particulier lors de la réalisation de la structure portante du plafond ou du mur.

## 1.

I profili P012 e P013 possono essere fissati direttamente alla struttura

EN The P012 and P013 profiles can be fixed directly to the structure  
DE Die Profile P012 und P013 können direkt an der Struktur befestigt werden.

FR Les profils P012 et P013 peuvent être fixés directement sur la structure



## 2.

Ed essere tamponati in seguito con lastre in cartongesso da 12.5mm

EN And be plugged subsequently with 12.5 mm plasterboard sheets  
DE Sie werden danach mit 12,5 mm starken Gipsplatten ausgefacht  
FR Et être recouverts plus tard de plaques de placoplâtre de 12,5 mm

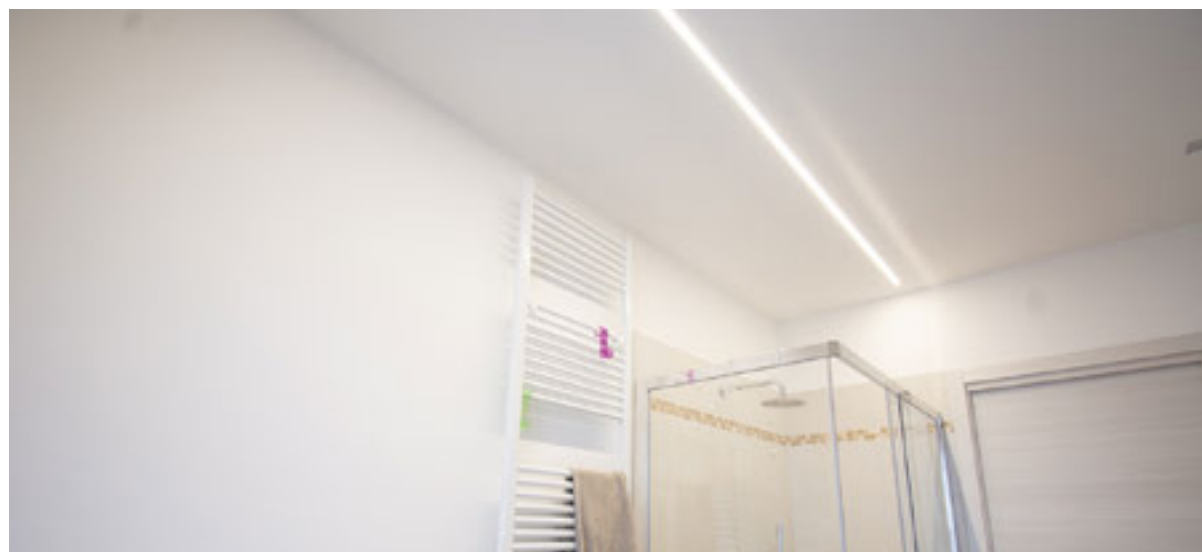

# TUTORIAL



INSTALLAZIONE CASSAFORMA /  
INSTALLATION OF THE HOUSING BOX /  
EINBAU GEHÄUSE INSTALLATION /  
INSTALLATION BOITIER ENCASTREMENT

VAI AL TUTORIAL  
GO TO THE TUTORIAL



INSTALLAZIONE STRIP LED /  
STRIP LED INSTALLATION /  
STRIP LED INSTALLATION /  
INSTALLATION RUBAN LED

VAI AL TUTORIAL  
GO TO THE TUTORIAL



CHIUSURA CASSAFORMA /  
ASSEMBLY OF THE HOUSING BOX /  
EINBAU GEHÄUSE MONTAGE /  
MONTAGE BOITIER ENCASTREMENT

VAI AL TUTORIAL  
GO TO THE TUTORIAL



# DESIGNER



**GHIRARDELLO**

2511 / 5290 / 5289A / 5289B



**BERALDI**

2496 / 2497 / 5291



**HARARI**

2623



**AMARANTOSTUDIO**

8935B / 8935C



**STIMAMIGLIO**

M004A



**HENRY&CO**

2500

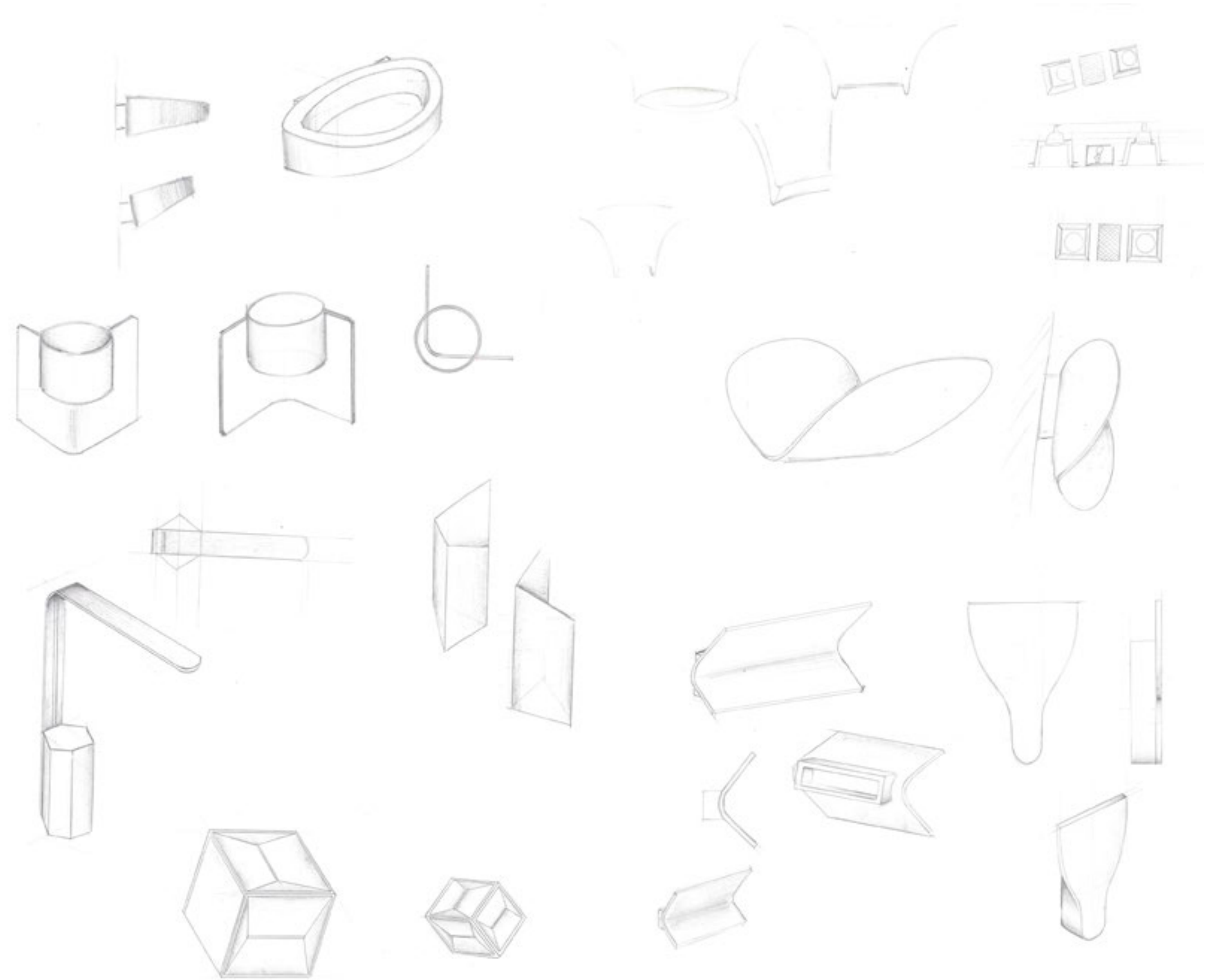

# INDICE ANALITICO

Analytical Index / Analytische Index / Index analytique

1090	p. 391	2427B	p. 89	NEW 2508G	p. 55	4039B	p. 247	4189C	p. 323	NEW 4248A	p. 188
1091	p. 391	2429B	p. 89	NEW 2508H	p. 55	4040B	p. 247	4189K	p. 322	NEW 4248E	p. 194
1092	p. 391	2436	p. 27	NEW 2509	p. 71	4042	p. 160	4190A	p. 325	NEW 4248F	p. 195
1093	p. 393	NEW 2438	p. 91	NEW 2511	p. 73	4044B	p. 161	4190B	p. 325	NEW 4249A	p. 189
1093B	p. 393	2443A	p. 95	NEW 2516A	p. 120	4045B	p. 249	4190C	p. 325	NEW 4249E	p. 196
1094	p. 391	2443B	p. 95	NEW 2516C	p. 120	4045C	p. 249	4190K	p. 324	NEW 4249F	p. 197
2012	p. 61	2443C	p. 95	NEW 2516D	p. 120	4046	p. 251	4191C	p. 175	NEW 4250A	p. 189
2013	p. 61	2443D	p. 95	NEW 2516F	p. 121	4052	p. 255	4191F	p. 175	NEW 4250E	p. 201
2014	p. 61	2446	p. 27	NEW 2516M	p. 121	4053	p. 255	4191I	p. 175	NEW 4251A	p. 204
2018	p. 63	NEW 2446B	p. 27	NEW 2516Q	p. 121	4054	p. 255	4191K	p. 176	NEW 4252A	p. 205
2019	p. 63	2452	p. 107	2536	p. 125	4058	p. 297	4191X	p. 176	4275	p. 273
2020	p. 63	2453	p. 107	2537	p. 125	4062	p. 297	4191Y	p. 177	4276	p. 273
2139	p. 65	2455	p. 109	2541	p. 125	4099	p. 297	4192I	p. 177	4277	p. 275
2184	p. 67	2456	p. 111	2546	p. 107	4100E	p. 299	4192K	p. 177	4278	p. 275
2293	p. 69	2457	p. 109	2547	p. 107	4100F	p. 299	4193	p. 289	4280	p. 277
2304	p. 71	2458	p. 111	2601A	p. 77	4100G	p. 299	4193B	p. 291	4281	p. 277
NEW 2304B	p. 71	NEW 2466B	p. 37	2602A	p. 79	4105	p. 251	NEW 4193F	p. 293	NEW 5289A	p. 384
2336	p. 73	2474	p. 91	2603A	p. 127	4110	p. 165	NEW 4193G	p. 293	NEW 5289B	p. 384
2336B	p. 73	2483A	p. 113	2603B	p. 127	4111	p. 165	4194	p. 289	NEW 5290	p. 385
2340	p. 81	2483B	p. 113	2604B	p. 127	4112	p. 306	4194B	p. 291	NEW 5291	p. 385
2365B	p. 21	2484A	p. 41	2608B	p. 127	4113	p. 167	4195A	p. 311	5503A	p. 373
NEW 2365E	p. 21	2484B	p. 41	2613B	p. 129	4113B	p. 169	4195B	p. 311	5503B	p. 373
NEW 2365G	p. 21	2484C	p. 41	2614B	p. 129	4114	p. 173	NEW 4195C	p. 313	5505A	p. 378
2369A	p. 23	2485A	p. 45	2615A	p. 129	4118	p. 167	NEW 4195D	p. 313	5505B	p. 379
2371A	p. 23	2485B	p. 45	2618	p. 37	4118B	p. 169	4196D	p. 179	5505C	p. 379
NEW 2372B	p. 26	2485C	p. 45	2619	p. 37	4122	p. 173	4196H	p. 179	5505D	p. 379
2388	p. 77	2486A	p. 47	2623C	p. 131	4130A	p. 303	4196N	p. 179	5505E	p. 379
2393	p. 23	2486B	p. 47	2623D	p. 131	4130B	p. 303	NEW 4197A	p. 181	5505F	p. 223
2396	p. 79	2486C	p. 48	2623T	p. 384	4130C	p. 303	NEW 4197B	p. 181	5507A	p. 374
2398	p. 81	2486D	p. 49	NEW 2630A	p. 97	4154B	p. 305	NEW 4197C	p. 181	5507B	p. 375
2402F	p. 25	2486E	p. 49	NEW 2630B	p. 97	4155B	p. 305	4198	p. 315	5507C	p. 375
2402G	p. 25	2486F	p. 49	NEW 2630C	p. 97	4156	p. 305	4199	p. 307	5507G	p. 221
2414B	p. 31	2489A	p. 113	NEW 2630D	p. 97	4160	p. 304	4201	p. 315	5507H	p. 221
2415B	p. 31	2489B	p. 113	NEW 2632A	p. 99	4164	p. 307	4202	p. 315	5507I	p. 221
2416A	p. 33	2493A	p. 115	NEW 2632B	p. 99	4167	p. 307	4204B	p. 315	5508A	p. 381
2416B	p. 33	2493B	p. 115	NEW 2632C	p. 99	4174	p. 259	NEW 4205A	p. 319	5508B	p. 381
2416C	p. 33	2493C	p. 115	NEW 2632D	p. 99	4175	p. 259	NEW 4205B	p. 319	NEW 5509	p. 377
NEW 2416D	p. 35	2493D	p. 115	NEW 2634A	p. 101	4176	p. 259	NEW 4205C	p. 319	NEW 5510A	p. 377
NEW 2416E	p. 35	2495	p. 109	NEW 2634B	p. 101	4177	p. 161	4210	p. 267	NEW 5510B	p. 377
2417	p. 31	NEW 2496	p. 77	NEW 2634C	p. 101	4178	p. 261	4215	p. 269	7156	p. 133
2419A	p. 81	NEW 2497	p. 91	NEW 2634D	p. 101	4179	p. 261	4216	p. 269	7157	p. 133
2421B	p. 84	NEW 2498	p. 116	NEW 2635A	p. 103	4180	p. 265	4218	p. 271	7305	p. 133
2421C	p. 85	NEW 2500	p. 117	NEW 2635B	p. 103	4180A	p. 265	4218A	p. 271	7310	p. 133
2421D	p. 85	NEW 2503	p. 117	NEW 2635C	p. 103	4180B	p. 265	4219	p. 271	7576	p. 135
2422B	p. 87	NEW 2504	p. 117	NEW 2635D	p. 103	4181	p. 267	NEW 4246A	p. 185	7577	p. 135
2423B	p. 87	NEW 2508A	p. 53	NEW 2636A	p. 105	4183	p. 267	NEW 4246C	p. 185	7578	p. 135
2426A	p. 281	NEW 2508B	p. 53	NEW 2636B	p. 105	4184	p. 261	NEW 4246E	p. 185	7946	p. 137
2426B	p. 281	NEW 2508C	p. 53	NEW 2636C	p. 105	4189A	p. 323	NEW 4247A	p. 188	7949	p. 137
2426C	p. 281	NEW 2508F	55	NEW 2636D	p. 105	4189B	p. 323	NEW 4247E	p. 193	7958	p. 65



8042	p. 139	8914A	p. 233	P001C	p. 331
8056	p. 139	8914B	p. 233	P001D	p. 331
8144	p. 139	8914C	p. 233	P002B	p. 333
8215	p. 137	8914D	p. 236	P002C	p. 333
8216	p. 141	NEW 8914E	p. 236	P002D	p. 333
8235	p. 143	8914Q	p. 236	P003B	p. 335
8254	p. 141	NEW 8916E	p. 237	P003C	p. 335
8259	p. 137	8917	p. 214	P003D	p. 335
8284	p. 145	8935A	p. 207	P004B	p. 337
8285	p. 151	8935B	p. 207	P004C	p. 337
8336	p. 147	8935C	p. 207	P004D	p. 337
8337	p. 147	8935D	p. 209	P005B	p. 339
8338	p. 147	8935G	p. 210	P005C	p. 339
8342	p. 69	8935H	p. 211	P005D	p. 339
8382	p. 145	8935I	p. 211	P007B	p. 341
8411	p. 143	8935L	p. 211	P007C	p. 341
8418	p. 67	8935M	p. 209	P007D	p. 341
8428	p. 149	8936A	p. 213	P009B	p. 345
8429	p. 151	8936B	p. 213	P009C	p. 345
8430	p. 151	8937A	p. 215	P009D	p. 345
8431	p. 151	8937B	p. 215	NEW P010B	p. 347
8459	p. 153	8943D	p. 239	NEW P010C	p. 347
8481	p. 153	8943H	p. 239	NEW P010D	p. 347
8672	p. 155	8943N	p. 239	NEW P011B	p. 349
8672B	p. 155	8943O	p. 239	NEW P011C	p. 349
8673	p. 155	8949A	p. 240	NEW P011D	p. 349
8673B	p. 155	8949B	p. 241	NEW P012B	p. 351
8759	p. 157	8949C	p. 241	NEW P012C	p. 351
8760	p. 157	8952A	p. 242	NEW P012D	p. 351
8879	p. 285	8952B	p. 243	NEW P013B	p. 353
8881	p. 285	8952C	p. 243	NEW P013C	p. 353
8882	p. 285	8956A	p. 327	NEW P013D	p. 353
8883	p. 285	8956B	p. 327	NEW P015B	p. 355
8895	p. 225	8956C	p. 327	NEW P015C	p. 355
8897	p. 227	NEW 8956D	p. 329	NEW P015D	p. 355
8898	p. 229	NEW 8956E	p. 329		
8899	p. 227	NEW 8956F	p. 329		
8900	p. 229	8956K	p. 326		
8903A	p. 231	9207	p. 149		
8903B	p. 231	M001C	p. 361		
8903C	p. 231	M002B	p. 361		
NEW 8903E	p. 231	M003B	p. 363		
8904A	p. 232	M004A	p. 363		
NEW 8904B	p. 232	M005	p. 367		
8909	p. 227	M006	p. 367		
8910	p. 229	M900A	p. 368		
8911	p. 227	M900B	p. 368		
8912	p. 229	M900C	p. 368		
NEW 8913	p. 232	P001B	p. 331		

Indice generale / General Index / Allgemeiner Index / Indice général .....	p. 2
Azienda / Company / Unternehmen / Entreprise .....	p. 4
Materiali / Materials / Materialien / Matériaux .....	p. 8
Finiture / Finishes / Ausführungen / Finitions .....	p. 12
Esempio Lettura Pagina Catalogo / Example catalogue page / Angaben für das Lesen der Katalogseite / Informations pour lire la page du catalogue .....	p. 16
Indice di sezione / Section index: Incasso a parete / Wall recessed lighting / Wand-Einbauleuchten / Encastrés muraux .....	p. 18
Indice di sezione / Section index: A parete / Wall lighting / Wandleuchten / Appliques .....	p. 56
Indice di sezione / Section index: Incasso a plafone / Ceiling recessed lighting / Decken-Einbauleuchten / Encastrés plafonds .....	p. 158
Indice di sezione / Section index: A plafone / Ceiling lighting / Deckenleuchten / Plafonniers .....	p. 218
Indice di sezione / Section index: Incasso a plafone e a parete / Ceiling and wall recessed lighting / Wand- und Decken-Einbauleuchten / Encastrés muraux et plafonds .....	p. 244
Indice di sezione / Section index: A plafone e a parete / Ceiling and Wall lighting / Decken- und Wandleuchten / Plafonniers et appliques .....	p. 278
Indice di sezione / Section index: Incasso 15mm / 15mm recessed lighting / 15 mm Einbauleuchten / Encastrés 15 mm .....	p. 286
Indice di sezione / Section index: Segnapassi / Pathmarkers / Orientierungsbeleuchtung / Balisages encastrés .....	p. 295
Indice di sezione / Section index: Profili / Profiles / Profile / Profilés .....	p. 320
Indice di sezione / Section index: Sistema audio SONORE® / SONORE® audio system / SONORE®-Audiosystem / Système audio SONORE® .....	p. 356
Indice di sezione / Section index: Sospensioni / Hanging lamps / Pendelleuchten / Suspensions .....	p. 370
Indice di sezione / Section index: Lampade da tavolo / Table lamps / Tischleuchten / Lampe de table .....	p. 382
Indice di sezione / Section index: Esterno / Outdoor Lamps / Aussenleuchten / Lampes d'extérieur .....	p. 388
Indice di sezione / Section index: Lampadine e strip LED / Strip LED and bulbs / LED Bänder und leuchtmittel / Ruban LED et ampoules .....	p. 394
Kit LED .....	p. 402
Alimentazione / Power supply / Betriebsgerät / Alimentation .....	p. 404
Casambi .....	p. 410
Bianco dinamico / Tunable White / Dynamisches Weiss / Blanc dynamique .....	p. 414
Emergency kit .....	p. 416
Sistemi di incasso / Installation systems / Einbausysteme / Système de montage .....	p. 420
Sistema multitaglia / Multi-size system .....	p. 421
CASSAFORMA per calcestruzzo / laterizio / HOUSING BOX for concrete / brickwork / EINBAUGEHÄUSE für Betonwand / Mauer / BOÎTIER ENCASTREMENT pour béton / briques .....	p. 422
Installazione profili / Installation profiles / Einbau profile / Installation profilés .....	p. 424
Designer .....	p. 428

# LEGENDA DEI SIMBOLI

## Legend of symbols

### INFORMAZIONI DI CARATTERE GENERALE

Tutti i prodotti 9010, fatto salvo i prodotti con LED incluso, sono forniti senza lampadina.

Fornitura dell'alimentatore:

parti elettriche GU5.3/GU4/ G53: l'alimentatore non è incluso nella fornitura.

prodotti 9010 con LED incluso: sono disponibili alimentatori con varia potenza secondo le indicazioni riportate nella pagina di ogni articolo.

La garanzia dei prodotti 9010 con LED decade con utilizzo di alimentatori non forniti da 9010 e/o in caso di inosservanza delle istruzioni di collegamento.

Le etichette energetiche sono disponibili su richiesta o scaricabili dal sito [www.9010.it](http://www.9010.it).

I cataloghi e la documentazione tecnica completa sono disponibili su richiesta o scaricabili dal sito [www.9010.it](http://www.9010.it).

I dati fotometrici sono disponibili su richiesta o scaricabili dal sito [www.9010.it](http://www.9010.it)

Tutti i prodotti sono conformi alle direttive CE. Valutazioni tecniche sulle certificazioni di sicurezza sono disponibili su richiesta.

Rivolgersi a personale qualificato per il collegamento. Eseguire una prova accurata del collegamento dell'alimentazione del dispositivo a LED, prima di eseguire la stuccatura finale degli spot.

Belfiore Srl si riserva la facoltà di apportare variazioni di dati caratteristici, materiali, design, stili, tonalità, senza alcun preavviso.

I Marchi 9010®, CRISTALY9010®, ALUMITE9010®, CONTRETE9010®, SONORE9010® sono di proprietà di Belfiore Srl.

### GENERAL INFORMATION

All 9010 products are delivered without bulb, except for products having LED included.

Power supply deliveries:

electrical parts GU5.3/GU4/ G53: the power supply is not included.

products with LED included: a wide range of power supplies are available, according to the indications in the catalogue page.

The warranty of 9010 LED products is not applicable in case of connection with Power Supplies that are not delivered by 9010 and/or in case of failure/non conformity with the mounting/connection instructions.

Energy Labels are available on demand or downloadable at [www.9010.it](http://www.9010.it).

Our catalogues and the technical documents are available on demand or downloadable at [www.9010.it](http://www.9010.it).

Photometric Data are available on demand or downloadable at [www.9010.it](http://www.9010.it).

All our products comply with CE Directives. Technical evaluations on safety certifications are available on demand.

Always contact qualified personnel for the wire connection. An accurate test of the electrical connection of the power supply with the LED device, has to be carried out before the final plaster and finish of the recessed light.

Belfiore Srl reserves the right to carry out variations to technical details, materials, design, style, colors with no previous notice.

The brands 9010®, CRISTALY9010®, ALUMITE9010®, CONTRETE9010®, SONORE9010® are registered trademarks of Belfiore Srl.

### ALLGEMEINE INFORMATIONEN

Alle Produkte 9010, mit Ausnahme jener inklusive LED, werden mit Leuchtmittelfassung aber ohne Leuchtmittel geliefert.

Lieferung des Betriebsgeräts:

Elektrische Teile GU5.3/GU4/G53 der Betriebsgeräte sind nicht im Lieferumfang enthalten.

Produkte 9010 inklusive LED: es sind Betriebsgeräte mit unterschiedlicher Leistung erhältlich, gemäß Angaben auf der Seite der einzelnen Artikel.

Die Garantie der Produkte 9010 mit LED verfällt, wenn sie nicht mit den für die Artikel 9010 gelieferten Betriebsgeräte verwendet bzw. die Anleitungen für den Anschluss missachtet werden.

Die Energieetiketten sind auf Anfrage verfügbar oder können von der Webseite [www.9010.it](http://www.9010.it) heruntergeladen werden.

Die Kataloge und die vollständigen technischen Unterlagen sind auf Anfrage verfügbar oder können von der Webseite [www.9010.it](http://www.9010.it) heruntergeladen werden.

Die fotometrischen Daten sind auf Anfrage verfügbar oder können von der Webseite [www.9010.it](http://www.9010.it) heruntergeladen werden.

Alle Produkte entsprechen den EG-Richtlinien. Technische Bewertungen der Sicherheitszertifikate sind auf Anfrage verfügbar. Wenden Sie sich für den Anschluss an qualifiziertes Personal. Vor dem endgültigen Verputzen der Einbauleuchten muss der korrekte Anschluss des Betriebsgeräts des LED-Elements sorgfältig kontrolliert werden.

Belfiore Srl behält sich das Recht vor ohne Voranmeldung Änderungen an den Werkstoffen, am Design, am Stil und an der Färbung vorzunehmen.

Die Marken 9010®, CRISTALY9010®, ALUMITE9010®, CONTRETE9010®, SONORE9010® sind Eigentum der Belfiore Srl.

### INFORMATIONS À CARACTÈRE GÉNÉRAL

Tous les produits 9010, à l'exception des produits avec LED incluse, sont fournis sans ampoule.

Fourniture de l'alimentation :

pièces électriques GU5.3/GU4/ G53 : l'alimentation n'est pas fournie

produits 9010 avec LED incluse : des alimentations avec différentes puissances sont disponibles, selon les indications sur la page de chaque article

La garantie des produits 9010 à LED expire en cas d'utilisation d'alimentations non fournies par 9010 ou en cas de non-respect des instructions de raccordement.

Les étiquettes-énergie sont disponibles sur demande ou peuvent être téléchargées depuis le site [www.9010.it](http://www.9010.it)

Les catalogues et la documentation technique complète sont disponibles sur demande ou peuvent être téléchargés depuis le site [www.9010.it](http://www.9010.it).

Les données photométriques sont disponibles sur demande ou peuvent être téléchargées depuis le site [www.9010.it](http://www.9010.it)

Tous les produits sont conformes aux directives CE. Les évaluations techniques sur les certifications de sécurité sont disponibles sur demande.

S'adresser à un personnel qualifié pour le raccordement. Effectuer un test du raccordement de l'alimentation du dispositif à LED avant d'effectuer lèenduite et peinture des produits encastrés.

Belfiore Srl se réserve le droit de modifier sans préavis les détails techniques, les matériaux, le design, le style et les couleurs.

Les marques 9010®, CRISTALY9010®, ALUMITE9010®, CONTRETE9010®, SONORE9010® appartiennent à Belfiore Srl.



**Contatto di terra / Classe I**  
Earth connector block / Class I  
Schutzklasse I / Schutzleiter  
Mise à la terre / Classe I



**Doppio isolamento / Classe II**  
Double insulation / Class II  
Schutzklasse II / Doppelisolierung  
Double isolement / Classe II



**Bassa tensione / Classe III**  
Safety extra-low voltage / Class III  
Schutzklasse III / Niedrige Spannungszuführung  
Alimentation à basse tension / Classe III



**Apparecchio conforme alle direttive della Comunità Europea**  
Appliance complying with E.E.C. regulation  
Das Gerät entspricht der EU Norm  
Appareil conforme aux normes Européennes



**Articolo ad incasso**  
Recessed article  
Einbauleuchte  
Article encastré



**Articolo non ad incasso**  
NOT recessed - wall/ceiling installation  
Nicht einbaufähige Leuchte - Wand/Decken Montage  
Non encastré - installation mur / plafond



**Articolo con alette regolabili**  
Article equipped with adjustable metal wings  
Leuchte mit einstellbaren Metallflügeln  
Article équipé d'ailettes métalliques réglables



**Articolo con sistema di manutenzione EASY MOUNTING SYSTEM**  
Article equipped with EASY MOUNTING SYSTEM maintenance system  
Leuchte mit EASY MOUNTING SYSTEM  
Article avec EASY MOUNTING SYSTEM



**Articolo che necessita di alimentatore in CORRENTE COSTANTE**  
Article with CONSTANT CURRENT power supply required  
Leuchte, die ein KONSTANTSTROM Betriebsgerät erfordert  
Article qui nécessite une alimentation en COURANT CONSTANT



**Articolo che necessita di alimentatore in TENSIONE COSTANTE**  
Article with CONSTANT TENSION power supply required  
Leuchte, die ein KONSTANTSPANNUNGS Betriebsgerät erfordert  
Article qui nécessite une ALIMENTATION TENSION constante



**Alimentatore nel controsoffitto**  
Power Supply in the counterceiling  
Betriebsgerät in der Zwischendecke  
Alimentation dans le faux plafond



**Alimentatore in scatola remota**  
Power Supply in remote box  
Betriebsgerät im Schaltkasten  
Alimentation déportée dans une boite



**Alimentatore in scatola remota**  
Power Supply in remote box  
Betriebsgerät im Schaltkasten  
Alimentation déportée dans une boite



**Alimentatore all'interno dell'applicue**  
Power Supply inside the wall lamp  
Betriebsgerät in der Wandleuchte  
Alimentation à l'intérieur de l'article



**Alimentatore incluso**  
Power Supply included  
inklusive Betriebsgerät  
Alimentation incluse



**Articolo tagliabile su misura**  
It can be cut to required size  
Es kann auf die gewünschte Länge geschnitten werden  
Il peut être coupé à la taille requise



IP20 / IP 44



IP 65

9010  
novantadieci®

**CONTACTS**

Via Contessa, 23  
36055 Nove VI - Italy  
Tel. +39 0424 590388  
Fax. +39 0424 829990

[www.9010.it](http://www.9010.it)

**Copywriter**

9010 novantadieci

**Printed**

Aprile 2019