

AMARCORDS



2022

# AMARCORDS

Coloro che vedono la luce prima degli altri sono condannati a continuare a dispetto degli altri, così Amarcords continua a fare con un catalogo rivoluzionario ma allo stesso tempo conservativo.

Le finiture restano sovrane di uno stile inconfondibile che sintetizza un connubio perfetto tra vintage, industrial e moderno.

Forme minimal e apparecchiature luminose versatili per qualsiasi tipo di esigenza, la maggior parte con lampadine e faretti sostituibili.

Dopo il grande successo dei binari trifase verniciati è arrivato il momento di scoprire la nuova gamma dei monofase, più piccoli e discreti.

La scoperta consiste nel vedere ciò che tutti hanno visto e nel pensare ciò che nessuno ha pensato.

Confermata la gamma storica dei componenti che hanno contribuito a costruire un brand ormai consolidato per il suo stile "amarcord", fortificato da un'acuta necessità di evoluzione.

Il cambiamento non può essere evitato.

Il cambiamento fornisce le opportunità per le innovazioni. Ti dà la possibilità di dimostrare la tua creatività.

Those who see the light before others are doomed to continue in spite of others and so Amarcords continues to do with a revolutionary but at the same time conservative catalog.

The finishings remain sovereign of an unmistakable style that synthesizes a perfect combination of vintage, industrial and modern.

Minimal shapes and versatile luminaires for any type of need, most with replaceable bulbs and spotlights.

After the great success of the painted three-phase tracks, discover the new range of single-phase, smaller and more discreet.

Discovery consists in seeing what everyone has seen and thinking what no one has thought.

The historical range of components that have contributed to building a well-established brand for its "amarcord" style fortified by an acute need for evolution has been confirmed. Change cannot be avoided.

Change provides opportunities for innovations.

It gives you the chance to show your creativity.

AMARCORDS



## INDICE INDEX

### CORPI ILLUMINANTI LIGHTING PRODUCTS

TOBE	6	TOBE
ORIENTABILI	8	ADJUSTABLES
BINARI	14	TRACKS
ORGANO	25	ORGANO
PLAFONIERE	36	CEILING LIGHTS
SOSPENSIONI	46	PENDANTS
APPLIQUE	52	APPLIQUES
QUBE	56	QUBE
ORGANO	57	ORGANO
PLAFONIERE	66	CEILING LIGHTS
APPLIQUE	71	APPLIQUES
SLIM	75	SLIM
APPLIQUE	76	APPLIQUES
PLAFONIERE	84	CEILING LIGHTS
SOSPENSIONI	90	PENDANTS
FLAT	97	FLAT
ELEMENTS	103	ELEMENTS
INDUSTRIAL	108	INDUSTRIAL
MARMO	109	MARMO
RUOTA	110	RUOTA
SAMPEI	112	SAMPEI
BELLS	114	BELLS
ROPE	115	ROPE
ROCKY PAPER	117	ROCKY PAPER

### COMPONENTI LIGHTING PRODUCTS

LAMPADINE	119	BULBS
CARBONIO	120	CARBON BULBS
LED DIMMERABILI	122	DIMMABLE LED BULBS
MASTERCHEF	126	KITCHEN BULBS
POWER LED	127	POWER LED BULBS
SMOKEY	128	SMOKEY BULBS
SMERIGLIATE	129	FROSTED BULBS
COLORED	130	COLORED BULBS
GERMAN TECHNOLOGY	131	GERMAN TECHNOLOGY
ELEMENTS	135	ELEMENTS
PORTALAMPADINE	141	LAMP HOLDERS
MARMO	145	MARBLE
PASTELLO	145	PASTEL
DECENTRATORI	146	WALL BRACKETS
DECENTRATORI PASTELLO	148	PASTEL WALL BRACKETS
FERMACAVI E SNODI	149	JOINTS AND CABLE CLAMP
ROSONI	150	CEILING ROSES
ROSONCINI PASTELLO	154	PASTEL CEILING ROSES
CAVI	155	CABLES
SETA	156	SILK
LARGA SEZIONE	158	LARGE SECTION
COLORI PASTELLO	159	PASTEL COLORS
LINO	160	LINEN
CANAPA	161	HEMP
JUTA	162	JUTE
COTONE	163	COTTON
PARALUMI	164	LAMP SHADES
GABBIE	166	CAGES
CAMPANE	168	BELLS
DISCHI	168	DISKS
PORCELLANA	170	PORCELAIN
GHIRLANDE	172	GUIRLANDES
FUNI	174	CORDS
ACCESSORI	176	ACCESSORIES
LAMPADINE-RICAMBIO	177	SPARE BULBS
PRODUZIONE	178	MANUFACTURING



## INDICE INCROCIATO CROSS INDEX

		BINARI TRACKS	INCASSI RECESSED	ROSONI CEILING ROSES	SOSPENSIONI PENDANTS	PLAFONIERA CEILING LIGHTS	APPLIQUE APPLIQUES
TOBE	SMILZO	26	26	26	26, 32		
	CRICCO	10,48	16,48	20,48	48	43	20,43,54
	CICCIO	12,28	18,28	22,34	28,34	38,44	22,40,44,53
	CICCIOE27	30	30	30	30		
	KIATTO	47	47	47	47	37	
QUBE	QUBINO	58	58	58	58		
	QUBETTO	60	60	60	60	68	72
	QUBOTTO					67	
SLIM	DANA						78
	LUNA						77
	FAVO				91	85	
	CARD				92	86	86
	POIS				93	88	88
	FLAT		98				
	ELEMENTS				104		
INDUSTRIAL	MARMO				109		
	RUOTA				111		
	SAMPEI						112
	BELLS				114		
	ROPE				115		
	ROCKYPAPER				116		



Forma e sostanza, eleganza con semplicità,  
linee morbide a pulite.  
Tutta la gamma Tobe rispetta le normative  
vigenti grazie alla possibilità di sostituire le  
lampadine lasciando quindi grande versatilità  
anche nella scelta di luce più idonea.  
Si scrive TOBE si legge TOBE  
Form and substance, elegance with simplicity,  
soft and clean lines.  
The whole Tobe range complies with the  
regulations in force thanks to the possibility  
of replacing the bulbs thus leaving great  
versatility even in the choice of the most  
suitable light.  
TOBE is written and TOBE is read

# TOBE

ORIENTABILI ADJUSTABLES

ORGANO

PLAFONIERE CEILING LIGHTS

SOSPENSIONI PENDANTS

APPLIQUE APPLIQUES



OPZIONE ZIGRINATO  
KNURLED OPTION  
-ZG



TOBE  
ORIENTABILI  
ADJUSTABLES

ORIENTABILE ADJUSTABLE  
CRICCO 6  
BINARIO TRACK

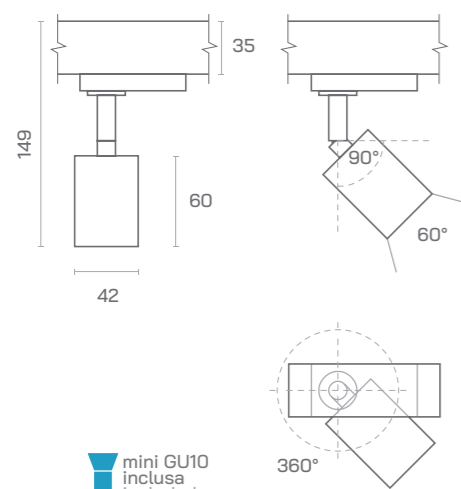

mini GU10  
inclusa  
included

TO480

FINITURE FINISHINGS

GALVANIZZATE  
GALVANIC

- OT  
ottone brass
- BZ  
brunzo bronze
- TI  
titanio titanium
- BR  
brunito burnished
- CF  
c. di fucile metalgun

GRAFITE  
GRAPHITE

- BI  
bianco white
- NE  
nero black
- CO  
corten corten

Faretto con lampadina a filo, binario trifase, temperatura colore 3000K  
Flat spotlight, triphase track, 3000K color temperature

unità di misura - unit of measurement: mm

BINARIO TRIFASE  
THREE-PHASE TRACK



OPZIONE  
BINARIO MONOFASE  
SINGLE PHASE TRACK  
OPTION

ORIENTABILE ADJUSTABLE  
CRICCO 13  
BINARIO TRACK

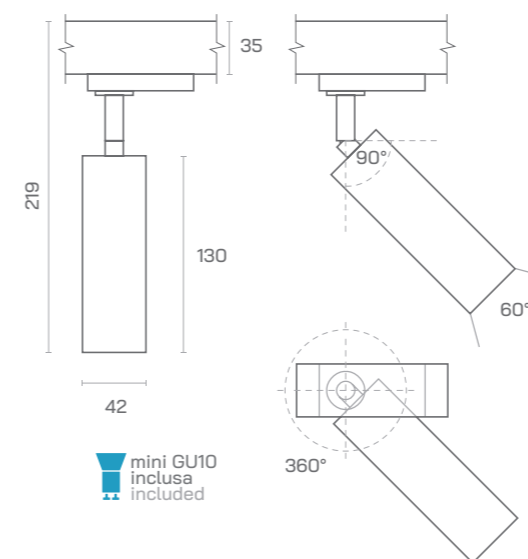

mini GU10  
inclusa  
included

TO481

FINITURE FINISHINGS

GALVANIZZATE  
GALVANIC

- OT  
ottone brass
- BZ  
brunzo bronze
- TI  
titanio titanium
- BR  
brunito burnished
- CF  
c. di fucile metalgun

GRAFITE  
GRAPHITE

- BI  
bianco white
- NE  
nero black
- CO  
corten corten

Faretto recesso, binario trifase, temperatura colore 3000K  
Recessed spotlight, triphase track, 3000K color temperature

unità di misura - unit of measurement: mm

BINARIO TRIFASE  
THREE-PHASE TRACK

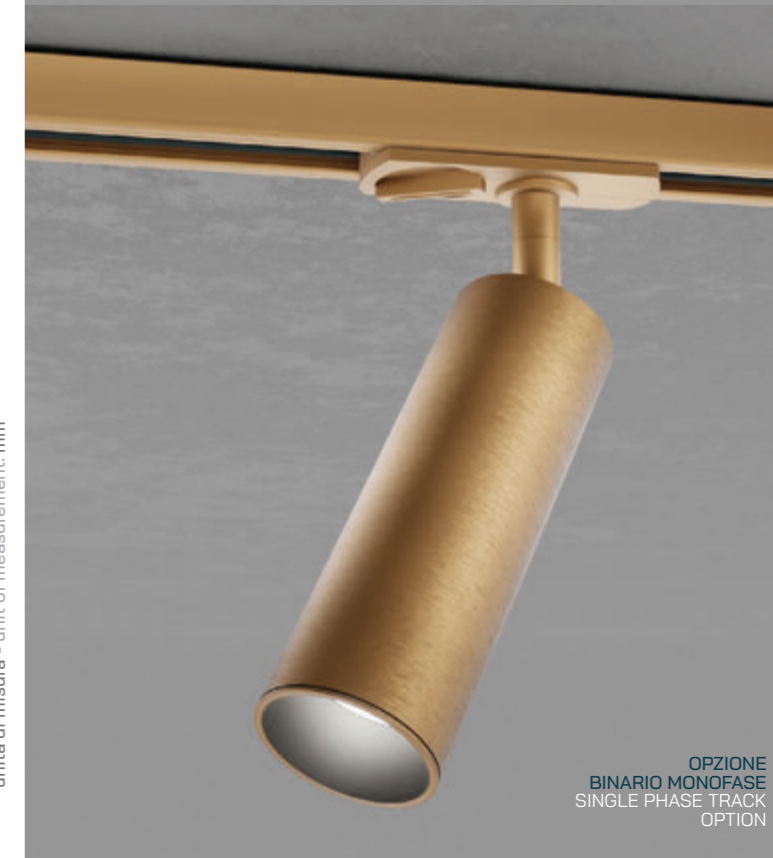

OPZIONE  
BINARIO MONOFASE  
SINGLE PHASE TRACK  
OPTION

OPZIONI OPTIONS

LAMPADINA  
BULB

- 2700K -MLC
- 4000K -MLF
- 3000K -MLN DEFAULT
- 4W - 220V - 300lm - CRI >90Ra

MONOFASE  
SINGLE PHASE -MF

ZIGRINATO  
KNURLED -ZG

SCEGLI LA TIGE  
CHOOSE YOUR ROD

- 10cm -TG10
- 15cm -TG15
- 20cm -TG20
- 30cm -TG30
- 40cm -TG40
- 45cm -TG45

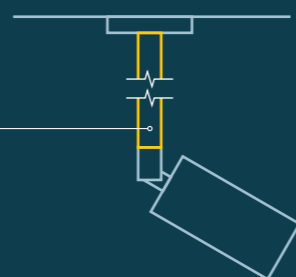

OPZIONI OPTIONS

LAMPADINA  
BULB

- 2700K -MLC
- 4000K -MLF
- 3000K -MLN DEFAULT
- 4W - 220V - 300lm - CRI >90Ra

MONOFASE  
SINGLE PHASE -MF

ZIGRINATO  
KNURLED -ZG

LAMPADINA A FILO  
FLAT -FL

SCEGLI LA TIGE  
CHOOSE YOUR ROD

- 10cm -TG10
- 15cm -TG15
- 20cm -TG20
- 30cm -TG30
- 40cm -TG40
- 45cm -TG45

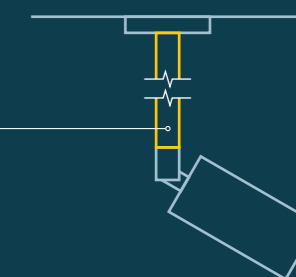

ORIENTABILE ADJUSTABLE  
CICCIO 8  
BINARIO TRACK

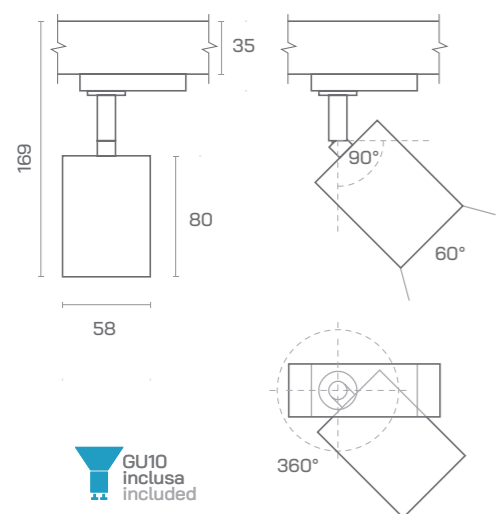

BINARIO TRIFASE  
THREE-PHASE TRACK



ORIENTABILE ADJUSTABLE  
CICCIO 13  
BINARIO TRACK

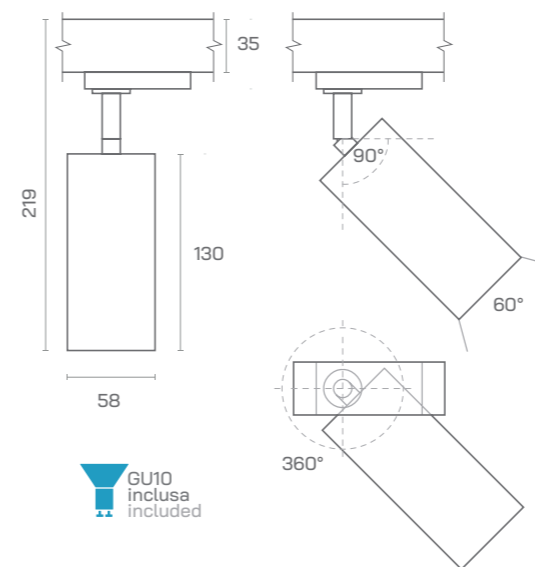

BINARIO TRIFASE  
THREE-PHASE TRACK



TO680

FINITURE FINISHINGS

GALVANIZZATE  
GALVANIC

- OT ottone brass
- BZ bronzo bronze
- TI titanio titanium
- BR brunito burnished
- CF c. di fucile metalgun

GRAFITE  
GRAPHITE

- BI bianco white
- NE nero black
- CO corten corten

Faretto con lampadina a filo, binario trifase, temperatura colore 3000K  
Flat spotlight, triphase track, 3000K color temperature

unità di misura - unit of measurement: mm



OPZIONE  
BINARIO MONOFASE  
SINGLE PHASE TRACK  
OPTION

TO681

FINITURE FINISHINGS

GALVANIZZATE  
GALVANIC

- OT ottone brass
- BZ bronzo bronze
- TI titanio titanium
- BR brunito burnished
- CF c. di fucile metalgun

GRAFITE  
GRAPHITE

- BI bianco white
- NE nero black
- CO corten corten

Faretto recesso, binario trifase, temperatura colore 3000K  
Recessed spotlight, triphase track, 3000K color temperature

unità di misura - unit of measurement: mm



OPZIONE  
BINARIO MONOFASE  
SINGLE PHASE TRACK  
OPTION

OPZIONI OPTIONS

LAMPADINA  
BULB

- 2700K -GLC
- 4000K -GLF
- 3000K -GLN DEFAULT
- 6W - 220V - 594lm - CRI >90Ra

MONOFASE  
SINGLE PHASE -MF

ZIGRINATO  
KNURLED -ZG

LAMPADINA RECESSA  
RECESSED BULB -RE

SCEGLI LA TIGE  
CHOOSE YOUR ROD

- 10cm -TG10
- 15cm -TG15
- 20cm -TG20
- 30cm -TG30
- 40cm -TG40
- 45cm -TG45

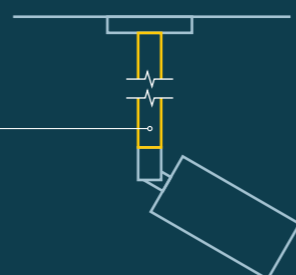

OPZIONI OPTIONS

MONOFASE  
SINGLE PHASE -MF

LAMPADINA A FILO  
FLAT -FL

LAMPADINA BULB

- 2700K -GLC
- 4000K -GLF
- 3000K -GLN DEFAULT
- 6W - 220V - 594lm - CRI >90Ra

- 2700K -GPC DIMMABLE
- 4000K -GPF SUPER POWER
- 3000K -GPN
- 12W - 220V - 950lm - CRI >90Ra

SCEGLI LA TIGE  
CHOOSE YOUR ROD

- 10cm -TG10
- 15cm -TG15
- 20cm -TG20
- 30cm -TG30
- 40cm -TG40
- 45cm -TG45

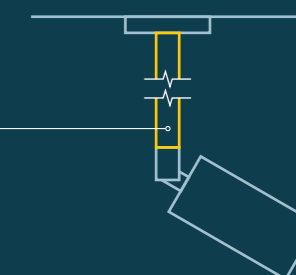

# BINARI TRIFASE THREE-PHASE TRACKS

Binario 220 Volt in alluminio eurotrack, 2m, ogni binario ha la testata per il collegamento elettrico e tappi inclusi. Il binario è studiato per semplificare lo spostamento dei faretti su di esso, ed è dotato di spessi conduttori in rame. I conduttori sono 4 e sono 3 fasi e un neutro, necessari a creare tre connessioni elettriche distinte e permettere tre accensioni differenti. In questo modo potrete accendere in modo differente i vari gruppi di fari LED collegati distintamente ad una delle tre fasi.

Three-phase track, 220 Volt aluminium eurotrack, 2m, every truck is completed with electrical connection plug and stoppers. The track is designed to simplify the movement of the spotlights on it, and is equipped with 4 copper conductors for 3 phases and a neutral, necessary to create three distinct electrical connections and allow three different ignitions. In this way you can switch on the various groups of LED lights separately connected to one of the three phases in a different way.



**ATD010**  
ottone  
brass

**ATD011**  
bronzo  
bronze

**ATD012**  
titanio  
titanium

**ATD016**  
brunito  
burnished

**ATD013**  
c. di fucile  
metalgun

**ATD014**  
bianco  
white

**ATD015**  
nero  
black

**ATD017**  
corten  
corten

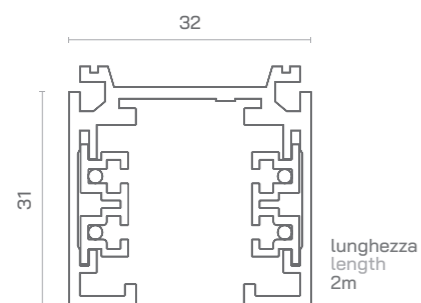

# BINARI MONOFASE SINGLE-PHASE TRACKS

Binario monofase 220 Volt in alluminio, 2m, ogni binario ha la testata per il collegamento elettrico e tappi inclusi. Il binario è studiato per semplificare lo spostamento dei faretti su di esso, ed è dotato di spessi conduttori in rame. Single-phase track, 220 Volt aluminium, 2m, every truck is completed with electrical connection plug and stoppers. The track is designed to simplify the movement of the spotlights on it.

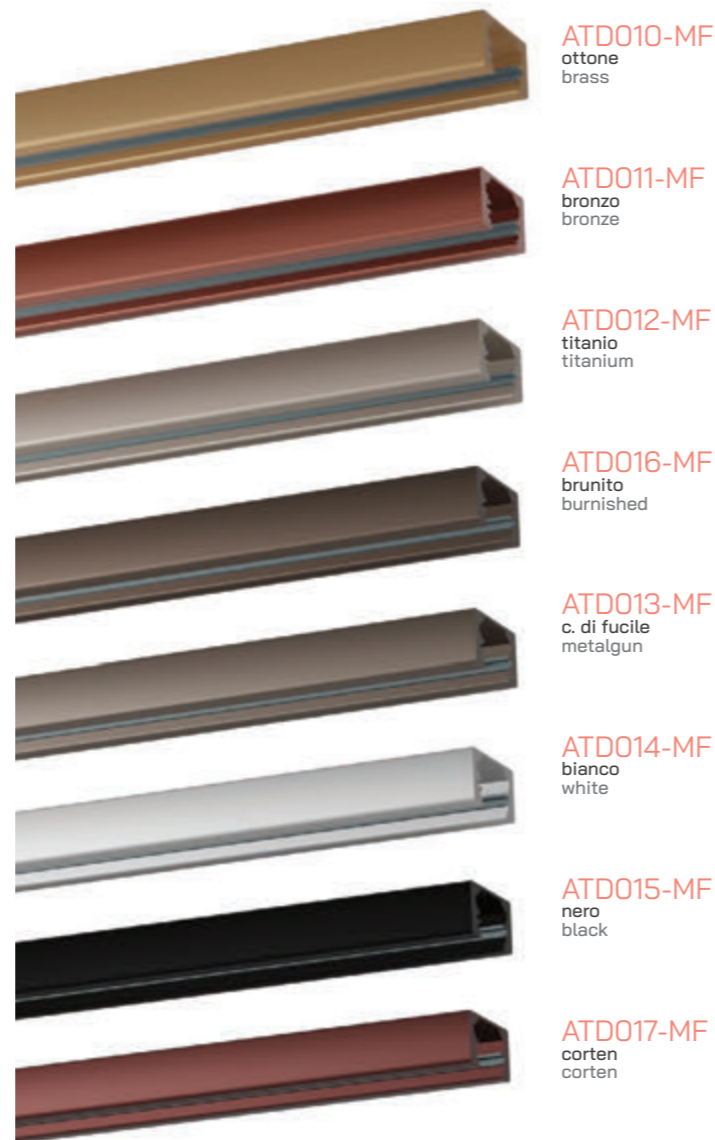

**ATD010-MF**  
ottone  
brass

**ATD011-MF**  
bronzo  
bronze

**ATD012-MF**  
titanio  
titanium

**ATD016-MF**  
brunito  
burnished

**ATD013-MF**  
c. di fucile  
metalgun

**ATD014-MF**  
bianco  
white

**ATD015-MF**  
nero  
black

**ATD017-MF**  
corten  
corten

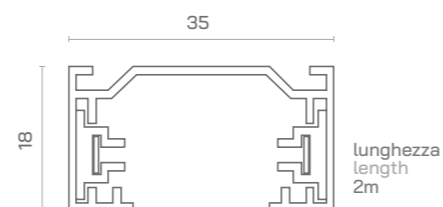

# GIUNTI PLUG



**I**  
Connettore diretto con alimentazione  
Carica massima 16A  
Direct connector with power supply  
Maximum charge 16A  
**ATD020** trifase three-phase  
**ATD020-MF** monofase single-phase

**B**  
Giunto conduttivo cieco per binari  
Blind conductive joint for tracks  
**ATD077** trifase three-phase  
**ATD077-MF** monofase single-phase

**F**  
Giunto flessibile per binari  
Raggio di curvatura 70°-180°  
Carica massima 16A  
Flexible coupling for tracks  
Radius of curvature 70°-180°  
Maximum charge 16A  
**AT079** trifase three-phase  
**AT079-MF** monofase single-phase

**LR**  
Connettore a L interno con alimentazione per binario  
Carica massima 16A  
Internal L connector with power supply for track  
Maximum charge 16A  
**ATD021** trifase three-phase  
**ATD021-MF** monofase single-phase

**LL**  
Connettore a L esterno con alimentazione per binario  
Carica massima 16A  
External L connector with power supply for track  
Maximum charge 16A  
**ATD090** trifase three-phase  
**ATD090-MF** monofase single-phase

**TR**  
Connettore a T destro con alimentazione per binario  
Carica massima 16A  
Right T connector with power supply for track  
Maximum charge 16A  
**ATD022** trifase three-phase  
**ATD022-MF** monofase single-phase

**TL**  
Connettore a T sinistro con alimentazione per binario  
Carica massima 16A  
Left T connector with power supply for track  
Maximum charge 16A  
**ATD091** trifase three-phase  
**ATD091-MF** monofase single-phase



**X**  
Connettore a X con alimentazione per binari  
Carica massima 16A  
X connector with power supply for tracks  
Maximum charge 16A  
**ATD023** trifase three-phase  
**ATD023-MF** monofase single-phase



**R**  
Alimentatore destro per binari  
Carica massima 16A  
Right power supply for tracks  
Maximum charge 16A  
**ATD075** trifase three-phase  
**ATD075-MF** monofase single-phase



**L**  
Alimentatore sinistro per binari. Carica massima 16A  
Left power supply for tracks. Maximum charge 16A  
**ATD074** trifase three-phase  
**ATD074-MF** monofase single-phase



**C**  
Copertura terminale per binari  
Terminal cover for tracks  
**ATD076** trifase three-phase  
**ATD076-MF** monofase single-phase

**S**  
Cavo di sospensione per binari completo di rosone  
Suspension cable for tracks complete with canopy  
**AT028** trifase three-phase  
**AT028-MF** monofase single-phase

## FINITURE FINISHINGS

-  -OT  
ottone brass
-  -BZ  
bronzo bronze
-  -TI  
titanio titanium
-  -BR  
brunito burnished
-  -CF  
c. di fucile metalgun
-  -BI  
bianco white
-  -NE  
nero black
-  -CO  
corten corten



ORIENTABILE ADJUSTABLE  
CRICCO 6  
INCASSO RECESSED

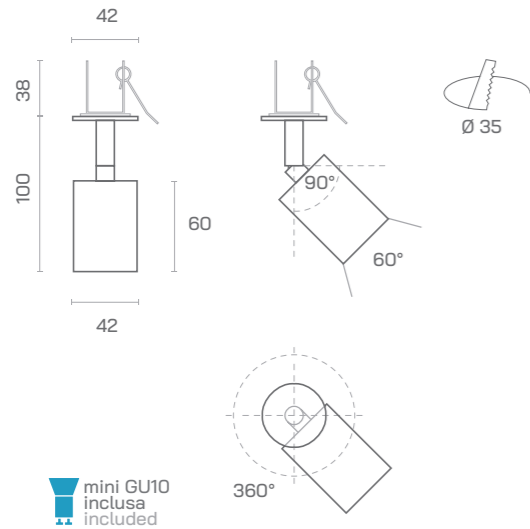

TO470

FINITURE FINISHINGS

GALVANIZZATE  
GALVANIC

-OT  
ottone brass

-BZ  
bronzo bronze

-TI  
titanio titanium

-BR  
brunito burnished

-CF  
c. di fucile metalgun

GRAFITE  
GRAPHITE

-BI  
bianco white

-NE  
nero black

-CO  
corten corten

Faretto con lampadina a filo, temperatura colore 3000K  
Flat spotlight, 3000K color temperature

unità di misura - unit of measurement: mm

ORIENTABILE ADJUSTABLE  
CRICCO 13  
INCASSO RECESSED

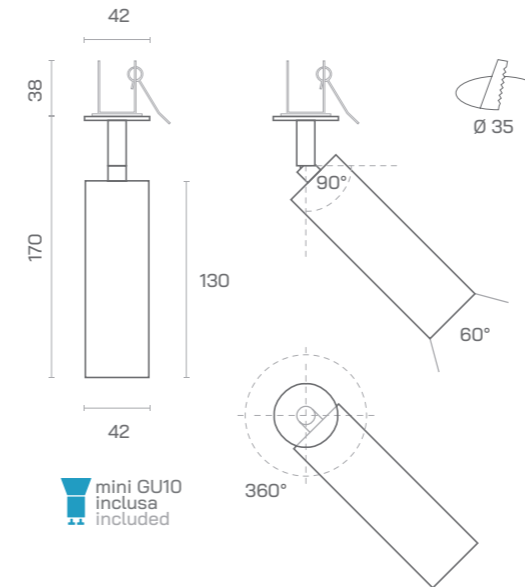

TO471

FINITURE FINISHINGS

GALVANIZZATE  
GALVANIC

-OT  
ottone brass

-BZ  
bronzo bronze

-TI  
titanio titanium

-BR  
brunito burnished

-CF  
c. di fucile metalgun

GRAFITE  
GRAPHITE

-BI  
bianco white

-NE  
nero black

-CO  
corten corten

Faretto recesso, temperatura colore 3000K  
Recessed spotlight, 3000K color temperature

unità di misura - unit of measurement: mm

OPZIONI OPTIONS

ZIGRINATO  
KNURLED -ZG

LAMPADINA  
BULB

2700K -MLC  
4000K -MLF  
3000K -MLN DEFAULT  
4W - 220V - 300lm - CRI >90Ra

SCEGLI LA TIGE  
CHOOSE YOUR ROD

10cm -TG10  
15cm -TG15  
20cm -TG20  
30cm -TG30  
40cm -TG40  
45cm -TG45

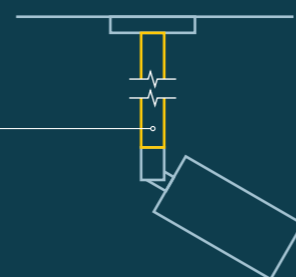

OPZIONI OPTIONS

ZIGRINATO  
KNURLED -ZG

LAMPADINA A FILO  
FLAT -FL

LAMPADINA  
BULB

2700K -MLC  
4000K -MLF  
3000K -MLN DEFAULT  
4W - 220V - 300lm - CRI >90Ra

SCEGLI LA TIGE  
CHOOSE YOUR ROD

10cm -TG10  
15cm -TG15  
20cm -TG20  
30cm -TG30  
40cm -TG40  
45cm -TG45

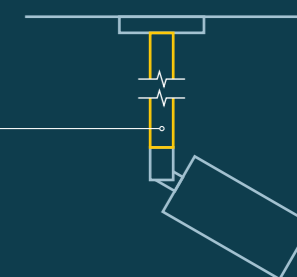



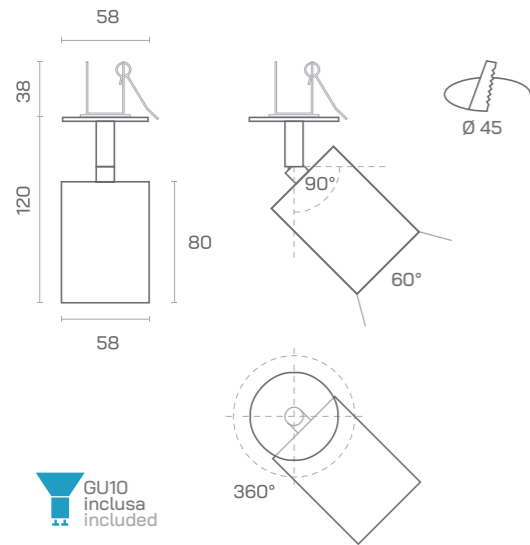

ORIENTABILE ADJUSTABLE  
CICCIO 8  
INCASSO RECESSED



TO670

FINITURE FINISHINGS

GALVANIZZATE  
GALVANIC

-  -OT  
ottone brass
-  -BZ  
bronzo bronze
-  -TI  
titanio titanium
-  -BR  
brunito burnished
-  -CF  
c. di fucile metalgun

GRAFITE  
GRAPHITE

-  -BI  
bianco white
-  -NE  
nero black
-  -CO  
corten corten

Faretto con lampadina a filo, temperatura colore 3000K  
Flat spotlight, 3000K color temperature

unità di misura - unit of measurement: mm

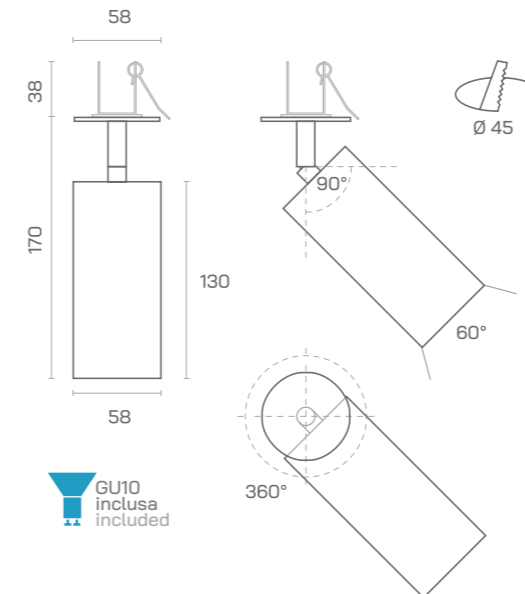

ORIENTABILE ADJUSTABLE  
CICCIO 13  
INCASSO RECESSED



TO671

FINITURE FINISHINGS

GALVANIZZATE  
GALVANIC

-  -OT  
ottone brass
-  -BZ  
bronzo bronze
-  -TI  
titanio titanium
-  -BR  
brunito burnished
-  -CF  
c. di fucile metalgun

GRAFITE  
GRAPHITE

-  -BI  
bianco white
-  -NE  
nero black
-  -CO  
corten corten

Faretto recesso, temperatura colore 3000K  
Recessed spotlight, 3000K color temperature

unità di misura - unit of measurement: mm

OPZIONI OPTIONS

ZIGRINATO  
KNURLED -ZG

LAMPADINA RECESSA  
RECESSED BULB -RE

LAMPADINA BULB

2700K -GLC  
4000K -GLF  
3000K -GLN DEFAULT  
6W - 220V - 594lm - CRI >90Ra

SCEGLI LA TIGE  
CHOOSE YOUR ROD

- 10cm -TG10
- 15cm -TG15
- 20cm -TG20
- 30cm -TG30
- 40cm -TG40
- 45cm -TG45

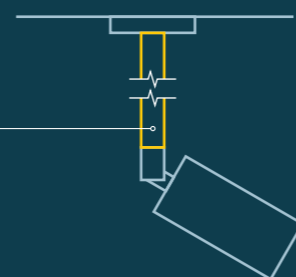

OPZIONI OPTIONS

LAMPADINA A FILO  
FLAT -FL

LAMPADINA BULB

2700K -GLC  
4000K -GLF  
3000K -GLN DEFAULT  
6W - 220V - 594lm - CRI >90Ra

2700K -GPC  
4000K -GPF  
3000K -GPN  
12W - 220V - 950lm - CRI >90Ra



SCEGLI LA TIGE  
CHOOSE YOUR ROD

- 10cm -TG10
- 15cm -TG15
- 20cm -TG20
- 30cm -TG30
- 40cm -TG40
- 45cm -TG45

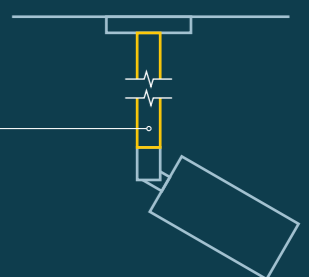

ORIENTABILE ADJUSTABLE  
CRICCO 6  
ROSONE CEILING ROSE

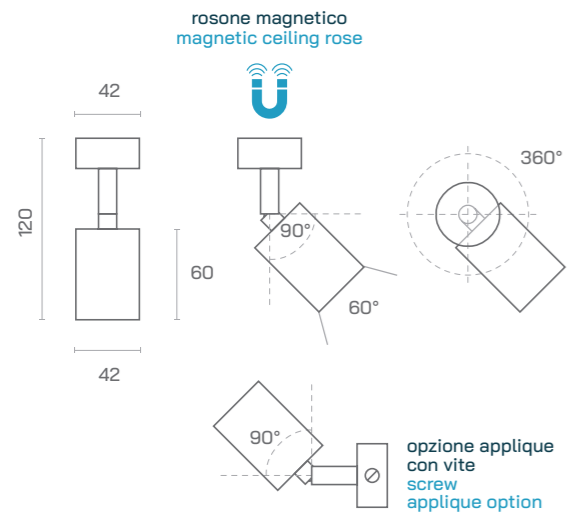

mini GU10  
inclusa  
included



TO410

FINITURE FINISHINGS

GALVANIZZATE  
GALVANIC

-OT  
ottone brass

-BZ  
bronzo bronze

-TI  
titanio titanium

-BR  
brunito burnished

-CF  
c. di fucile metalgun

GRAFITE  
GRAPHITE

-BI  
bianco white

-NE  
nero black

-CO  
corten corten

Faretto con lampadina a filo, colore 3000K, rosone magnetico  
Flat spotlight, 3000K color temperature, magnetic ceiling rose

unità di misura - unit of measurement: mm

ORIENTABILE ADJUSTABLE  
CRICCO 13  
ROSONE CEILING ROSE

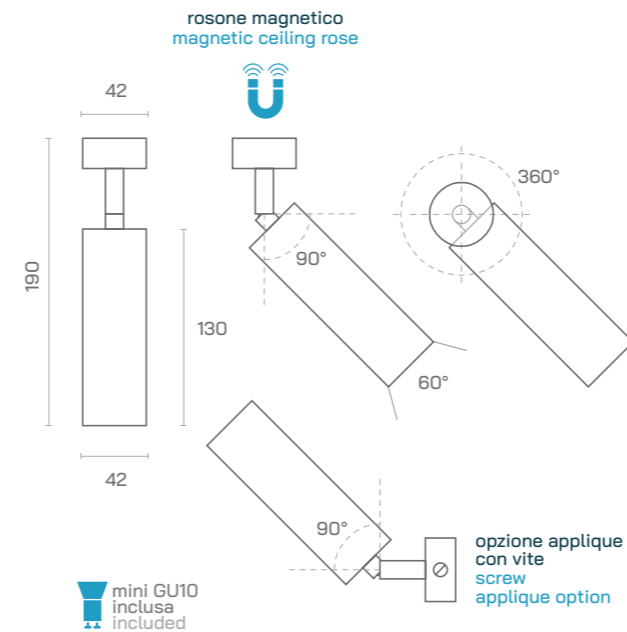

mini GU10  
inclusa  
included



TO411

FINITURE FINISHINGS

GALVANIZZATE  
GALVANIC

-OT  
ottone brass

-BZ  
bronzo bronze

-TI  
titanio titanium

-BR  
brunito burnished

-CF  
c. di fucile metalgun

GRAFITE  
GRAPHITE

-BI  
bianco white

-NE  
nero black

-CO  
corten corten

Faretto recesso, temperatura colore 3000K, rosone magnetico  
Recessed spotlight, 3000K color temperature, magnetic ceiling rose

unità di misura - unit of measurement: mm

OPZIONI OPTIONS

ZIGRINATO  
KNURLED -ZG

LAMPADINA  
BULB

2700K -MLC  
4000K -MLF  
3000K -MLN DEFAULT  
4W - 220V - 300lm - CRI >90Ra

APPLIQUE -AP

SCEGLI LA TIGE  
CHOOSE YOUR ROD

10cm -TG10  
15cm -TG15  
20cm -TG20  
30cm -TG30  
40cm -TG40  
45cm -TG45

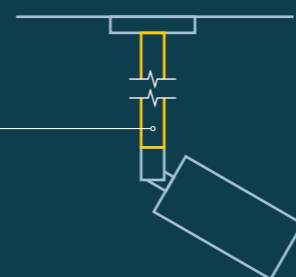

OPZIONI OPTIONS

ZIGRINATO  
KNURLED -ZG

LAMPADINA A FILO  
FLAT -FL

LAMPADINA  
BULB

2700K -MLC  
4000K -MLF  
3000K -MLN DEFAULT  
4W - 220V - 300lm - CRI >90Ra

APPLIQUE -AP

SCEGLI LA TIGE  
CHOOSE YOUR ROD

10cm -TG10  
15cm -TG15  
20cm -TG20  
30cm -TG30  
40cm -TG40  
45cm -TG45

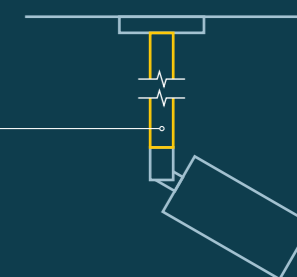

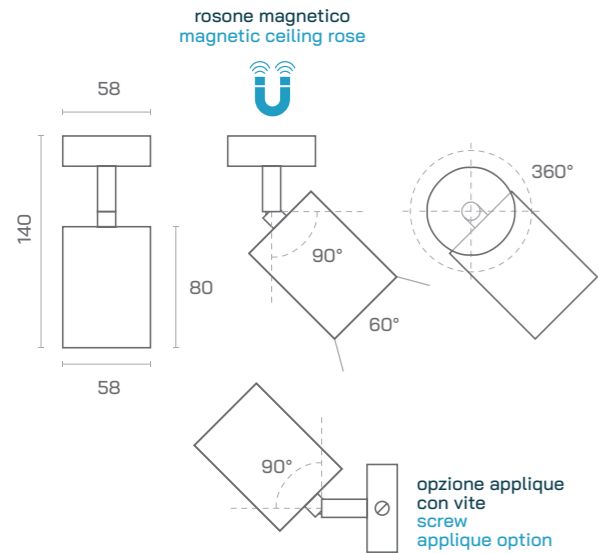

ORIENTABILE ADJUSTABLE  
CICCIO 8  
ROSONE CEILING ROSE



TO610

FINITURE FINISHINGS

GALVANIZZATE  
GALVANIC

-  -OT  
ottone brass
-  -BZ  
bronzo bronze
-  -TI  
titanio titanium
-  -BR  
brunito burnished
-  -CF  
c. di fucile metalgun

GRAFITE  
GRAPHITE

-  -BI  
bianco white
-  -NE  
nero black
-  -CO  
corten corten

Faretto con lampadina a filo, colore 3000K, rosone magnetico  
Flat spotlight, 3000K color temperature, magnetic ceiling rose

unità di misura - unit of measurement: mm



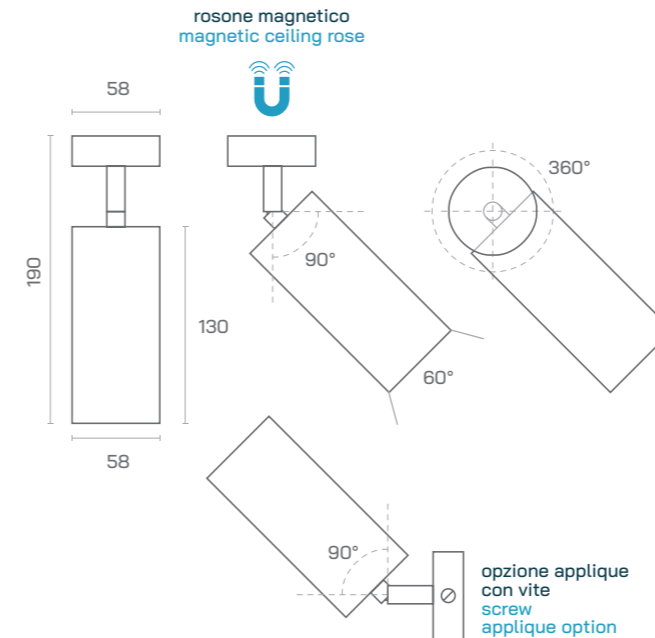

ORIENTABILE ADJUSTABLE  
CICCIO 13  
ROSONE CEILING ROSE



TO611

FINITURE FINISHINGS

GALVANIZZATE  
GALVANIC

-  -OT  
ottone brass
-  -BZ  
bronzo bronze
-  -TI  
titanio titanium
-  -BR  
brunito burnished
-  -CF  
c. di fucile metalgun

GRAFITE  
GRAPHITE

-  -BI  
bianco white
-  -NE  
nero black
-  -CO  
corten corten

Faretto recesso, temperatura colore 3000K, rosone magnetico  
Recessed spotlight, 3000K color temperature, magnetic ceiling

unità di misura - unit of measurement: mm



OPZIONI OPTIONS

ZIGRINATO  
KNURLED -ZG

LAMPADINA RECESSA  
RECESSED BULB -RE

LAMPADINA BULB

2700K -GLC  
4000K -GLF  
3000K -GLN DEFAULT  
6W - 220V - 594lm - CRI >90Ra

APPLIQUE -AP

SCEGLI LA TIGE  
CHOOSE YOUR ROD

- 10cm -TG10
- 15cm -TG15
- 20cm -TG20
- 30cm -TG30
- 40cm -TG40
- 45cm -TG45

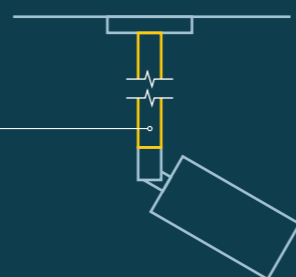

OPZIONI OPTIONS

LAMPADINA A FILO  
FLAT -FL

APPLIQUE -AP

LAMPADINA BULB

2700K -GLC  
4000K -GLF  
3000K -GLN DEFAULT  
6W - 220V - 594lm - CRI >90Ra

2700K -GPC  
4000K -GPF  
3000K -GPN  
12W - 220V - 950lm - CRI >90Ra

 DIMMABLE  
 SUPER POWER

SCEGLI LA TIGE  
CHOOSE YOUR ROD

- 10cm -TG10
- 15cm -TG15
- 20cm -TG20
- 30cm -TG30
- 40cm -TG40
- 45cm -TG45

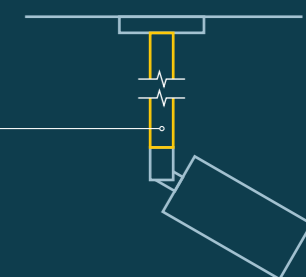



## TOBE ORGANO

La successione Fibonacci, secondo cui ogni altro numero è dato dalla somma dei due precedenti, trova espressione nelle geometrie e nelle armonie della serie Organo. Estrusi di alluminio affogati in bagni galvanici pronti a donare luminosità riflessa di luce propria. A sospensione nelle versioni a binario, con rosone o da incasso.

The Fibonacci sequence, according to which every other number is given by the sum of the two previous ones, finds expression in the geometries and harmonies of the Organ series. Aluminum extrusions drowned in galvanic baths ready to give reflected brightness of their own light. Suspended in track, with rose or recessed versions.

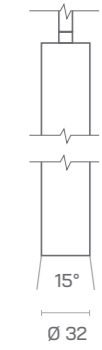
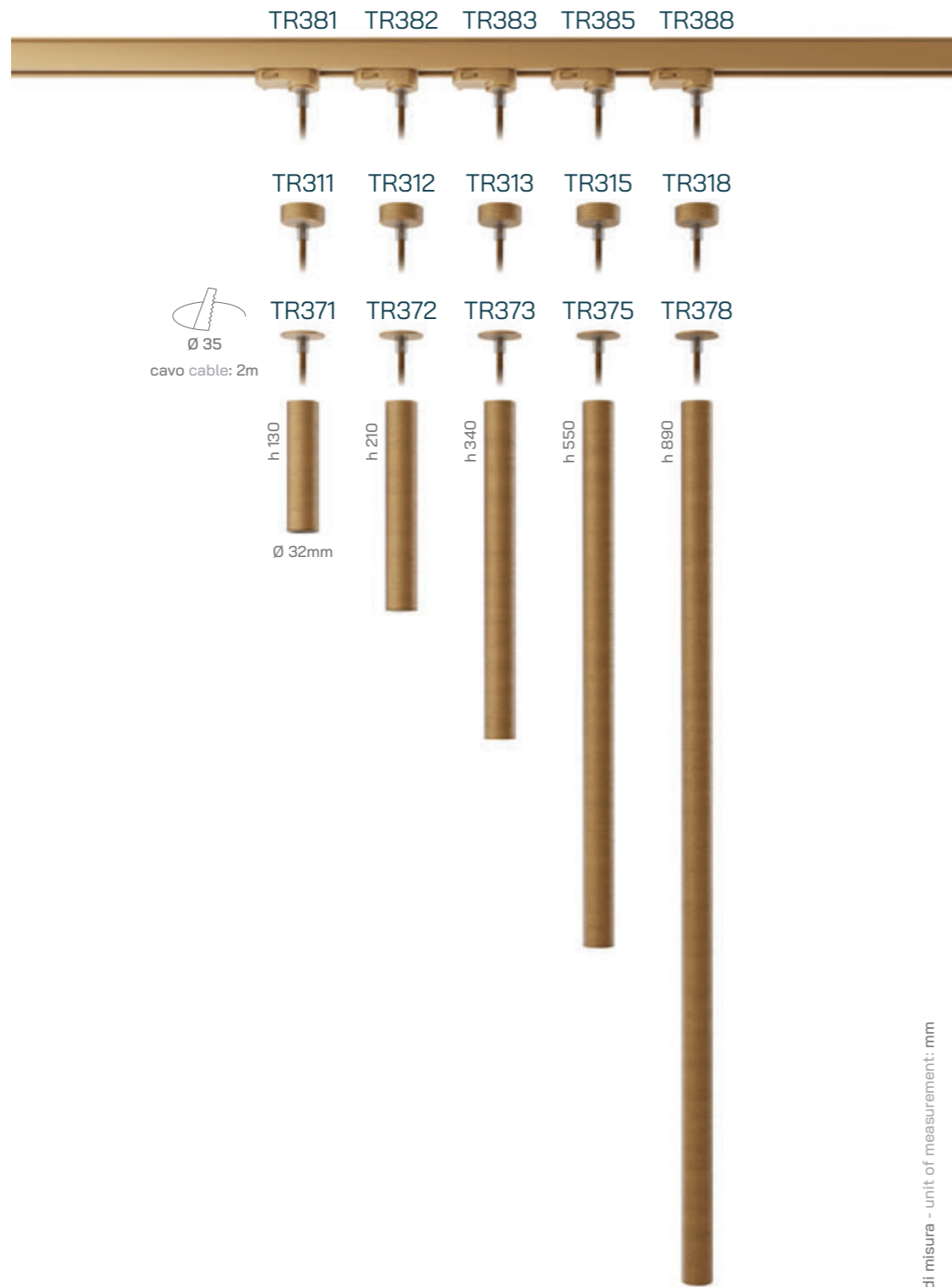

Ø 35  
cavo cable: 2m

h 130  
Ø 32mm

h 210

h 340

h 550

h 890

GU9  
inclusa  
included

#### FINITURE FINISHINGS

##### GALVANIZZATE GALVANIC

- OT  
ottone brass
- BZ  
bronzo bronze
- TI  
titanio titanium
- BR  
brunito burnished
- CF  
c. di fucile metalgun

##### GRAFITE GRAPHITE

- BI  
bianco white
- NE  
nero black
- CO  
corten corten

Faretto recesso, binario trifase, temperatura colore 3000K  
Recessed spotlight, triphase track, 3000K color temperature

unità di misura - unit of measurement: mm



#### OPZIONI OPTIONS

#### LAMPADINA BULB

4000K -9LF  
3000K -9LN DEFAULT  
4W - 220V - 400lm - CRI>90Ra

#### MONOFASE SINGLE PHASE

-MF

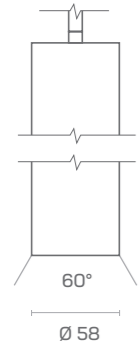

GU10  
inclusa  
included

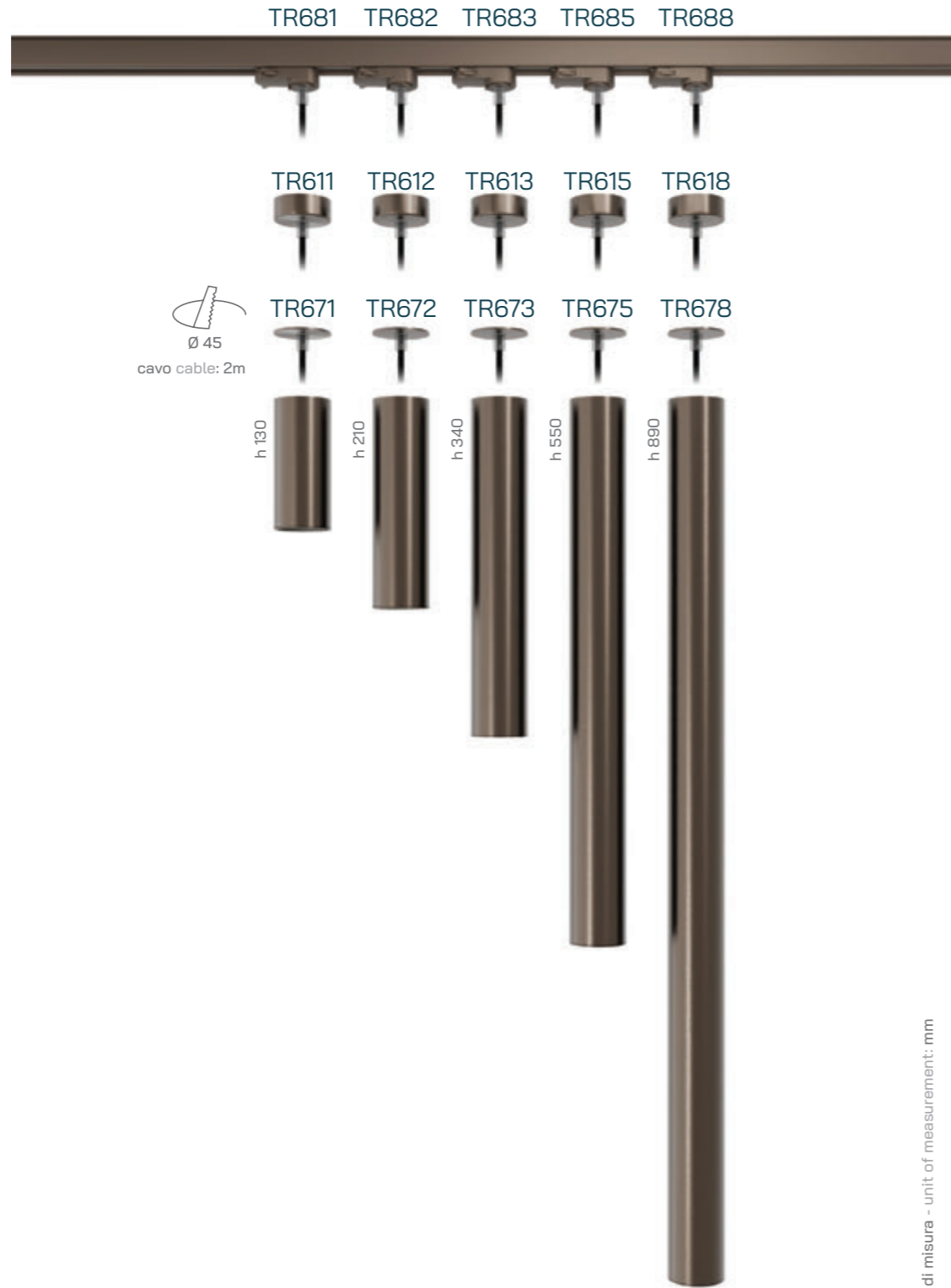

FINITURE FINISHINGS

GALVANIZZATE  
GALVANIC

- OT  
ottone brass
- BZ  
bronzo bronze
- TI  
titanio titanium
- BR  
brunito burnished
- CF  
c. di fucile metalgun

GRAFITE  
GRAPHITE

- BI  
bianco white
- NE  
nero black
- CO  
corten corten

Faretto recesso, binario trifase, temperatura colore 3000K  
Recessed spotlight, triphase track, 3000K color temperature

unità di misura - unit of measurement: mm



OPZIONI OPTIONS

LAMPADINA BULB

- 2700K -GLC
- 4000K -GLF
- 3000K -GLN DEFAULT
- 6W - 220V - 594lm - CRI >90Ra

- 2700K -GPC
  - 4000K -GPF
  - 3000K -GPN
  - 12W - 220V - 950lm - CRI >90Ra
- DIMMABLE  
 SUPER POWER

MONOFASE  
SINGLE PHASE

-MF

# ORGANO CICCIO E27

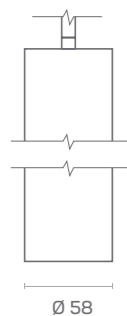

lampadina  
non inclusa  
bulb  
not included

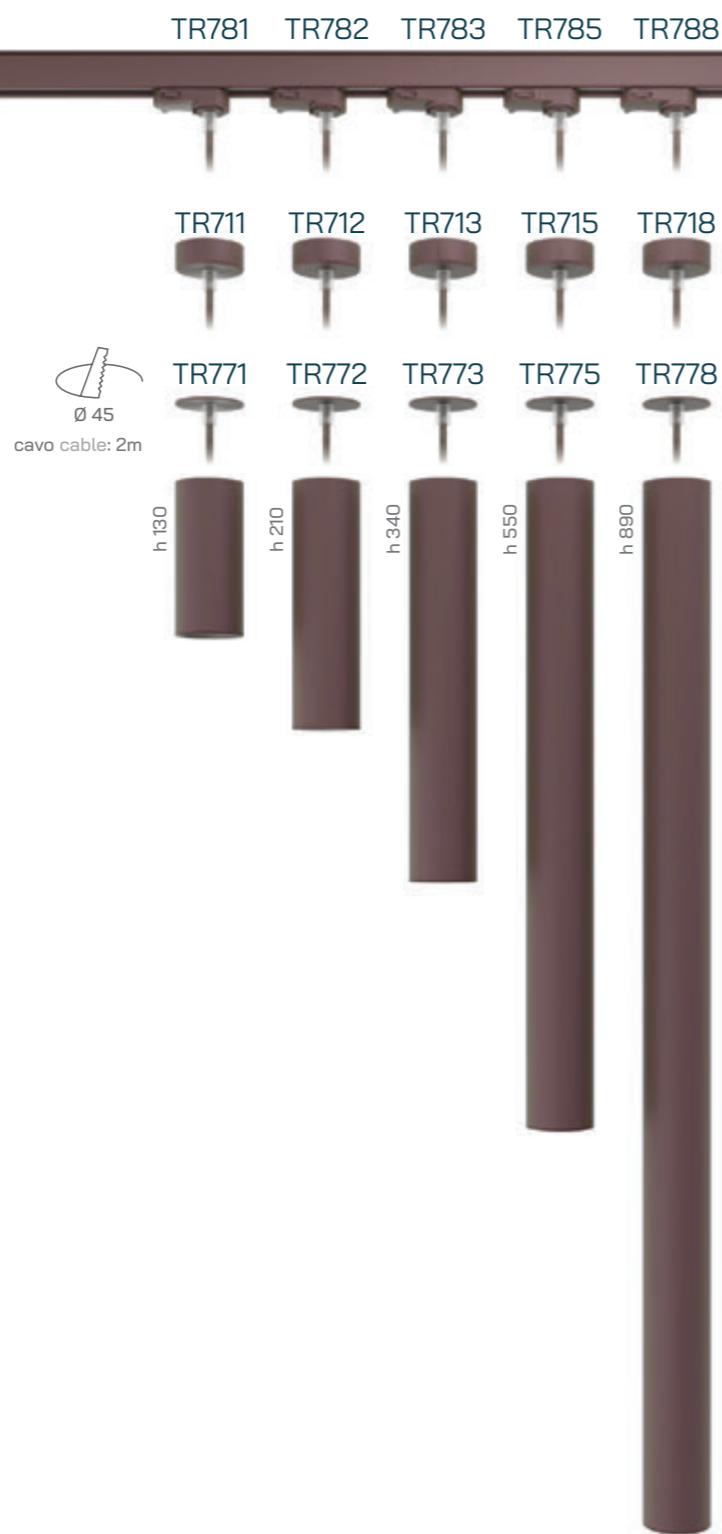

## FINITURE FINISHINGS

### GALVANIZZATE GALVANIC

- OT  
ottone *brass*
- BZ  
bronzo *bronze*
- TI  
titanio *titanium*
- BR  
brunito *burnished*
- CF  
c. di fucile *metalgun*

### GRAFITE GRAPHITE

- BI  
bianco *white*
- NE  
nero *black*
- CO  
corten *corten*

Faretto recesso, binario trifase, temperatura colore 3000K  
Recessed spotlight, triphase track, 3000K color temperature

unità di misura - unit of measurement: mm



## OPZIONI OPTIONS

MONOFASE  
SINGLE PHASE

-MF



ORGANO  
SMILZO 55x3  
ROSONE CEILING ROSE

rosone magnetico  
magnetic ceiling rose

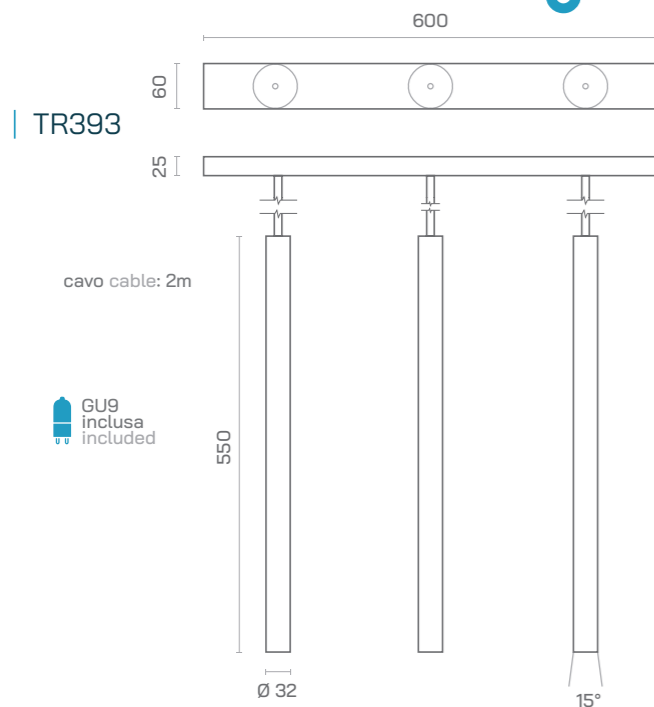

TR393

cavo cable: 2m

GUG9  
inclusa  
included

FINITURE FINISHINGS

GALVANIZZATE  
GALVANIC

-OT  
ottone brass

-BZ  
bronzo bronze

-TI  
titanio titanium

-BR  
brunito burnished

-CF  
c. di fucile metalgun

GRAFITE  
GRAPHITE

-BI  
bianco white

-NE  
nero black

-CO  
corten corten

Faretto recesso, temperatura colore 3000K,  
rosone magnetico  
Recessed spotlight, 3000K color  
temperature, magnetic ceiling rose

unità di misura - unit of measurement: mm



OPZIONI OPTIONS

LAMPADINA  
BULB

4000K -9LF  
3000K -9LN DEFAULT  
4W - 220V - 400lm - CRI>90Ra

ORGANO  
SMILZO x4  
ROSONE CEILING ROSE

rosone magnetico  
magnetic ceiling rose

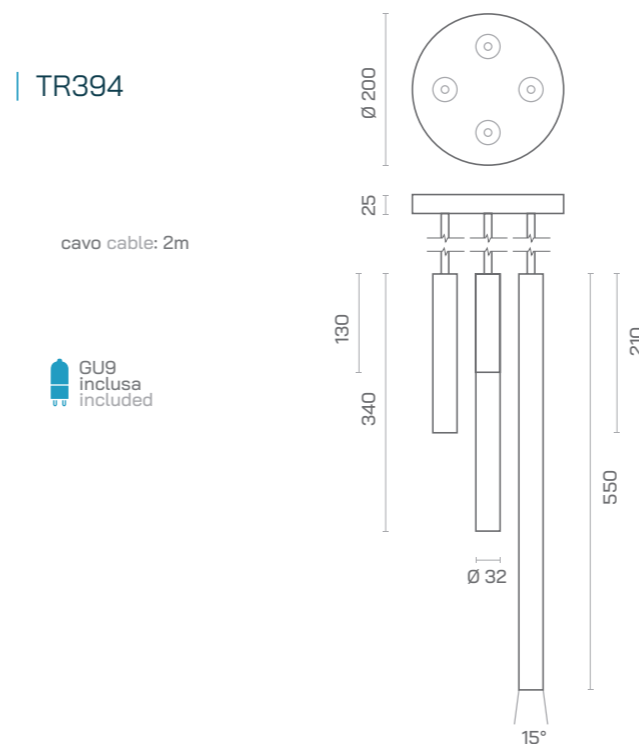

TR394

cavo cable: 2m

GUG9  
inclusa  
included

FINITURE FINISHINGS

GALVANIZZATE  
GALVANIC

-OT  
ottone brass

-BZ  
bronzo bronze

-TI  
titanio titanium

-BR  
brunito burnished

-CF  
c. di fucile metalgun

GRAFITE  
GRAPHITE

-BI  
bianco white

-NE  
nero black

-CO  
corten corten

Faretto recesso, temperatura colore 3000K,  
rosone magnetico  
Recessed spotlight, 3000K color  
temperature, magnetic ceiling rose

unità di misura - unit of measurement: mm



OPZIONI OPTIONS

LAMPADINA  
BULB

4000K -9LF  
3000K -9LN DEFAULT  
4W - 220V - 400lm - CRI>90Ra

ORGANO  
CICCIO 55x3  
ROSONE CEILING ROSE

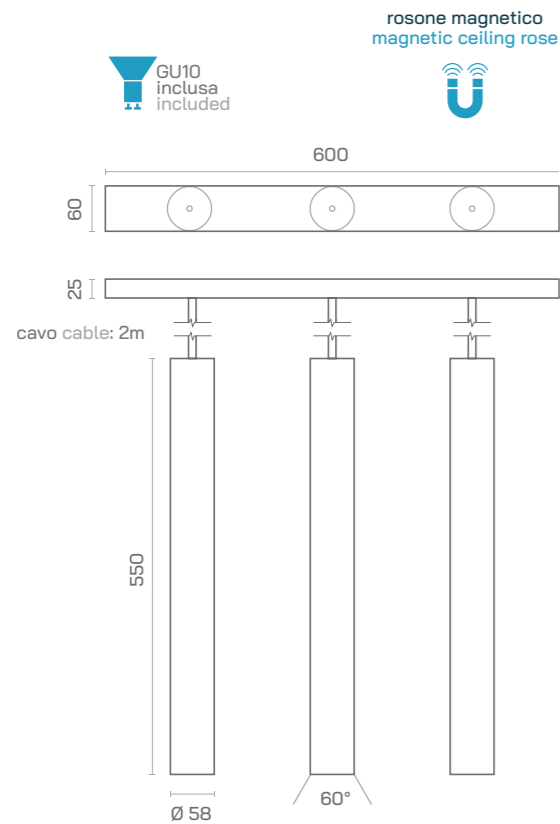

TR693

FINITURE FINISHINGS

GALVANIZZATE  
GALVANIC

-OT  
ottone brass

-BZ  
bronzo bronze

-TI  
titanio titanium

-BR  
brunito burnished

-CF  
c. di fucile metalgun

GRAFITE  
GRAPHITE

-BI  
bianco white

-NE  
nero black

-CO  
corten corten

Faretto recesso, temperatura colore 3000K,  
rosone magnetico  
Recessed spotlight, 3000K color  
temperature, magnetic ceiling rose

unità di misura - unit of measurement: mm

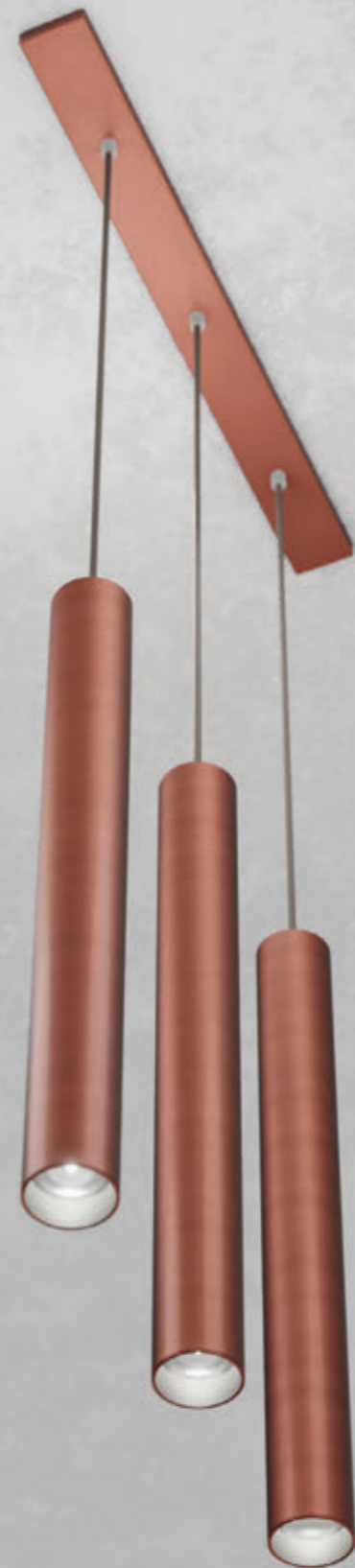

ORGANO  
CICCIO x4  
ROSONE CEILING ROSE

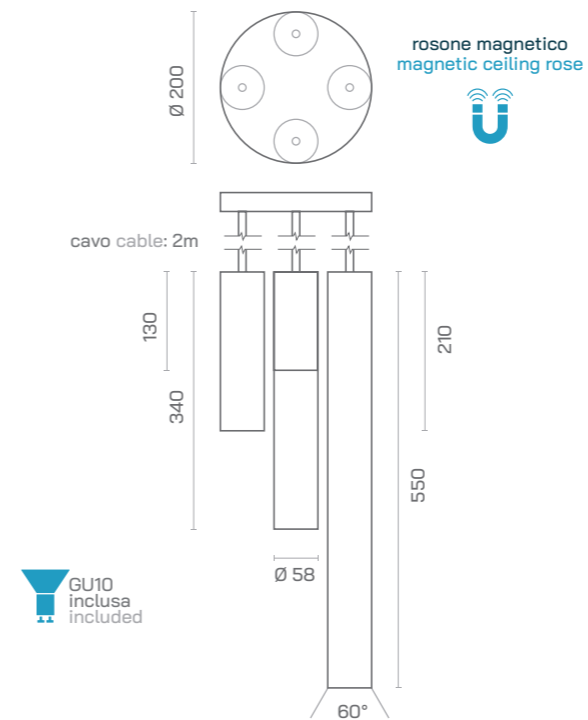

TR694

FINITURE FINISHINGS

GALVANIZZATE  
GALVANIC

-OT  
ottone brass

-BZ  
bronzo bronze

-TI  
titanio titanium

-BR  
brunito burnished

-CF  
c. di fucile metalgun

GRAFITE  
GRAPHITE

-BI  
bianco white

-NE  
nero black

-CO  
corten corten

Faretto recesso, temperatura colore 3000K,  
rosone magnetico  
Recessed spotlight, 3000K color  
temperature, magnetic ceiling rose

unità di misura - unit of measurement: mm

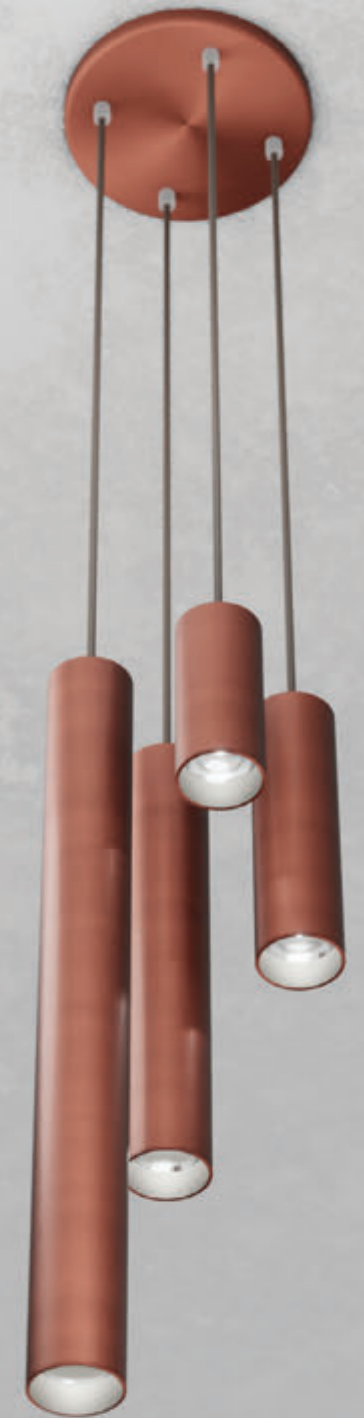

OPZIONI OPTIONS

LAMPADINA BULB

2700K -GLC  
4000K -GLF  
3000K -GLN DEFAULT  
6W - 220V - 594lm - CRI >90Ra

2700K -GPC  
4000K -GPF  
3000K -GPN  
12W - 220V - 950lm - CRI >90Ra



DIMMABLE



SUPER  
POWER

OPZIONI OPTIONS

LAMPADINA BULB

2700K -GLC  
4000K -GLF  
3000K -GLN DEFAULT  
6W - 220V - 594lm - CRI >90Ra

2700K -GPC  
4000K -GPF  
3000K -GPN  
12W - 220V - 950lm - CRI >90Ra



DIMMABLE



SUPER  
POWER

PLAFONIERA CEILING LIGHT  
KIATTO  
FISSA FIXED

TP861

attacco magnetico  
magnetic attachment

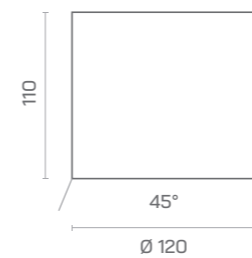

AR111 GU10  
include  
included

FINITURE FINISHINGS

GALVANIZZATE  
GALVANIC

- OT  
ottone brass
- BZ  
bronzo bronze
- TI  
titanio titanium
- BR  
brunito burnished
- CF  
c. di fucile metalgun

GRAFITE  
GRAPHITE

- BI  
bianco white
- NE  
nero black
- CO  
corten corten

Faretto recesso, temperatura colore 3000K, attacco magnetico  
Recessed spotlight, 3000K color temperature, magnetic attachment

unità di misura - unit of measurement: mm



TOBE  
PLAFONIERE  
CEILING LIGHTS

OPZIONI OPTIONS

LAMPADINA  
BULB

- 2700K -ALC DIMMABLE
- 4000K -ALF
- 3000K -ALN DEFAULT
- 13W - 220V - 900lm - CRI >90Ra

PLAFONIERA CEILING LIGHT  
CICCIO  
FISSA FIXED

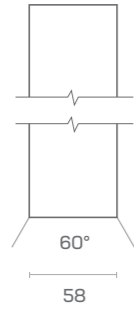

attacco magnetico  
magnetic attachment

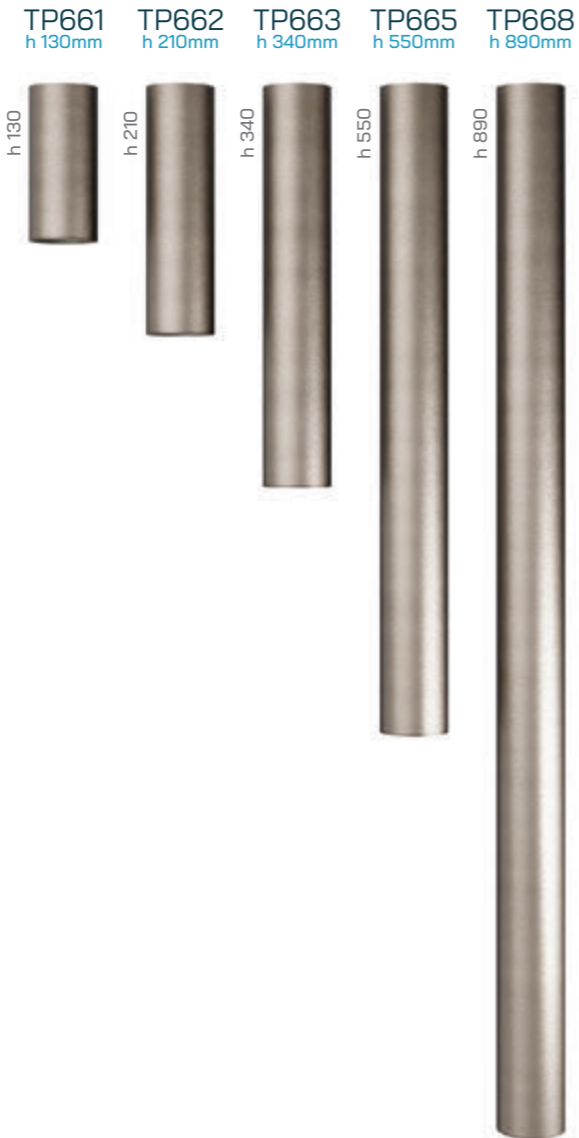

FINITURE FINISHINGS

GALVANIZZATE  
GALVANIC

- OT  
ottone brass
- BZ  
bronzo bronze
- TI  
titanio titanium
- BR  
brunito burnished
- CF  
c. di fucile metalgun

GRAFITE  
GRAPHITE

- BI  
bianco white
- NE  
nero black
- CO  
corten corten

Faretto recesso, temperatura colore 3000K, attacco magnetico  
Recessed spotlight, 3000K color temperature, magnetic attachment

unità di misura - unit of measurement: mm



OPZIONI OPTIONS

LAMPADINA BULB

2700K -GLC  
4000K -GLF  
3000K -GLN DEFAULT  
6W - 220V - 594lm - CRI >90Ra

2700K -GPC  
4000K -GPF  
3000K -GPN  
12W - 220V - 950lm - CRI >90Ra



PLAFONIERA CEILING LIGHT  
CICCIO 13x2  
ROSONE CEILING ROSE

TP612

FINITURE FINISHINGS

GALVANIZZATE  
GALVANIC

-  -OT  
ottone brass
-  -BZ  
bronzo bronze
-  -TI  
titanio titanium
-  -BR  
brunito burnished
-  -CF  
c. di fucile metalgun

GRAFITE  
GRAPHITE

-  -BI  
bianco white
-  -NE  
nero black
-  -CO  
corten corten

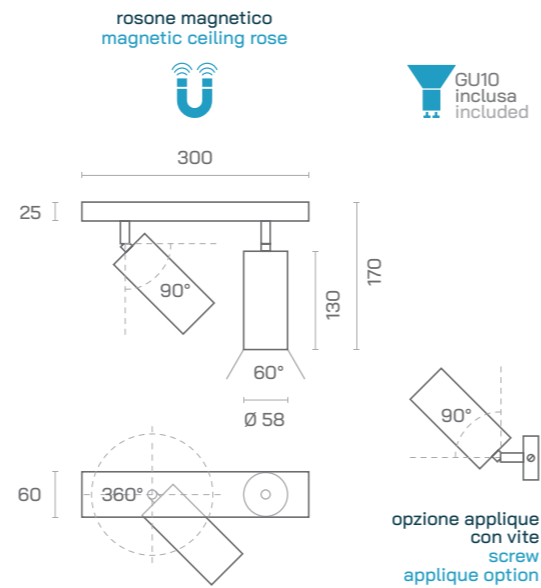

Faretto recesso, temperatura colore 3000K,  
rosone magnetico  
Recessed spotlight, 3000K color  
temperature, magnetic ceiling rose

unità di misura - unit of measurement: mm



PLAFONIERA CEILING LIGHT  
CICCIO 13x3  
ROSONE CEILING ROSE

TP613

FINITURE FINISHINGS

GALVANIZZATE  
GALVANIC

-  -OT  
ottone brass
-  -BZ  
bronzo bronze
-  -TI  
titanio titanium
-  -BR  
brunito burnished
-  -CF  
c. di fucile metalgun

GRAFITE  
GRAPHITE

-  -BI  
bianco white
-  -NE  
nero black
-  -CO  
corten corten

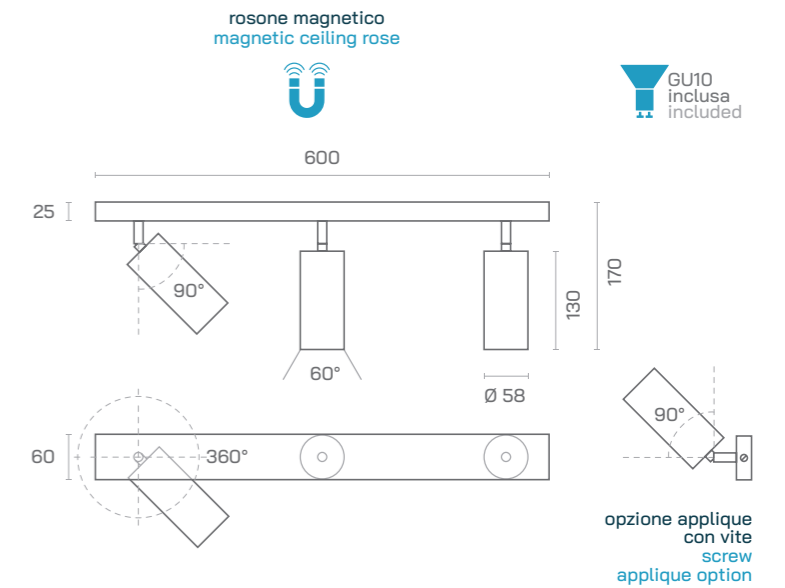

Faretto recesso, temperatura colore 3000K,  
rosone magnetico  
Recessed spotlight, 3000K color  
temperature, magnetic ceiling rose

unità di misura - unit of measurement: mm



OPZIONI OPTIONS

APPLIQUE -AP

LAMPADINA BULB

2700K -GLC  
4000K -GLF  
3000K -GLN DEFAULT  
6W - 220V - 594lm - CRI >90Ra

2700K -GPC  
4000K -GPF  
3000K -GPN  
12W - 220V - 950lm - CRI >90Ra



LAMPADINA A FILO  
FLAT

-FL

OPZIONI OPTIONS

APPLIQUE -AP

LAMPADINA BULB

2700K -GLC  
4000K -GLF  
3000K -GLN DEFAULT  
6W - 220V - 594lm - CRI >90Ra

2700K -GPC  
4000K -GPF  
3000K -GPN  
12W - 220V - 950lm - CRI >90Ra



LAMPADINA A FILO  
FLAT

-FL

PLAFONIERA CEILING LIGHT  
CICCIO 13x4  
ROSONE CEILING ROSE

rosone magnetico  
magnetic ceiling rose

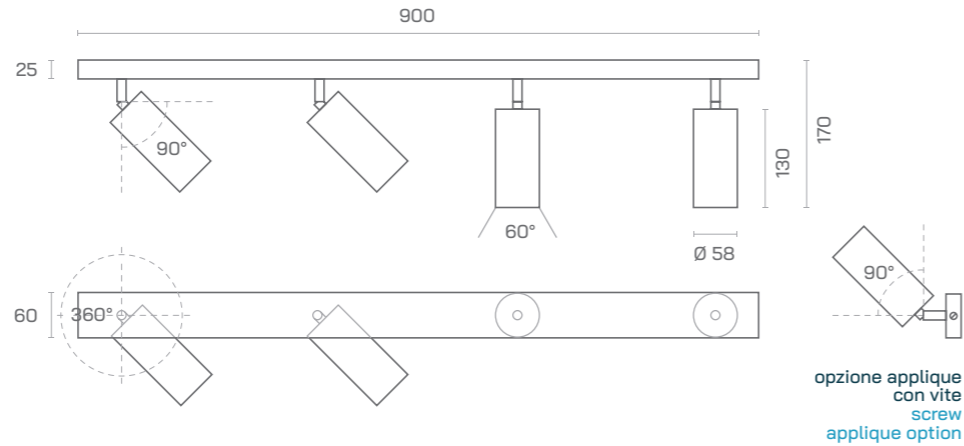

TP614

FINITURE FINISHINGS

GALVANIZZATE  
GALVANIC

- OT ottone brass
- BZ bronzo bronze
- TI titanio titanium
- BR brunito burnished
- CF c. di fucile metalgun

GRAFITE  
GRAPHITE

- BI bianco white
- NE nero black
- CO corten corten

Faretto recesso, temperatura colore 3000K,  
rosone magnetico  
Recessed spotlight, 3000K color  
temperature, magnetic ceiling rose

unità di misura - unit of measurement: mm

PLAFONIERA CEILING LIGHT  
CRICCO 13x2  
ROSONE CEILING ROSE

rosone magnetico  
magnetic ceiling rose



TP402

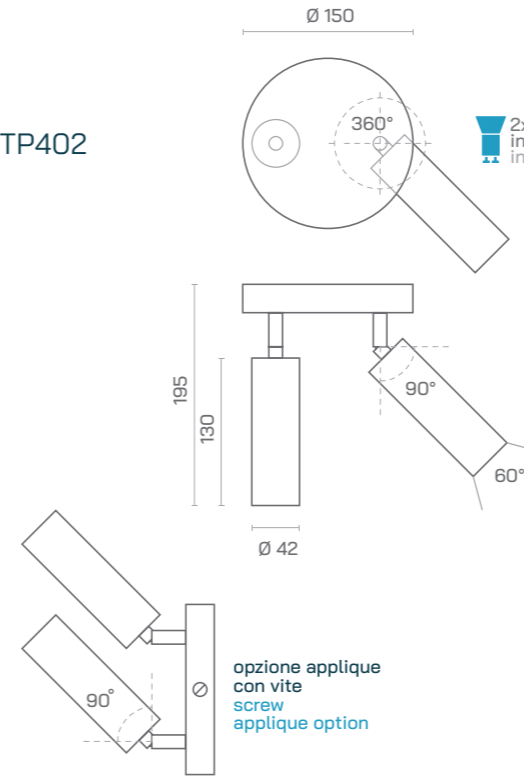

FINITURE FINISHINGS

GALVANIZZATE  
GALVANIC

- OT ottone brass
- BZ bronzo bronze
- TI titanio titanium
- BR brunito burnished
- CF c. di fucile metalgun

GRAFITE  
GRAPHITE

- BI bianco white
- NE nero black
- CO corten corten

Faretto recesso, temperatura colore 3000K, rosone magnetico  
Recessed spotlight, 3000K color temperature, magnetic ceiling rose

unità di misura - unit of measurement: mm



OPZIONI OPTIONS

APPLIQUE -AP

LAMPADINA BULB

2700K -GLC  
4000K -GLF  
3000K -GLN DEFAULT  
6W - 220V - 594lm - CRI >90Ra

2700K -GPC  
4000K -GPF  
3000K -GPN  
12W - 220V - 950lm - CRI >90Ra



LAMPADINA A FILO  
FLAT

-FL

OPZIONI OPTIONS

LAMPADINA  
BULB

2700K -MLC  
4000K -MLF  
3000K -MLN DEFAULT  
4W - 220V - 300lm - CRI >90Ra

APPLIQUE -AP

LAMPADINA A FILO  
FLAT

-FL

PLAFONIERA CEILING LIGHT  
CICCIO 8x2  
ROSONE CEILING ROSE

TP602

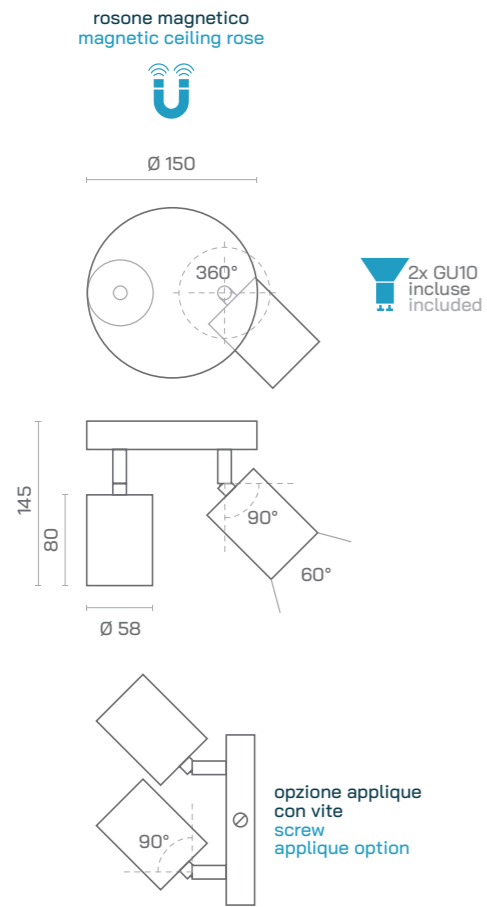

FINITURE FINISHINGS

GALVANIZZATE  
GALVANIC

- OT  
ottone brass
- BZ  
bronzo bronze
- TI  
titanio titanium
- BR  
brunito burnished
- CF  
c. di fucile metalgun

GRAFITE  
GRAPHITE

- BI  
bianco white
- NE  
nero black
- CO  
corten corten

Faretto con lampadina a filo, colore 3000K, rosone magnetico  
Flat spotlight, 3000K color temperature, magnetic ceiling rose

unità di misura - unit of measurement: mm



PLAFONIERA CEILING LIGHT  
CICCIO 8x3  
ROSONE CEILING ROSE

TP603

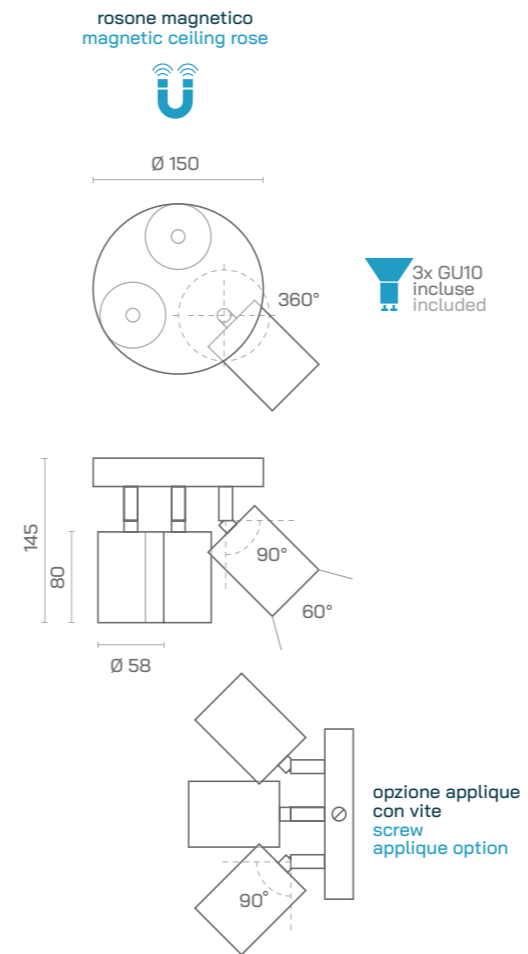

FINITURE FINISHINGS

GALVANIZZATE  
GALVANIC

- OT  
ottone brass
- BZ  
bronzo bronze
- TI  
titanio titanium
- BR  
brunito burnished
- CF  
c. di fucile metalgun

GRAFITE  
GRAPHITE

- BI  
bianco white
- NE  
nero black
- CO  
corten corten

Faretto con lampadina a filo, colore 3000K, rosone magnetico  
Flat spotlight, 3000K color temperature, magnetic ceiling rose

unità di misura - unit of measurement: mm



OPZIONI OPTIONS

LAMPADINA BULB

- 2700K -GLC
- 4000K -GLF
- 3000K -GLN DEFAULT
- 6W - 220V - 594lm - CRI >90Ra

APPLIQUE -AP

LAMPADINA RECESSA  
RECESSED BULB

- RE

OPZIONI OPTIONS

LAMPADINA BULB

- 2700K -GLC
- 4000K -GLF
- 3000K -GLN DEFAULT
- 6W - 220V - 594lm - CRI >90Ra

APPLIQUE -AP

LAMPADINA RECESSA  
RECESSED BULB

- RE



SOSPENSIONE PENDANT  
KIATTO  
BINARIO TRACK

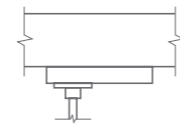

BINARIO TRACK  
TS881

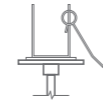

INCASSO RECESSED  
TS871



ROSONE CEILING ROSE  
TS811

cavo cable: 2m

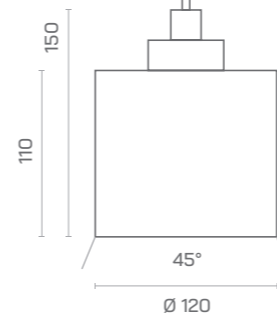

FINITURE FINISHINGS

GALVANIZZATE  
GALVANIC

-  -OT  
ottone brass
-  -BZ  
bronzo bronze
-  -TI  
titanio titanium
-  -BR  
brunito burnished
-  -CF  
c. di fucile metalgun

GRAFITE  
GRAPHITE

-  -BI  
bianco white
-  -NE  
nero black
-  -CO  
corten corten

Faretto recesso, binario trifase, temperatura colore 3000K  
Recessed spotlight, triphase track, 3000K color temperature

unità di misura - unit of measurement: mm

TOBE  
SOSPENSIONI  
PENDANTS

OPZIONI OPTIONS

- MONOFASE  
SINGLE PHASE
- MF

LAMPADINA  
BULB

- 2700K -ALC
  - 4000K -ALF
  - 3000K -ALN DEFAULT
  - 13W - 220V - 900lm - CRI >90Ra
-  DIMMABLE





SOSPENSIONE PENDANT  
CRICCO T13  
TIGE

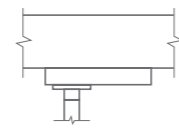

BINARIO  
TRACK  
TS478

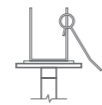

INCASSO  
RECESSED  
TS477

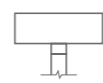

ROSONE  
CEILING ROSE  
TS471

tige: 450mm

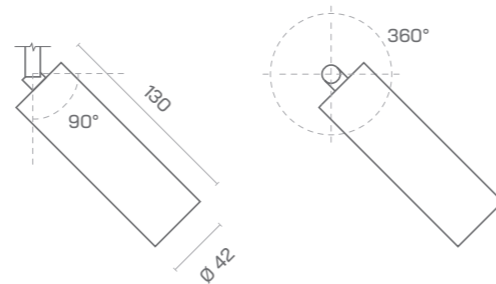

lampadina  
non inclusa  
bulb  
not included

FINITURE FINISHINGS

GALVANIZZATE  
GALVANIC

-  -OT  
ottone brass
-  -BZ  
bronzo bronze
-  -TI  
titanio titanium
-  -BR  
brunito burnished
-  -CF  
c. di fucile metalgun

GRAFITE  
GRAPHITE

-  -BI  
bianco white
-  -NE  
nero black
-  -CO  
corten corten

unità di misura - unit of measurement: mm

SOSPENSIONE PENDANT  
CRICCO T13x2  
TIGE

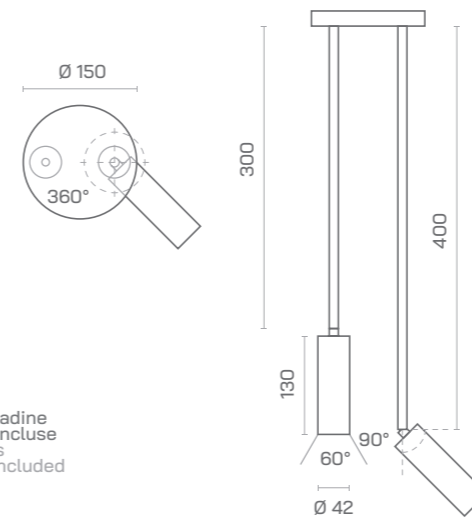

TS472

lampadine  
non incluse  
bulbs  
not included

unità di misura - unit of measurement: mm

SOSPENSIONE PENDANT  
CRICCO T13x3  
TIGE

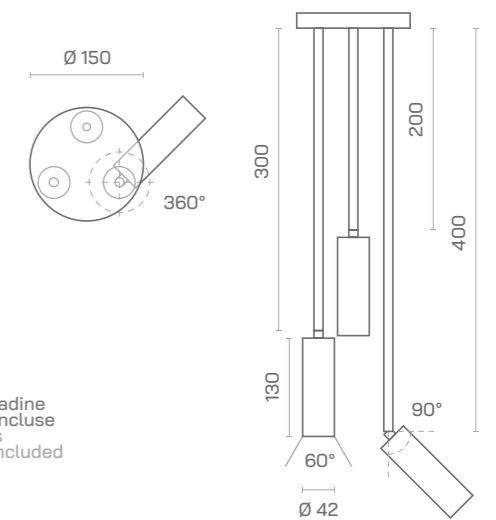

TS473

lampadine  
non incluse  
bulbs  
not included

unità di misura - unit of measurement: mm





SOSPENSIONE PENDANT  
CRICCO 13  
PENDENTE PENDEL

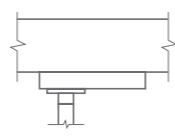

BINARIO  
TRACK  
TS498



INCASSO  
RECESSED  
TS497

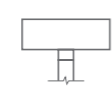

ROSONE  
CEILING ROSE  
TS491

cavo cable: 2m

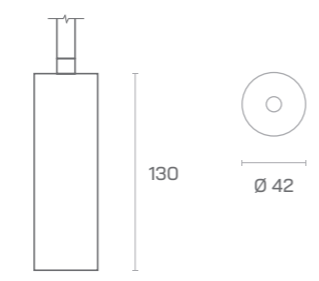

lampadina non inclusa  
bulb not included

FINITURE FINISHINGS

GALVANIZZATE  
GALVANIC

-  -OT  
ottone brass
-  -BZ  
bronzo bronze
-  -TI  
titanio titanium
-  -BR  
brunito burnished
-  -CF  
c. di fucile metalgun

GRAFITE  
GRAPHITE

-  -BI  
bianco white
-  -NE  
nero black
-  -CO  
corten corten

unità di misura - unit of measurement: mm

SOSPENSIONE PENDANT  
CRICCO 13x2  
PENDENTE PENDEL

TS492

lampadine non incluse  
bulbs not included

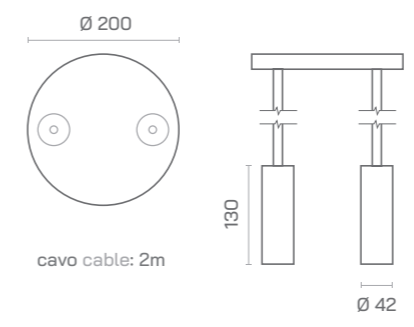

unità di misura - unit of measurement: mm

SOSPENSIONE PENDANT  
CRICCO 13x3  
PENDENTE PENDEL

TS493

lampadine non incluse  
bulbs not included

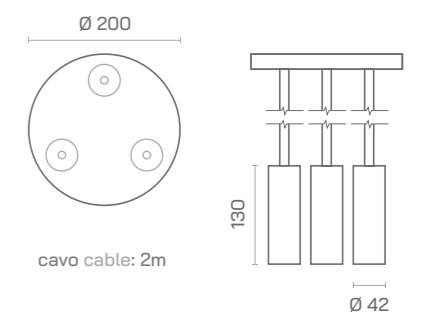

unità di misura - unit of measurement: mm





## APPLIQUE CRICCO E27 ROSONE CEILING ROSE



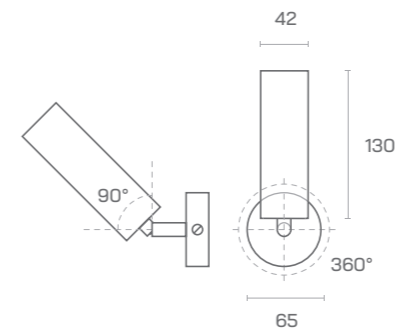

lampadina  
non inclusa  
bulb  
not included



TA201

### FINITURE FINISHINGS

#### GALVANIZZATE GALVANIC

-  -OT  
ottone brass
-  -BZ  
bronzo bronze
-  -TI  
titanio titanium
-  -BR  
brunito burnished
-  -CF  
c. di fucile metalgun

#### GRAFITE GRAPHITE

-  -BI  
bianco white
-  -NE  
nero black
-  -CO  
corten corten

unità di misura - unit of measurement: mm



## TOBE APPLIQUE APPLIQUES

## APPLIQUE CRICCO E27x2 ROSONE CEILING ROSE

lampadina  
non inclusa  
bulb  
not included

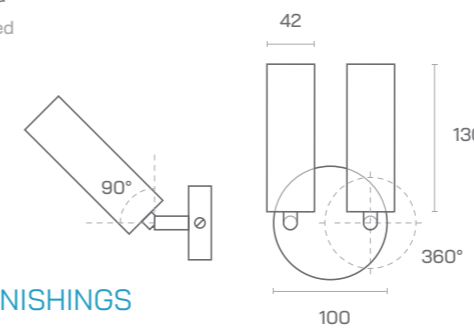

TA202

### FINITURE FINISHINGS

#### GALVANIZZATE GALVANIC

-  -OT  
ottone brass
-  -BZ  
bronzo bronze
-  -TI  
titanio titanium
-  -BR  
brunito burnished
-  -CF  
c. di fucile metalgun

#### GRAFITE GRAPHITE

-  -BI  
bianco white
-  -NE  
nero black
-  -CO  
corten corten

unità di misura - unit of measurement: mm



APPLIQUE  
CICCIO 21  
MONOEMISSIONE SINGLE EMISSION

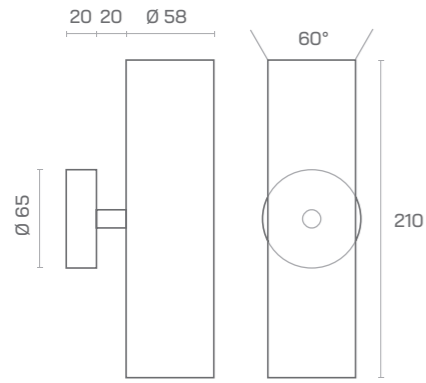

TA611

FINITURE FINISHINGS

GALVANIZZATE  
GALVANIC

-OT  
ottone brass

-BZ  
bronzo bronze

-TI  
titanio titanium

-BR  
brunito burnished

-CF  
c. di fucile metalgun

GRAFITE  
GRAPHITE

-BI  
bianco white

-NE  
nero black

-CO  
corten corten

Faretto con lampadina a filo, temperatura colore 3000K  
Flat spotlight, 3000K color temperature

unità di misura - unit of measurement: mm



APPLIQUE  
CICCIO 21x2  
BIEMISSIONE BI-EMISSION

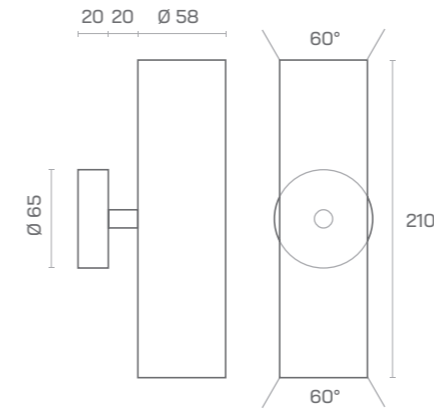

TA612

FINITURE FINISHINGS

GALVANIZZATE  
GALVANIC

-OT  
ottone brass

-BZ  
bronzo bronze

-TI  
titanio titanium

-BR  
brunito burnished

-CF  
c. di fucile metalgun

GRAFITE  
GRAPHITE

-BI  
bianco white

-NE  
nero black

-CO  
corten corten

Faretto con lampadina a filo, temperatura colore 3000K  
Flat spotlight, 3000K color temperature

unità di misura - unit of measurement: mm



OPZIONI OPTIONS

LAMPADINA RECESSA  
RECESSED BULB

-RE

LAMPADINA BULB

2700K -GLC  
4000K -GLF  
3000K -GLN DEFAULT  
6W - 220V - 594lm - CRI >90Ra

OPZIONI OPTIONS

LAMPADINA RECESSA  
RECESSED BULB

-RE

LAMPADINA BULB

2700K -GLC  
4000K -GLF  
3000K -GLN DEFAULT  
6W - 220V - 594lm - CRI >90Ra



## QUBE ORGANO

La successione Fibonacci, le finiture galvaniche, le lampadine intercambiabili attraverso diffusori recessi magnetici. Tutta l'eleganza della serie Organo "al quadrato"  
The Fibonacci sequence, the galvanic finishings, the interchangeable bulbs through magnetic recessed diffusers. All the elegance of the "squared" Organ series

Convinto dalla tangente,  
il cerchio accettò  
di trasformarsi in quadrato.  
L'angolo invece rifiutò: era sempre  
stato retto e tale voleva restare  
Convinced of the tangent,  
the circle agreed  
to turn into a square.  
The corner, on the other hand,  
refused: it had always been  
straight and it wanted to remain so

# QUBE

ORGANO

PLAFONIERA CEILING LIGHT  
APPLIQUE



# ORGANO QUBINO

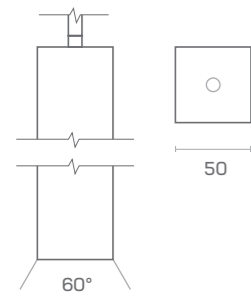

mini GU10  
inclusa  
included

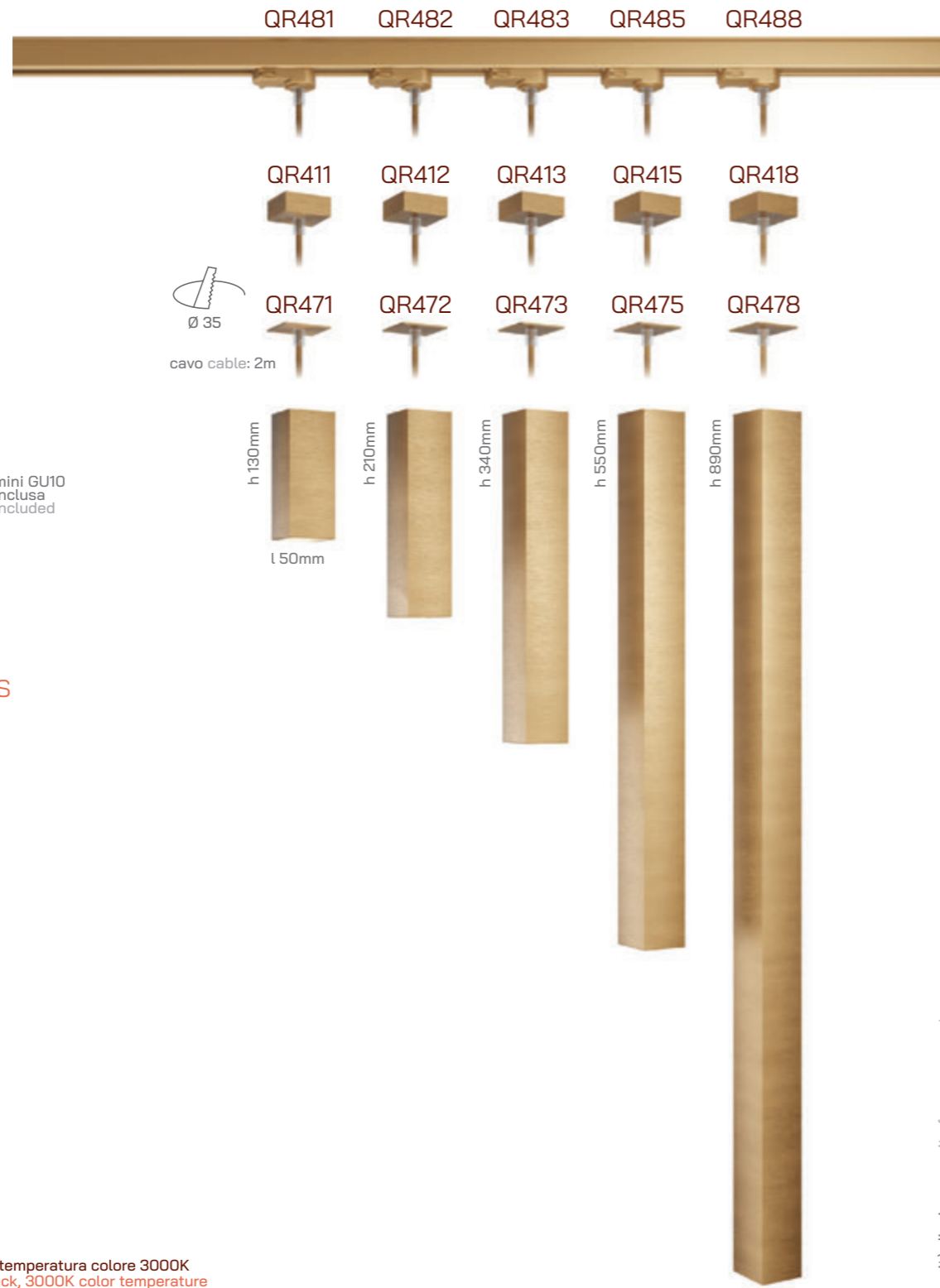

## FINITURE FINISHINGS

### GALVANIZZATE GALVANIC

- OT  
ottone brass
- BZ  
bronzo bronze
- TI  
titanio titanium
- BR  
brunito burnished
- CF  
c. di fucile metalgun

### GRAFITE GRAPHITE

- BI  
bianco white
- NE  
nero black
- CO  
corten corten

Faretto recesso, binario trifase, temperatura colore 3000K  
Recessed spotlight, triphase track, 3000K color temperature

unità di misura - unit of measurement: mm



## OPZIONI OPTIONS

### LAMPADINA BULB

2700K -MLC  
4000K -MLF  
3000K -MLN DEFAULT  
4W - 220V - 300lm - CRI >90Ra

### MONOFASE SINGLE PHASE

-MF

# ORGANO QUBETTO

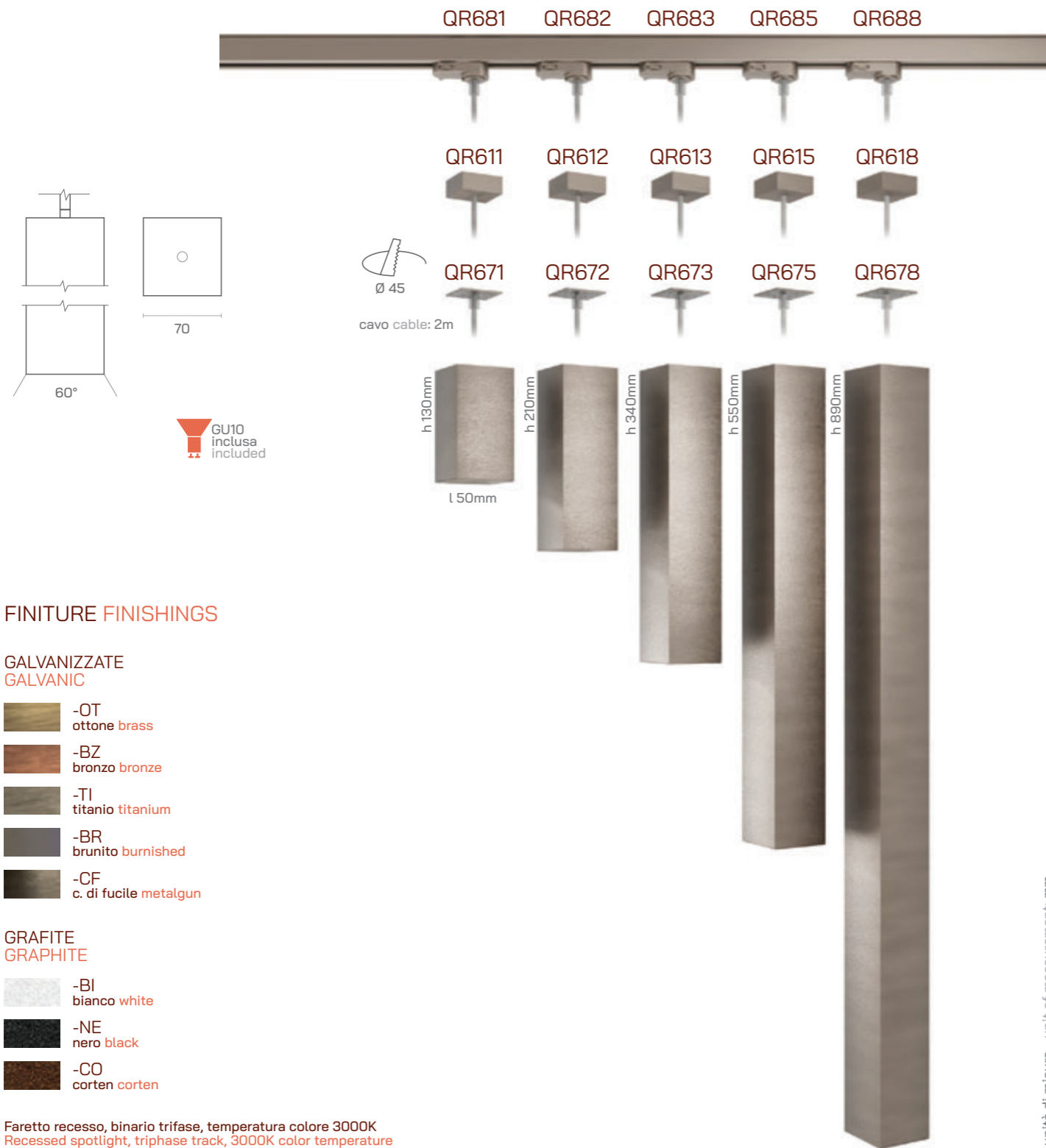

## OPZIONI OPTIONS

## LAMPADINA BULB

2700K -GLC  
4000K -GLF  
3000K -GLN DEFAULT  
6W - 220V - 594lm - CRI >90Ra

2700K -GPC  
4000K -GPF  
3000K -GPN  
12W - 220V - 950lm - CRI >90Ra

DIMMABLE  
 SUPER POWER

## MONOFASE SINGLE PHASE

-MF

ORGANO  
QUBINO 55x3  
ROSONE CEILING ROSE

QR493

rosone magnetico  
magnetic ceiling rose

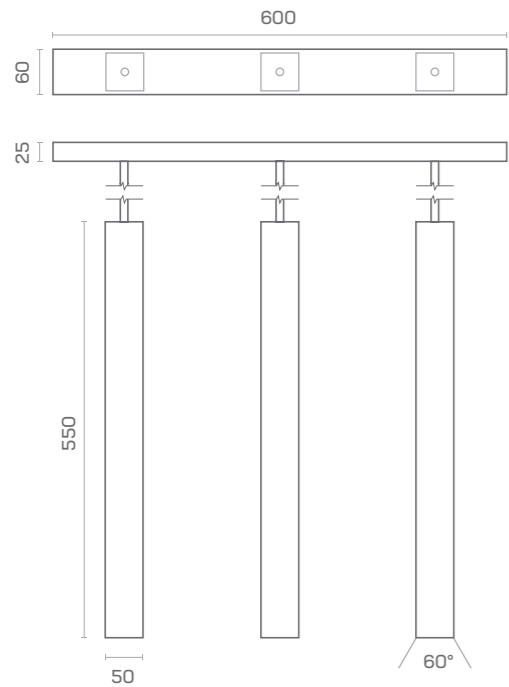

mini GU10  
inclusa  
included

FINITURE FINISHINGS

GALVANIZZATE  
GALVANIC

-OT  
ottone brass

-BZ  
bronzo bronze

-TI  
titanio titanium

-BR  
brunito burnished

-CF  
c. di fucile metalgun

GRAFITE  
GRAPHITE

-BI  
bianco white

-NE  
nero black

-CO  
corten corten

Faretto recesso, temperatura colore 3000K,  
rosone magnetico  
Recessed spotlight, 3000K color  
temperature, magnetic ceiling rose

unità di misura - unit of measurement: mm



OPZIONI OPTIONS

LAMPADINA  
BULB

2700K -MLC

4000K -MLF

3000K -MLN DEFAULT

4W - 220V - 300lm - CRI >90Ra

ORGANO  
QUBINO x4  
ROSONE CEILING ROSE

QR494

rosone magnetico  
magnetic ceiling rose

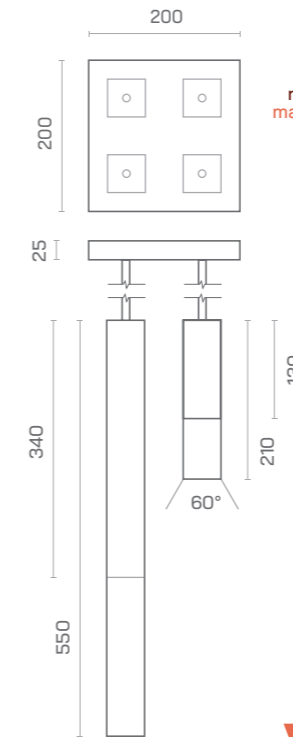

mini GU10  
inclusa  
included

FINITURE FINISHINGS

GALVANIZZATE  
GALVANIC

-OT  
ottone brass

-BZ  
bronzo bronze

-TI  
titanio titanium

-BR  
brunito burnished

-CF  
c. di fucile metalgun

GRAFITE  
GRAPHITE

-BI  
bianco white

-NE  
nero black

-CO  
corten corten

Faretto recesso, temperatura colore 3000K,  
rosone magnetico  
Recessed spotlight, 3000K color  
temperature, magnetic ceiling rose

unità di misura - unit of measurement: mm

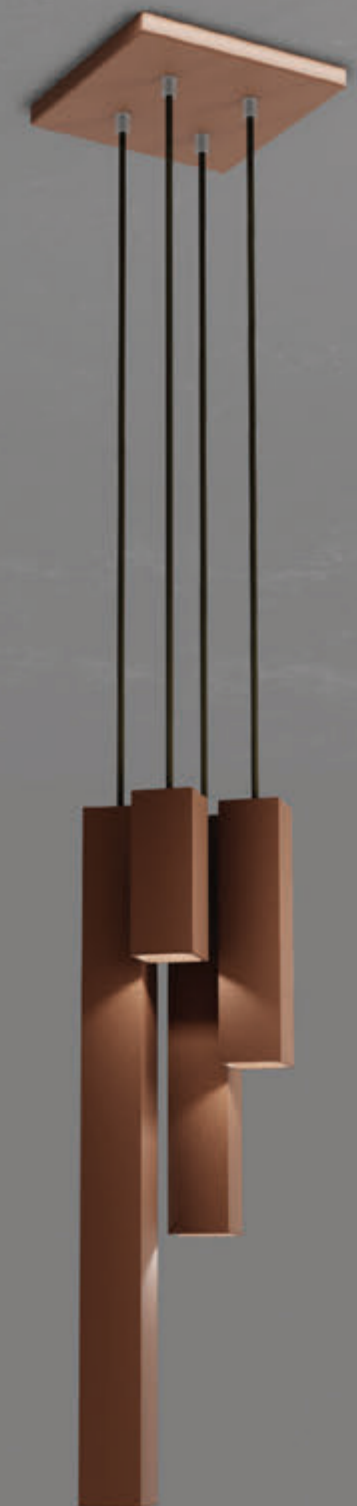

OPZIONI OPTIONS

LAMPADINA  
BULB

2700K -MLC

4000K -MLF

3000K -MLN DEFAULT

4W - 220V - 300lm - CRI >90Ra



ORGANO  
QUBETTO 55x3  
ROSONE CEILING ROSE

QR693

rosone magnetico  
magnetic ceiling rose

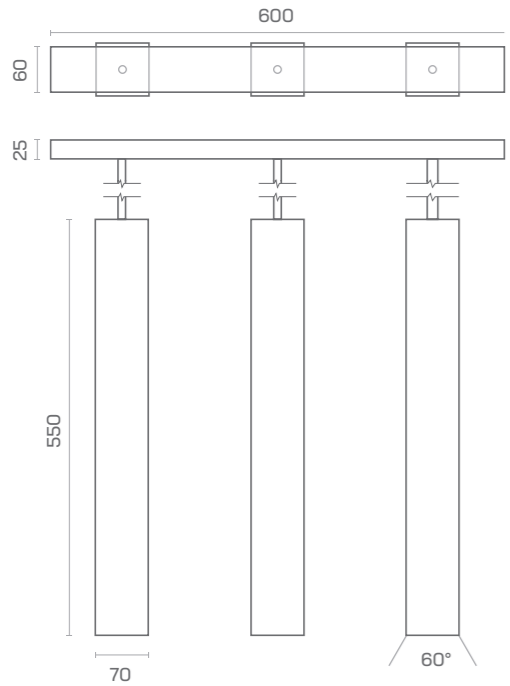

FINITURE FINISHINGS



GALVANIZZATE  
GALVANIC

-OT  
ottone brass

-BZ  
bronzo bronze

-TI  
titanio titanium

-BR  
brunito burnished

-CF  
c. di fucile metalgun

GRAFITE  
GRAPHITE

-BI  
bianco white

-NE  
nero black

-CO  
corten corten

Faretto recesso, temperatura colore 3000K,  
rosone magnetico  
Recessed spotlight, 3000K color  
temperature, magnetic ceiling rose

unità di misura - unit of measurement: mm



OPZIONI OPTIONS

LAMPADINA BULB

2700K -GLC  
4000K -GLF  
3000K -GLN DEFAULT  
6W - 220V - 594lm - CRI >90Ra

2700K -GPC DIMMABLE  
4000K -GPF SUPER POWER  
3000K -GPN SUPER POWER  
12W - 220V - 950lm - CRI >90Ra

ORGANO  
QUBETTO x4  
ROSONE CEILING ROSE

QR694

rosone magnetico  
magnetic ceiling rose

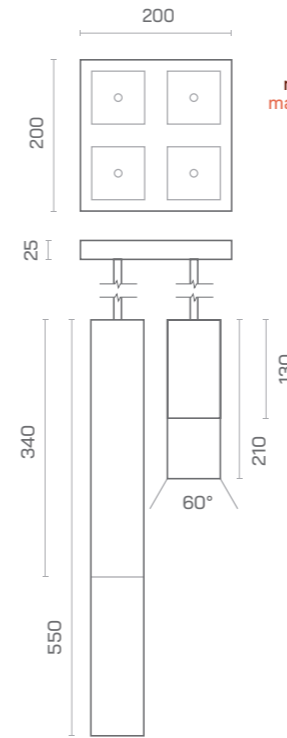

FINITURE FINISHINGS



GALVANIZZATE  
GALVANIC

-OT  
ottone brass

-BZ  
bronzo bronze

-TI  
titanio titanium

-BR  
brunito burnished

-CF  
c. di fucile metalgun

GRAFITE  
GRAPHITE

-BI  
bianco white

-NE  
nero black

-CO  
corten corten

Faretto recesso, temperatura colore 3000K,  
rosone magnetico  
Recessed spotlight, 3000K color  
temperature, magnetic ceiling rose

unità di misura - unit of measurement: mm



OPZIONI OPTIONS

LAMPADINA BULB

2700K -GLC  
4000K -GLF  
3000K -GLN DEFAULT  
6W - 220V - 594lm - CRI >90Ra

2700K -GPC DIMMABLE  
4000K -GPF SUPER POWER  
3000K -GPN SUPER POWER  
12W - 220V - 950lm - CRI >90Ra

# PLAFONIERA CEILING LIGHT QUBOTTO

QP861

attacco magnetico  
magnetic attachment

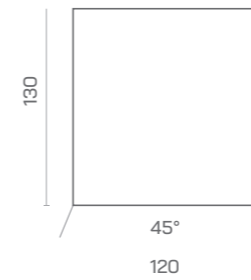

AR111 GU10  
include  
included



## FINITURE FINISHINGS

### GALVANIZZATE GALVANIC

-OT  
ottone brass

-BZ  
bronzo bronze

-TI  
titanio titanium

-BR  
brunito burnished

-CF  
c. di fucile metalgun

### GRAFITE GRAPHITE

-BI  
bianco white

-NE  
nero black

-CO  
corten corten

Faretto recesso, temperatura colore 3000K,  
attacco magnetico  
Recessed spotlight, 3000K color  
temperature, magnetic attachment

unità di misura - unit of measurement: mm



## QUBE PLAFONIERE CEILING LIGHTS

## OPZIONI OPTIONS

### LAMPADINA BULB

2700K -ALC  
4000K -ALF  
3000K -ALN DEFAULT  
13W - 220V - 900lm - CRI >90Ra



# PLAFONIERA CEILING LIGHT QUBETTO

attacco magnetico  
magnetic attachment

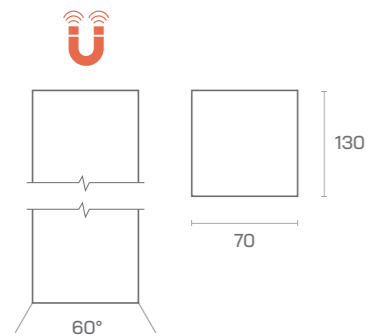

QP661 h 130mm    QP662 h 210mm    QP663 h 340mm    QP665 h 550mm    QP668 h 890mm



unità di misura - unit of measurement: mm

## FINITURE FINISHINGS

### GALVANIZZATE GALVANIC

- QT  
ottone **brass**
- BZ  
bronzo **bronze**
- TI  
titanio **titanium**
- BR  
brunito **burnished**
- CF  
c. di fucile **metalgun**

### GRAFITE GRAPHITE

- BI  
bianco **white**
- NE  
nero **black**
- CO  
corten **corten**

Faretto recesso, binario trifase, temperatura colore 3000K, attacco magnetico  
Recessed spotlight, triphase track, 3000K color temperature, magnetic attachment



## OPZIONI OPTIONS

### LAMPADINA BULB

2700K -GLC  
4000K -GLF  
3000K -GLN DEFAULT  
6W - 220V - 594lm - CRI >90Ra

2700K -GPC    DIMMABLE  
4000K -GPF    SUPER  
3000K -GPN    POWER  
12W - 220V - 950lm - CRI >90Ra



QUBE  
APPLIQUE  
APPLIQUES

APPLIQUE  
**QUBETTO 21**  
 MONOEMISSIONE SINGLE EMISSION

QA612

attacco magnetico  
 magnetic attachment

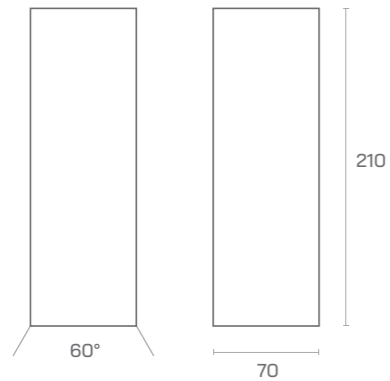

FINITURE FINISHINGS

GALVANIZZATE  
 GALVANIC

-OT  
 ottone brass

-BZ  
 bronzo bronze

-TI  
 titanio titanium

-BR  
 brunito burnished

-CF  
 c. di fucile metalgun

GRAFITE  
 GRAPHITE

-BI  
 bianco white

-NE  
 nero black

-CO  
 corten corten

Faretto recesso, temperatura colore 3000K,  
 attacco magnetico  
 Recessed spotlight, 3000K color  
 temperature, magnetic attachment

unità di misura - unit of measurement: mm



APPLIQUE  
**QUBETTO 21x2**  
 BIEMISSIONE BI-EMISSION

QA622

attacco magnetico  
 magnetic attachment

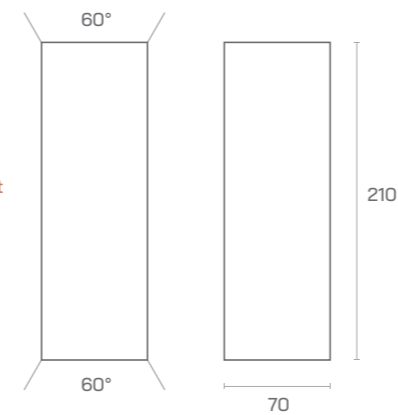

FINITURE FINISHINGS

GALVANIZZATE  
 GALVANIC

-OT  
 ottone brass

-BZ  
 bronzo bronze

-TI  
 titanio titanium

-BR  
 brunito burnished

-CF  
 c. di fucile metalgun

GRAFITE  
 GRAPHITE

-BI  
 bianco white

-NE  
 nero black

-CO  
 corten corten

Faretto recesso, temperatura colore 3000K,  
 attacco magnetico  
 Recessed spotlight, 3000K color  
 temperature, magnetic attachment

unità di misura - unit of measurement: mm



OPZIONI OPTIONS

LAMPADINA BULB

2700K -GLC  
 4000K -GLF  
 3000K -GLN DEFAULT  
 6W - 220V - 594lm - CRI >90Ra

OPZIONI OPTIONS

LAMPADINA BULB

2700K -GLC  
 4000K -GLF  
 3000K -GLN DEFAULT  
 6W - 220V - 594lm - CRI >90Ra



Perfezione armonia pulizia geometria e tecnologia  
Verniciate in grafite o galvanizzate, applique o sospensioni  
Dana e Luna per interno o esterno IP65 con led driver integrato  
Pois Card e Favo da interno con lampadine GX53  
La potenza nel minimo ingombro è possibile  
Perfection, harmony, clean geometry and technology  
Graphite painted or galvanized, applique or suspensions  
Dana and Luna for indoor or IP65 outdoor with integrated led driver  
Pois Card and Favo wall lamps for indoor use with GX53 bulbs  
Power in the smallest footprint is possible

# SLIM

APPLIQUE

PLAFONIERA CEILING LIGHT

SOSPENSIONI PENDANTS

# APPLIQUE LUNA

INTERNI INDOOR  
SA022

ESTERNI OUTDOOR  
SA062 IP65

POTENZA LUCE  
LIGHT POWER

-18W  
2450-2532-2722 lm  
-36W  
4900-5065-5445 lm **SUPER POWER**

COLORE LUCE  
LIGHT COLOR

-LLC  
2700K  
-LLN  
3000K  
-LLF  
4000K  
220V - CRI >90Ra

## FINITURE FINISHINGS

GALVANIZZATE  
GALVANIC

-  -OT  
ottone brass
-  -BZ  
bronzo bronze
-  -TI  
titanio titanium
-  -BR  
brunito burnished
-  -CF  
c. di fucile metalgun

GRAFITE  
GRAPHITE

-  -BI  
bianco white
-  -NE  
nero black
-  -CO  
corten corten

attacco magnetico  
magnetic attachment

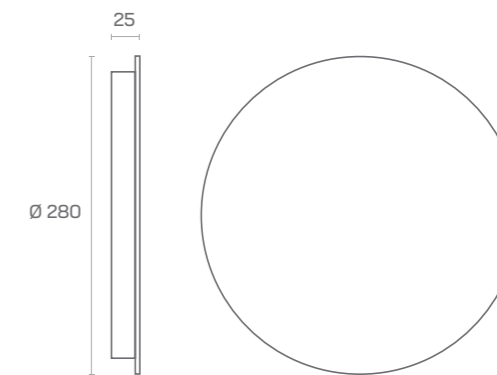

unità di misura - unit of measurement: mm

SLIM  
APPLIQUE  
APPLIQUES

APPLIQUE  
DANA 30  
MONOEMISSIONE SINGLE EMISSION

APPLIQUE  
DANA 30x2  
BIEMISSIONE BI-EMISSION



PER INTERNI  
INDOOR  
SA123

PER ESTERNI  
OUTDOOR  
SA163 IP65

POTENZA LUCE  
LIGHT POWER

-6W  
980-1020-1135 lm  
-12W  
1610-1640-1815 lm **SUPER POWER**

COLORE LUCE  
LIGHT COLOR

-LLC  
2700K

-LLN  
3000K

-LLF  
4000K

220V - CRI >90Ra

attacco magnetico  
magnetic attachment

FINITURE FINISHINGS

GALVANIZZATE  
GALVANIC

-OT  
ottone brass

-BZ  
bronzo bronze

-TI  
titanio titanium

-BR  
brunito burnished

-CF  
c. di fucile metalgun

GRAFITE  
GRAPHITE

-BI  
bianco white

-NE  
nero black

-CO  
corten corten

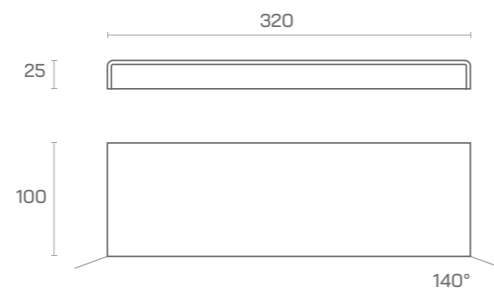

unità di misura - unit of measurement: mm

PER INTERNI  
INDOOR  
SA223

PER ESTERNI  
OUTDOOR  
SA263 IP65

POTENZA LUCE  
LIGHT POWER

-12W  
1960-2040-2270 lm  
-24W  
3220-3280-3630 lm **SUPER POWER**

COLORE LUCE  
LIGHT COLOR

-LLC  
2700K

-LLN  
3000K

-LLF  
4000K

220V - CRI >90Ra

attacco magnetico  
magnetic attachment

FINITURE FINISHINGS

GALVANIZZATE  
GALVANIC

-OT  
ottone brass

-BZ  
bronzo bronze

-TI  
titanio titanium

-BR  
brunito burnished

-CF  
c. di fucile metalgun

GRAFITE  
GRAPHITE

-BI  
bianco white

-NE  
nero black

-CO  
corten corten

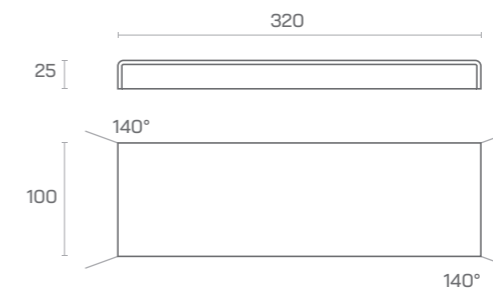

unità di misura - unit of measurement: mm



APPLIQUE  
DANA 60  
MONOEMISSIONE SINGLE EMISSION

APPLIQUE  
DANA 60x2  
BIEMISSIONE BI-EMISSION



PER INTERNI  
INDOOR  
SA126

PER ESTERNI  
OUTDOOR  
SA166 IP65

POTENZA LUCE  
LIGHT POWER

-12W  
1960-2040-2270 lm

-24W  
3220-3280-3630 lm **SUPER POWER**

COLORE LUCE  
LIGHT COLOR

-LLC  
2700K

-LLN  
3000K

-LLF  
4000K

220V - CRI >90Ra

attacco magnetico  
magnetic attachment

FINITURE FINISHINGS

GALVANIZZATE  
GALVANIC

-OT  
ottone brass

-BZ  
bronzo bronze

-TI  
titanio titanium

-BR  
brunito burnished

-CF  
c. di fucile metalgun

GRAFITE  
GRAPHITE

-BI  
bianco white

-NE  
nero black

-CO  
corten corten



unità di misura - unit of measurement: mm

PER INTERNI  
INDOOR  
SA226

PER ESTERNI  
OUTDOOR  
SA266 IP65

POTENZA LUCE  
LIGHT POWER

-24W  
3220-3280-3630 lm

-48W  
6440-6560-7260 lm **SUPER POWER**

COLORE LUCE  
LIGHT COLOR

-LLC  
2700K

-LLN  
3000K

-LLF  
4000K

220V - CRI >90Ra

attacco magnetico  
magnetic attachment

FINITURE FINISHINGS

GALVANIZZATE  
GALVANIC

-OT  
ottone brass

-BZ  
bronzo bronze

-TI  
titanio titanium

-BR  
brunito burnished

-CF  
c. di fucile metalgun

GRAFITE  
GRAPHITE

-BI  
bianco white

-NE  
nero black

-CO  
corten corten



unità di misura - unit of measurement: mm

APPLIQUE  
DANA 90  
MONOEMISSIONE SINGLE EMISSION

APPLIQUE  
DANA 90x2  
BIEMISSIONE BI-EMISSION



PER INTERNI  
INDOOR  
SA129

PER ESTERNI  
OUTDOOR  
SA169 IP65

POTENZA LUCE  
LIGHT POWER

-18W  
2450-2532-2722 lm

-36W  
4900-5065-5445 lm 

COLORE LUCE  
LIGHT COLOR

-LLC  
2700K

-LLN  
3000K

-LLF  
4000K

220V - CRI >90Ra

attacco magnetico  
magnetic attachment

FINITURE FINISHINGS

GALVANIZZATE  
GALVANIC

 -OT  
ottone brass

 -BZ  
bronzo bronze

 -TI  
titanio titanium

 -BR  
brunito burnished

 -CF  
c. di fucile metalgun

GRAFITE  
GRAPHITE

 -BI  
bianco white

 -NE  
nero black

 -CO  
corten corten

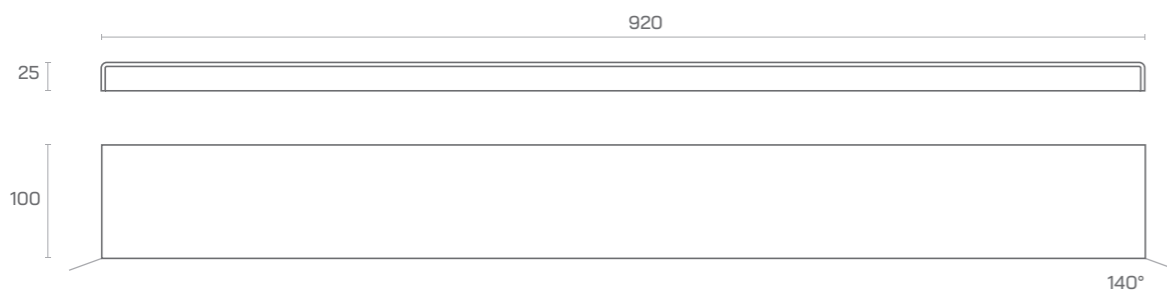

unità di misura - unit of measurement: mm

PER INTERNI  
INDOOR  
SA229

PER ESTERNI  
OUTDOOR  
SA269 IP65

POTENZA LUCE  
LIGHT POWER

-36W  
4900-5065-5445 lm

-72W  
9800-10130-10890 lm 

COLORE LUCE  
LIGHT COLOR

-LLC  
2700K

-LLN  
3000K

-LLF  
4000K

220V - CRI >90Ra

attacco magnetico  
magnetic attachment

FINITURE FINISHINGS

GALVANIZZATE  
GALVANIC

 -OT  
ottone brass

 -BZ  
bronzo bronze

 -TI  
titanio titanium

 -BR  
brunito burnished

 -CF  
c. di fucile metalgun

GRAFITE  
GRAPHITE

 -BI  
bianco white

 -NE  
nero black

 -CO  
corten corten

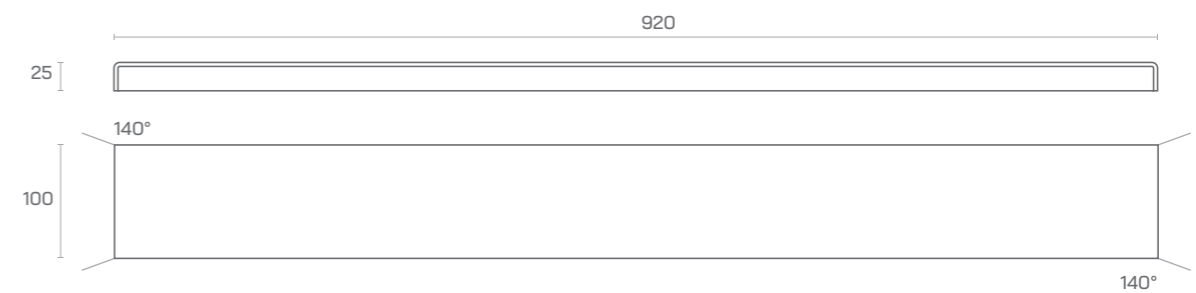

unità di misura - unit of measurement: mm

# PLAFONIERA CEILING LIGHT FAVO

SP611

## FINITURE FINISHINGS

### GALVANIZZATE GALVANIC

-  -OT  
ottone brass
-  -BZ  
bronzo bronze
-  -TI  
titanio titanium
-  -BR  
brunito burnished
-  -CF  
c. di fucile metalgun

### GRAFITE GRAPHITE

-  -BI  
bianco white
-  -NE  
nero black
-  -CO  
corten corten

attacco magnetico  
magnetic attachment



300

fascio di luce  
light beam  
110°

260

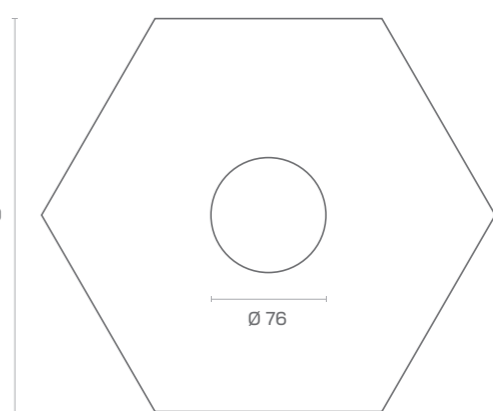

 GX53  
non inclusa  
not included

unità di misura - unit of measurement: mm

SLIM  
PLAFONIERE  
CEILING LIGHTS

OPZIONI OPTIONS

LAMPADINA  
BULB

3000K -XLN  
4000K -XLF  
6,5W - 220V - 700lm - CRI >90Ra

## PLAFONIERA CEILING LIGHT CARD x1

SP411

attacco magnetico  
magnetic attachment

fascio di luce  
light beam  
110°

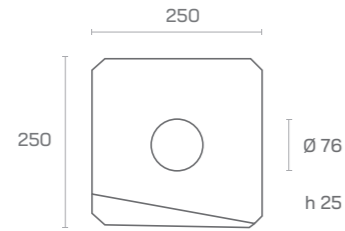

### FINITURE FINISHINGS

GX53  
non inclusa  
not included

#### GALVANIZZATE GALVANIC

-OT  
ottone brass

-BZ  
bronzo bronze

-TI  
titanio titanium

-BR  
brunito burnished

-CF  
c. di fucile metalgun

#### GRAFITE GRAPHITE

-BI  
bianco white

-NE  
nero black

-CO  
corten corten

unità di misura - unit of measurement: mm

### OPZIONI OPTIONS

#### LAMPADINA BULB

3000K -XLN  
4000K -XLF  
6,5W - 220V - 700lm - CRI >90Ra



## PLAFONIERA CEILING LIGHT CARD x3

SP413

attacco magnetico  
magnetic attachment

fascio di luce  
light beam  
110°

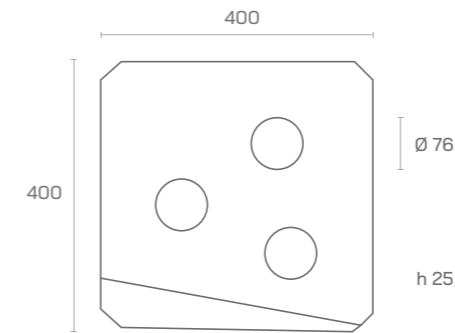

### FINITURE FINISHINGS

GX53  
non inclusa  
not included

#### GALVANIZZATE GALVANIC

-OT  
ottone brass

-BZ  
bronzo bronze

-TI  
titanio titanium

-BR  
brunito burnished

-CF  
c. di fucile metalgun

#### GRAFITE GRAPHITE

-BI  
bianco white

-NE  
nero black

-CO  
corten corten

unità di misura - unit of measurement: mm

### OPZIONI OPTIONS

#### LAMPADINA BULB

3000K -XLN  
4000K -XLF  
6,5W - 220V - 700lm - CRI >90Ra



## PLAFONIERA CEILING LIGHT CARD x2

SP412

attacco magnetico  
magnetic attachment

fascio di luce  
light beam  
110°

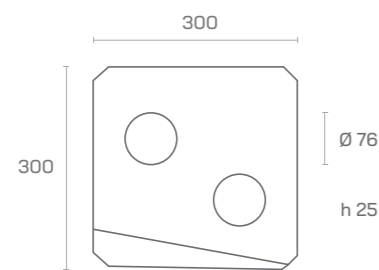

### FINITURE FINISHINGS

GX53  
non inclusa  
not included

#### GALVANIZZATE GALVANIC

-OT  
ottone brass

-BZ  
bronzo bronze

-TI  
titanio titanium

-BR  
brunito burnished

-CF  
c. di fucile metalgun

#### GRAFITE GRAPHITE

-BI  
bianco white

-NE  
nero black

-CO  
corten corten

unità di misura - unit of measurement: mm

### OPZIONI OPTIONS

#### LAMPADINA BULB

3000K -XLN  
4000K -XLF  
6,5W - 220V - 700lm - CRI >90Ra



## PLAFONIERA CEILING LIGHT CARD x4

SP414

attacco magnetico  
magnetic attachment

fascio di luce  
light beam  
110°

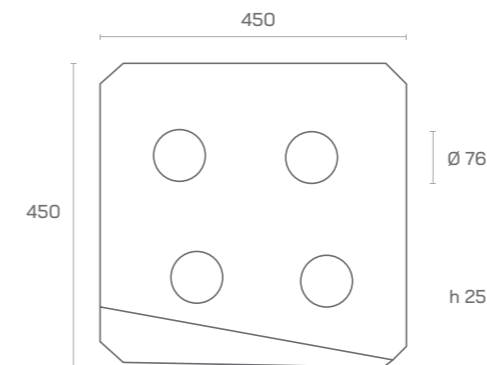

### FINITURE FINISHINGS

GX53  
non inclusa  
not included

#### GALVANIZZATE GALVANIC

-OT  
ottone brass

-BZ  
bronzo bronze

-TI  
titanio titanium

-BR  
brunito burnished

-CF  
c. di fucile metalgun

#### GRAFITE GRAPHITE

-BI  
bianco white

-NE  
nero black

-CO  
corten corten

unità di misura - unit of measurement: mm

### OPZIONI OPTIONS

#### LAMPADINA BULB

3000K -XLN  
4000K -XLF  
6,5W - 220V - 700lm - CRI >90Ra



## PLAFONIERA CEILING LIGHT POIS x1

SP011

attacco magnetico  
magnetic attachment



Ø 280

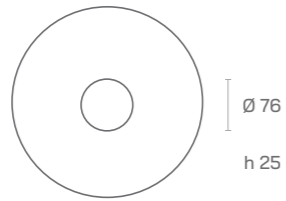

Ø 76

h 25

fascio di luce  
light beam  
110°

### FINITURE FINISHINGS



#### GALVANIZZATE GALVANIC

-OT  
ottone brass

-BZ  
bronzo bronze

-TI  
titanio titanium

-BR  
brunito burnished

-CF  
c. di fucile metalgun

#### GRAFITE GRAPHITE

-BI  
bianco white

-NE  
nero black

-CO  
corten corten

unità di misura - unit of measurement: mm

### OPZIONI OPTIONS

#### LAMPADINA BULB

3000K -XLN  
4000K -XLF  
6,5W - 220V - 700lm - CRI >90Ra



## PLAFONIERA CEILING LIGHT POIS x3

SP013

attacco magnetico  
magnetic attachment



Ø 450

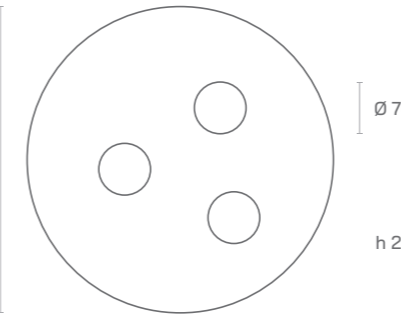

Ø 76

h 25

fascio di luce  
light beam  
110°

### FINITURE FINISHINGS



#### GALVANIZZATE GALVANIC

-OT  
ottone brass

-BZ  
bronzo bronze

-TI  
titanio titanium

-BR  
brunito burnished

-CF  
c. di fucile metalgun

#### GRAFITE GRAPHITE

-BI  
bianco white

-NE  
nero black

-CO  
corten corten

unità di misura - unit of measurement: mm

### OPZIONI OPTIONS

#### LAMPADINA BULB

3000K -XLN  
4000K -XLF  
6,5W - 220V - 700lm - CRI >90Ra



## PLAFONIERA CEILING LIGHT POIS x2

SP012

attacco magnetico  
magnetic attachment



Ø 350

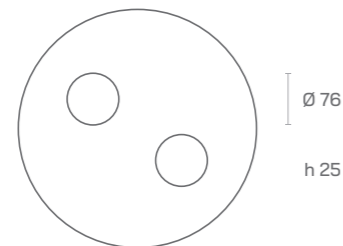

Ø 76

h 25

fascio di luce  
light beam  
110°

### FINITURE FINISHINGS



#### GALVANIZZATE GALVANIC

-OT  
ottone brass

-BZ  
bronzo bronze

-TI  
titanio titanium

-BR  
brunito burnished

-CF  
c. di fucile metalgun

#### GRAFITE GRAPHITE

-BI  
bianco white

-NE  
nero black

-CO  
corten corten

unità di misura - unit of measurement: mm

### OPZIONI OPTIONS

#### LAMPADINA BULB

3000K -XLN  
4000K -XLF  
6,5W - 220V - 700lm - CRI >90Ra



## PLAFONIERA CEILING LIGHT POIS x4

SP014

attacco magnetico  
magnetic attachment



Ø 500

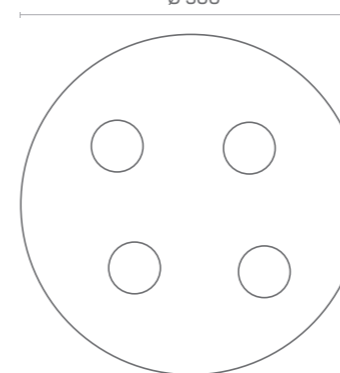

Ø 76

h 25

fascio di luce  
light beam  
110°

### FINITURE FINISHINGS



#### GALVANIZZATE GALVANIC

-OT  
ottone brass

-BZ  
bronzo bronze

-TI  
titanio titanium

-BR  
brunito burnished

-CF  
c. di fucile metalgun

#### GRAFITE GRAPHITE

-BI  
bianco white

-NE  
nero black

-CO  
corten corten

unità di misura - unit of measurement: mm

### OPZIONI OPTIONS

#### LAMPADINA BULB

3000K -XLN  
4000K -XLF  
6,5W - 220V - 700lm - CRI >90Ra

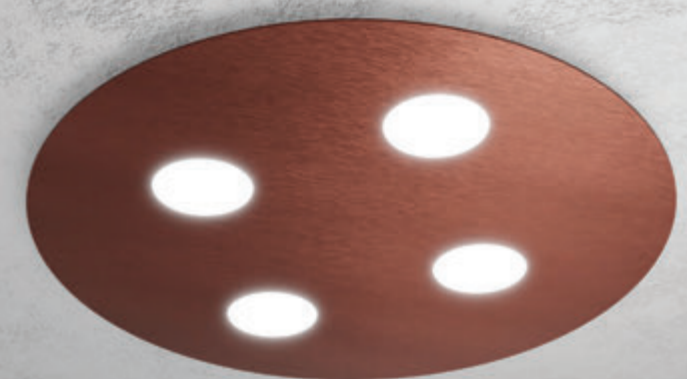

## SOSPENSIONI FAVO

SS611

rosone:  
ceiling rose:  
100mm - 100mm - 27mm

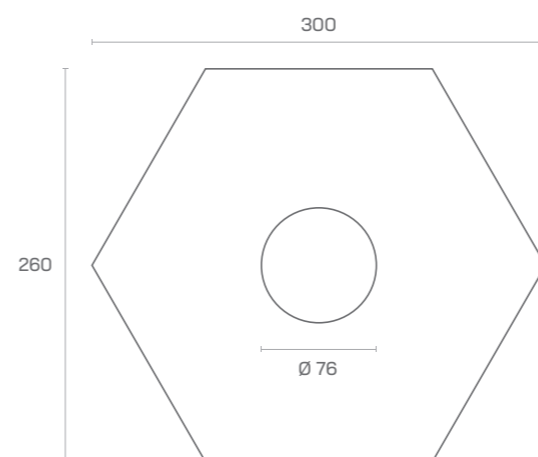

### FINITURE FINISHINGS

#### GALVANIZZATE GALVANIC

-  -OT  
ottone brass
-  -BZ  
bronzo bronze
-  -TI  
titanio titanium
-  -BR  
brunito burnished
-  -CF  
c. di fucile metalgun

#### GRAFITE GRAPHITE

-  -BI  
bianco white
-  -NE  
nero black
-  -CO  
corten corten

unità di misura - unit of measurement: mm

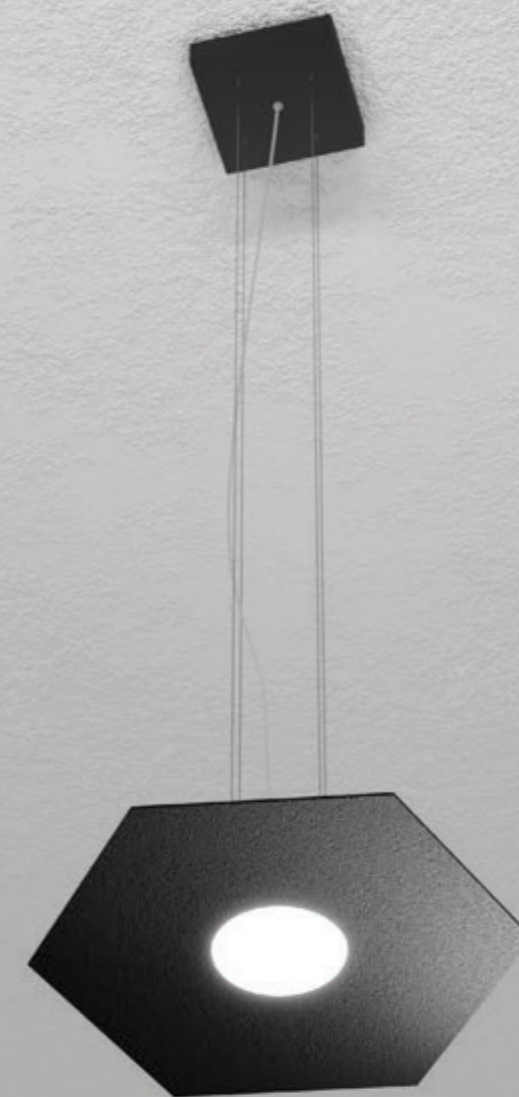

SLIM  
SOSPENSIONI  
PENDANTS

### OPZIONI OPTIONS

#### LAMPADINA BULB

3000K -XLN  
4000K -XLF  
6,5W - 220V - 700lm - CRI >90Ra

## SOSPENSIONE PENDANT CARD x1

SS411

cavo e tiranti  
cable and tie rods  
2m

rosone - ceiling rose  
100mm - 100mm - 27mm

fascio di luce  
light beam  
110°

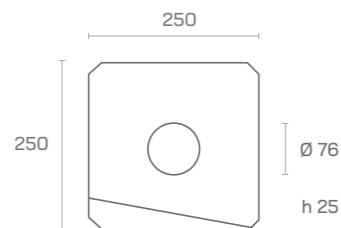

### FINITURE FINISHINGS

GX53  
non inclusa  
not included

#### GALVANIZZATE GALVANIC

-OT  
ottone brass

-BZ  
bronzo bronze

-TI  
titanio titanium

-BR  
brunito burnished

-CF  
c. di fucile metalgun

#### GRAFITE GRAPHITE

-BI  
bianco white

-NE  
nero black

-CO  
corten corten

unità di misura - unit of measurement: mm

### OPZIONI OPTIONS

#### LAMPADINA BULB

3000K -XLN  
4000K -XLF  
6,5W - 220V - 700lm - CRI >90Ra

## SOSPENSIONE PENDANT CARD x3

SS413

cavo e tiranti  
cable and tie rods  
2m

rosone - ceiling rose  
100mm - 100mm - 27mm

fascio di luce  
light beam  
110°

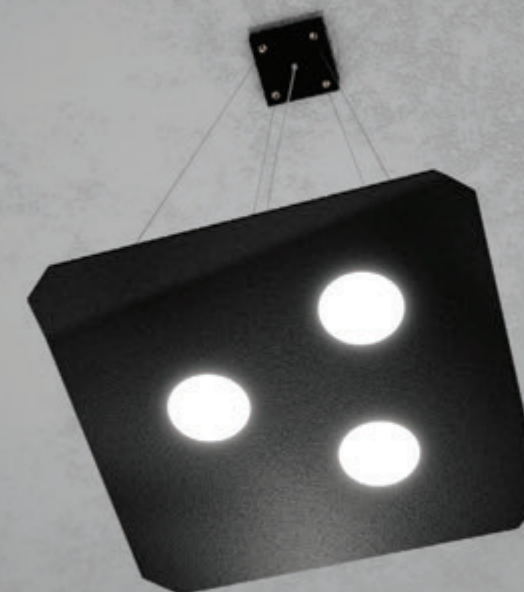
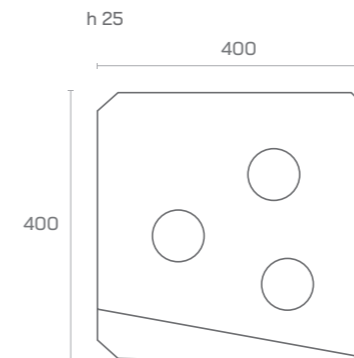

### FINITURE FINISHINGS

GX53  
non inclusa  
not included

#### GALVANIZZATE GALVANIC

-OT  
ottone brass

-BZ  
bronzo bronze

-TI  
titanio titanium

-BR  
brunito burnished

-CF  
c. di fucile metalgun

#### GRAFITE GRAPHITE

-BI  
bianco white

-NE  
nero black

-CO  
corten corten

unità di misura - unit of measurement: mm

### OPZIONI OPTIONS

#### LAMPADINA BULB

3000K -XLN  
4000K -XLF  
6,5W - 220V - 700lm - CRI >90Ra

## SOSPENSIONE PENDANT CARD x2

SS412

cavo e tiranti  
cable and tie rods  
2m

rosone - ceiling rose  
100mm - 100mm - 27mm

fascio di luce  
light beam  
110°

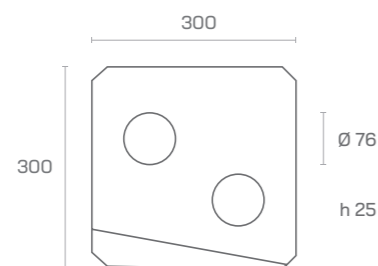

### FINITURE FINISHINGS

GX53  
non inclusa  
not included

#### GALVANIZZATE GALVANIC

-OT  
ottone brass

-BZ  
bronzo bronze

-TI  
titanio titanium

-BR  
brunito burnished

-CF  
c. di fucile metalgun

#### GRAFITE GRAPHITE

-BI  
bianco white

-NE  
nero black

-CO  
corten corten

unità di misura - unit of measurement: mm

### OPZIONI OPTIONS

#### LAMPADINA BULB

3000K -XLN  
4000K -XLF  
6,5W - 220V - 700lm - CRI >90Ra

## SOSPENSIONE PENDANT CARD x4

SS414

cavo e tiranti  
cable and tie rods  
2m

rosone - ceiling rose  
100mm - 100mm - 27mm

fascio di luce  
light beam  
110°

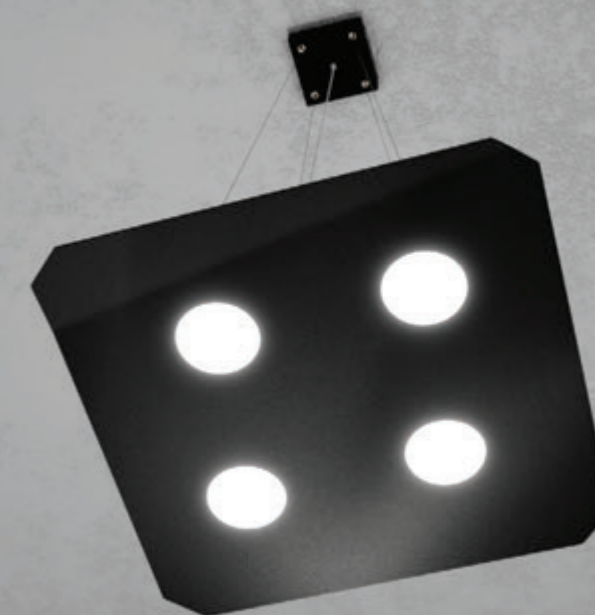
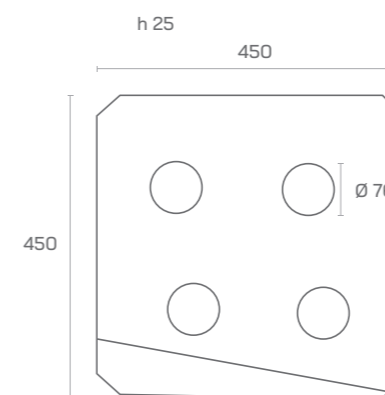

### FINITURE FINISHINGS

GX53  
non inclusa  
not included

#### GALVANIZZATE GALVANIC

-OT  
ottone brass

-BZ  
bronzo bronze

-TI  
titanio titanium

-BR  
brunito burnished

-CF  
c. di fucile metalgun

#### GRAFITE GRAPHITE

-BI  
bianco white

-NE  
nero black

-CO  
corten corten

unità di misura - unit of measurement: mm

### OPZIONI OPTIONS

#### LAMPADINA BULB

3000K -XLN  
4000K -XLF  
6,5W - 220V - 700lm - CRI >90Ra

## SOSPENSIONE PENDANT POIS x1

SS011

cavo e tiranti  
cable and tie rods  
2m

rosone - ceiling rose  
Ø 100mm - 27mm

fascio di luce  
light beam  
110°

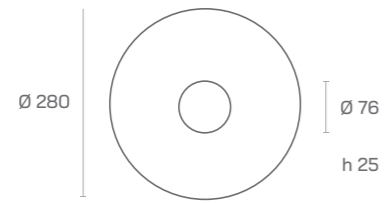

### FINITURE FINISHINGS

GX53  
non inclusa  
not included

#### GALVANIZZATE GALVANIC

-OT  
ottone brass

-BZ  
bronzo bronze

-TI  
titanio titanium

-BR  
brunito burnished

-CF  
c. di fucile metalgun

#### GRAFITE GRAPHITE

-BI  
bianco white

-NE  
nero black

-CO  
corten corten

### OPZIONI OPTIONS

### LAMPADINA BULB

3000K -XLN  
4000K -XLF  
6,5W - 220V - 700lm - CRI >90Ra

unità di misura - unit of measurement: mm

## SOSPENSIONE PENDANT POIS x2

SS012

cavo e tiranti  
cable and tie rods  
2m

rosone - ceiling rose  
Ø 100mm - 27mm

fascio di luce  
light beam  
110°

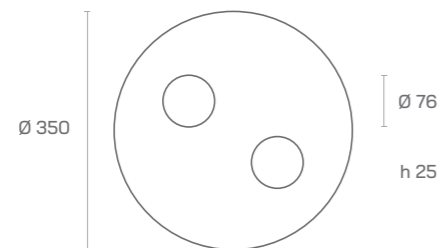

### FINITURE FINISHINGS

GX53  
non inclusa  
not included

#### GALVANIZZATE GALVANIC

-OT  
ottone brass

-BZ  
bronzo bronze

-TI  
titanio titanium

-BR  
brunito burnished

-CF  
c. di fucile metalgun

#### GRAFITE GRAPHITE

-BI  
bianco white

-NE  
nero black

-CO  
corten corten

### OPZIONI OPTIONS

### LAMPADINA BULB

3000K -XLN  
4000K -XLF  
6,5W - 220V - 700lm - CRI >90Ra

unità di misura - unit of measurement: mm

## SOSPENSIONE PENDANT POIS x3

SS013

cavo e tiranti  
cable and tie rods  
2m

rosone - ceiling rose  
Ø 100mm - 27mm

fascio di luce  
light beam  
110°

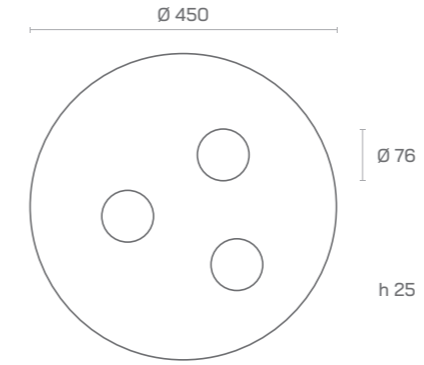

### FINITURE FINISHINGS

GX53  
non inclusa  
not included

#### GALVANIZZATE GALVANIC

-OT  
ottone brass

-BZ  
bronzo bronze

-TI  
titanio titanium

-BR  
brunito burnished

-CF  
c. di fucile metalgun

#### GRAFITE GRAPHITE

-BI  
bianco white

-NE  
nero black

-CO  
corten corten

### OPZIONI OPTIONS

### LAMPADINA BULB

3000K -XLN  
4000K -XLF  
6,5W - 220V - 700lm - CRI >90Ra

unità di misura - unit of measurement: mm

## SOSPENSIONE PENDANT POIS x4

SS014

cavo e tiranti  
cable and tie rods  
2m

rosone - ceiling rose  
Ø 100mm - 27mm

fascio di luce  
light beam  
110°

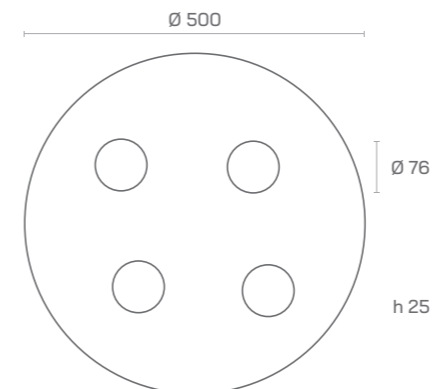

### FINITURE FINISHINGS

GX53  
non inclusa  
not included

#### GALVANIZZATE GALVANIC

-OT  
ottone brass

-BZ  
bronzo bronze

-TI  
titanio titanium

-BR  
brunito burnished

-CF  
c. di fucile metalgun

#### GRAFITE GRAPHITE

-BI  
bianco white

-NE  
nero black

-CO  
corten corten

### OPZIONI OPTIONS

### LAMPADINA BULB

3000K -XLN  
4000K -XLF  
6,5W - 220V - 700lm - CRI >90Ra

unità di misura - unit of measurement: mm





La perfezione si completa con la serie dei  
faretti da incasso con attacco GU10.  
Tutti nella versione verniciata  
a Grafite o Galvanizzata,  
con lampadina a filo o recessa.  
FLAT: versatile e discreto.  
Perfection is completed with the series  
of recessed spotlights with GU10 socket.  
All in the Graphite painted or Galvanized  
version, with flush or recessed light bulb.  
FLAT: versatile and discreet.

# FLAT

A FILO FLAT

RECESSO RECESSED BULB

BASCULANTE SWINGING

## A FILO FLAT ROUND

FF018

GU10  
non inclusa  
not included

fascio di luce  
light beam  
60°



### FINITURE FINISHINGS

#### GALVANIZZATE GALVANIC

-OT  
ottone brass

-BZ  
bronzo bronze

-TI  
titanio titanium

-BR  
brunito burnished

-CF  
c. di fucile metalgun

#### GRAFITE GRAPHITE

-BI  
bianco white

-NE  
nero black

-CO  
corten corten

unità di misura - unit of measurement: mm



### OPZIONI OPTIONS

#### LAMPADINA BULB

2700K -GLC  
4000K -GLF  
3000K -GLN DEFAULT  
6W - 220V - 594lm - CRI >90Ra

2700K -GPC  
4000K -GPF  
3000K -GPN  
12W - 220V - 950lm - CRI >90Ra



## RECESSO RECESSED BULB ROUND

FR019

GU10  
non inclusa  
not included

fascio di luce  
light beam  
60°

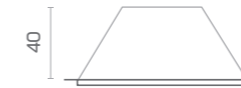

### FINITURE FINISHINGS

#### GALVANIZZATE GALVANIC

-OT  
ottone brass

-BZ  
bronzo bronze

-TI  
titanio titanium

-BR  
brunito burnished

-CF  
c. di fucile metalgun

#### GRAFITE GRAPHITE

-BI  
bianco white

-NE  
nero black

-CO  
corten corten

unità di misura - unit of measurement: mm



### OPZIONI OPTIONS

#### LAMPADINA BULB

2700K -GLC  
4000K -GLF  
3000K -GLN DEFAULT  
6W - 220V - 594lm - CRI >90Ra

2700K -GPC  
4000K -GPF  
3000K -GPN  
12W - 220V - 950lm - CRI >90Ra

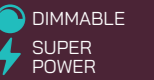

## A FILO FLAT SQUARE

FF418

GU10  
non inclusa  
not included

fascio di luce  
light beam  
60°

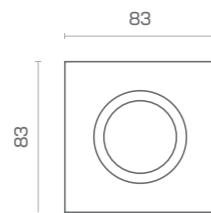

### FINITURE FINISHINGS

#### GALVANIZZATE GALVANIC

-OT  
ottone brass

-BZ  
bronzo bronze

-TI  
titanio titanium

-BR  
brunito burnished

-CF  
c. di fucile metalgun

#### GRAFITE GRAPHITE

-BI  
bianco white

-NE  
nero black

-CO  
corten corten

unità di misura - unit of measurement: mm



### OPZIONI OPTIONS

#### LAMPADINA BULB

2700K -GLC  
4000K -GLF  
3000K -GLN DEFAULT  
6W - 220V - 594lm - CRI >90Ra

2700K -GPC  
4000K -GPF  
3000K -GPN  
12W - 220V - 950lm - CRI >90Ra



## RECESSO RECESSED BULB SQUARE

FR419

GU10  
non inclusa  
not included

fascio di luce  
light beam  
60°



### FINITURE FINISHINGS

#### GALVANIZZATE GALVANIC

-OT  
ottone brass

-BZ  
bronzo bronze

-TI  
titanio titanium

-BR  
brunito burnished

-CF  
c. di fucile metalgun

#### GRAFITE GRAPHITE

-BI  
bianco white

-NE  
nero black

-CO  
corten corten

unità di misura - unit of measurement: mm



### OPZIONI OPTIONS

#### LAMPADINA BULB

2700K -GLC  
4000K -GLF  
3000K -GLN DEFAULT  
6W - 220V - 594lm - CRI >90Ra

2700K -GPC  
4000K -GPF  
3000K -GPN  
12W - 220V - 950lm - CRI >90Ra

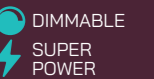

## BASCULANTE SWINGING ROUND

FB019

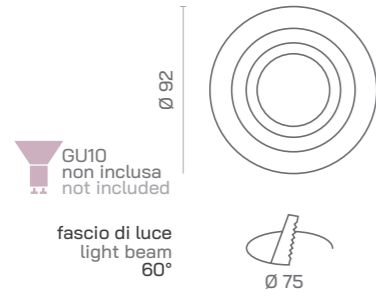

### FINITURE FINISHINGS

#### GALVANIZZATE GALVANIC

- OT ottone brass
- BZ bronzo bronze
- TI titanio titanium
- BR brunito burnished
- CF c. di fucile metalgun

#### GRAFITE GRAPHITE

- BI bianco white
- NE nero black
- CO corten corten

unità di misura - unit of measurement: mm



### OPZIONI OPTIONS

#### LAMPADINA BULB

2700K -GLC  
4000K -GLF  
3000K -GLN DEFAULT  
6W - 220V - 594lm - CRI >90Ra

2700K -GPC  
4000K -GPF  
3000K -GPN  
12W - 220V - 950lm - CRI >90Ra



## BASCULANTE SWINGING SQUARE x2

FB429

### FINITURE FINISHINGS

#### GALVANIZZATE GALVANIC

- OT ottone brass
- BZ bronzo bronze
- TI titanio titanium
- BR brunito burnished
- CF c. di fucile metalgun

#### GRAFITE GRAPHITE

- BI bianco white
- NE nero black
- CO corten corten

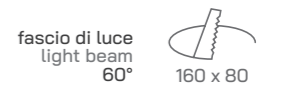
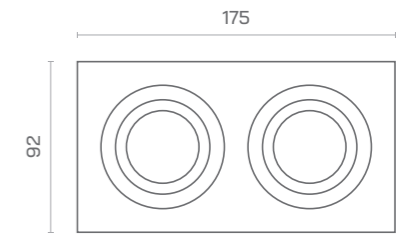

unità di misura - unit of measurement: mm



## BASCULANTE SWINGING SQUARE

FB419

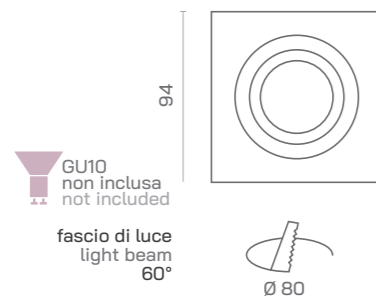

### FINITURE FINISHINGS

#### GALVANIZZATE GALVANIC

- OT ottone brass
- BZ bronzo bronze
- TI titanio titanium
- BR brunito burnished
- CF c. di fucile metalgun

#### GRAFITE GRAPHITE

- BI bianco white
- NE nero black
- CO corten corten

unità di misura - unit of measurement: mm



### OPZIONI OPTIONS

#### LAMPADINA BULB

2700K -GLC  
4000K -GLF  
3000K -GLN DEFAULT  
6W - 220V - 594lm - CRI >90Ra

2700K -GPC  
4000K -GPF  
3000K -GPN  
12W - 220V - 950lm - CRI >90Ra



### OPZIONI OPTIONS

#### LAMPADINA BULB

2700K -GLC  
4000K -GLF  
3000K -GLN DEFAULT  
6W - 220V - 594lm - CRI >90Ra

2700K -GPC  
4000K -GPF  
3000K -GPN  
12W - 220V - 950lm - CRI >90Ra





Elements è un contatto diretto con la natura. La luce, elemento astratto, diventa materia in contrasto con gli elementi di cui la vita è origine. Acqua, aria, terra, fuoco e il nostro quinto elemento... la luce!

Elements represent a direct contact with nature. Light, an abstract element, becomes material in contrast with the elements of which life is origin. Water, air, earth, fire and our fifth element... light

# ELEMENTS

SOSPENSIONI PENDANTS



QUADRATO SQUARE  
TERRA  
ORO GOLD

| EL260

peso  
weight  
5,3kg

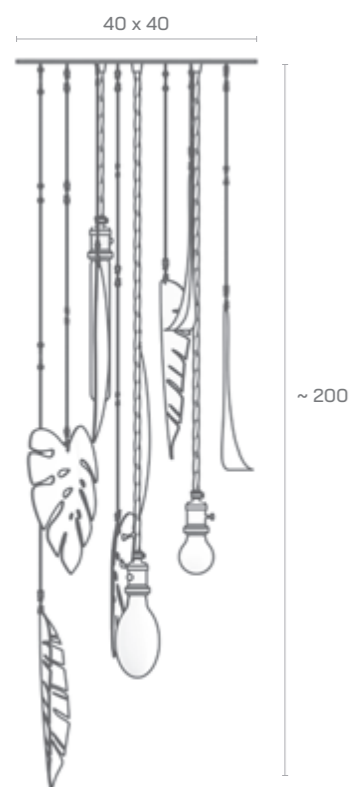

 lampadine  
non include  
bulbs  
not included

unità di misura - unit of measurement: cm



QUADRATO SQUARE  
TERRA  
NERO BLACK

| EL261

peso  
weight  
5,3kg

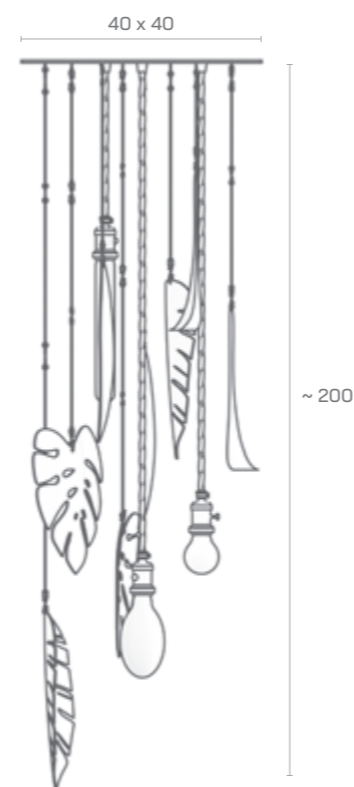

 lampadine  
non include  
bulbs  
not included

unità di misura - unit of measurement: cm



TONDO ROUND  
TERRA  
RAME COPPER

EL263

peso  
weight  
1,2kg

lampadine  
non include  
bulbs  
not included

TONDO ROUND  
ARIA  
ORO GOLD

EL265

peso  
weight  
1,2kg

lampadine  
non include  
bulbs  
not included

TONDO ROUND  
ACQUA  
NERO BLACK

EL264

peso  
weight  
1,2kg

lampadine  
non include  
bulbs  
not included

TONDO ROUND  
FUOCO  
RAME COPPER

EL266

peso  
weight  
1,2kg

lampadine  
non include  
bulbs  
not included

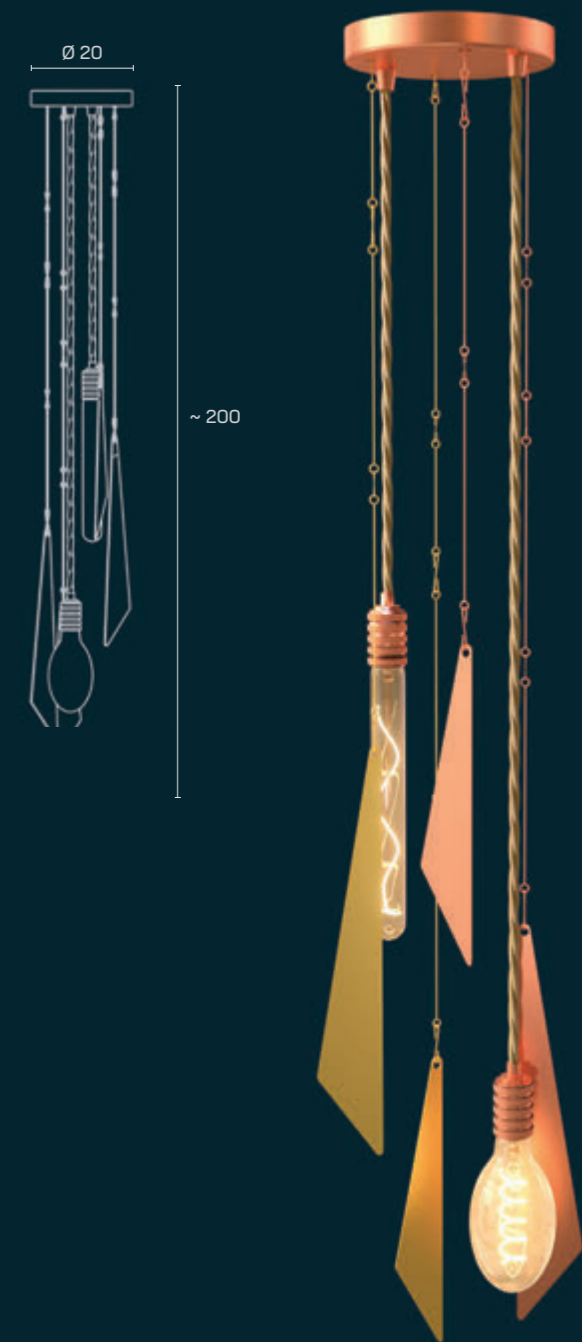
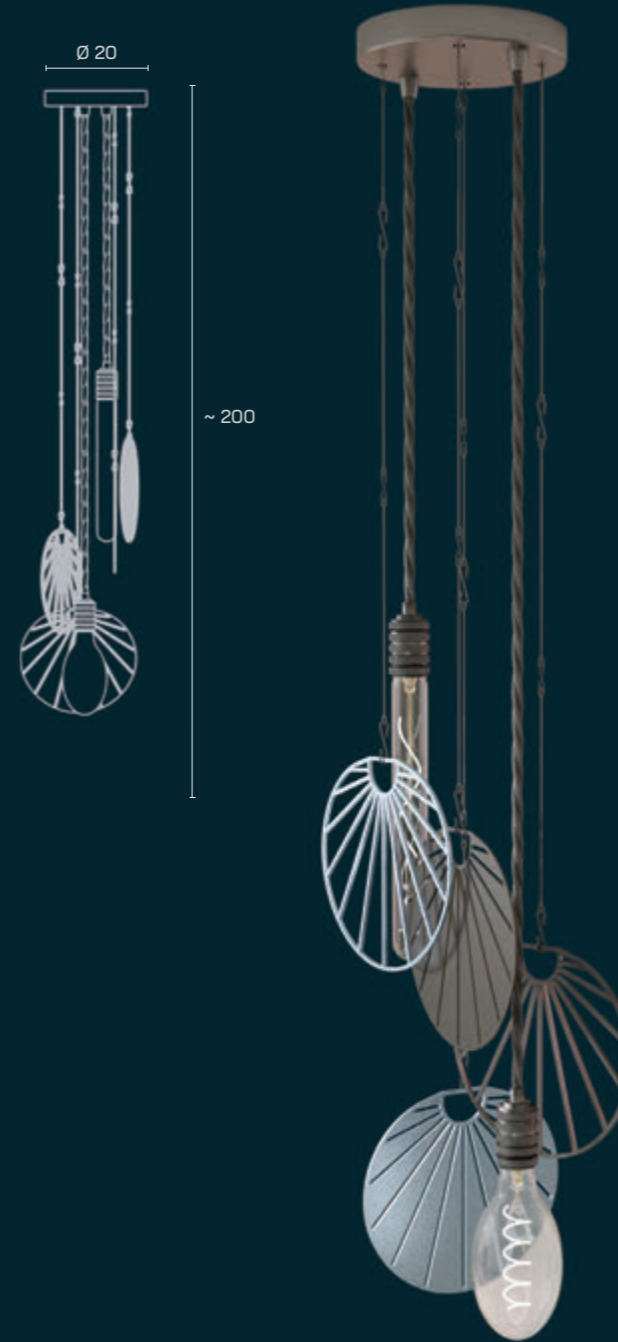
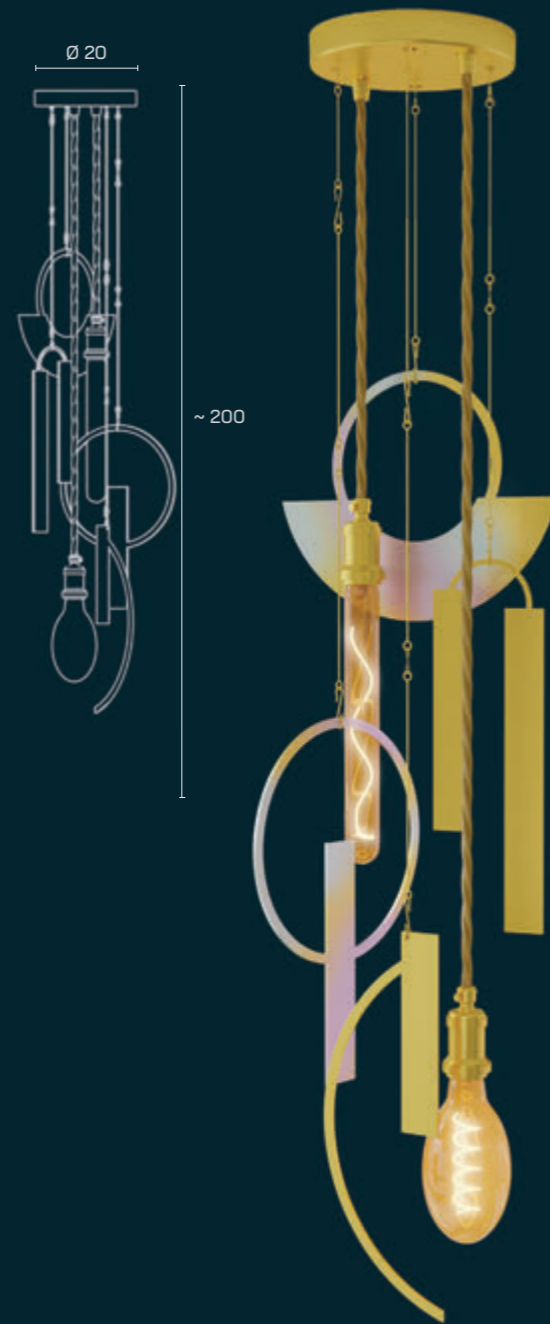
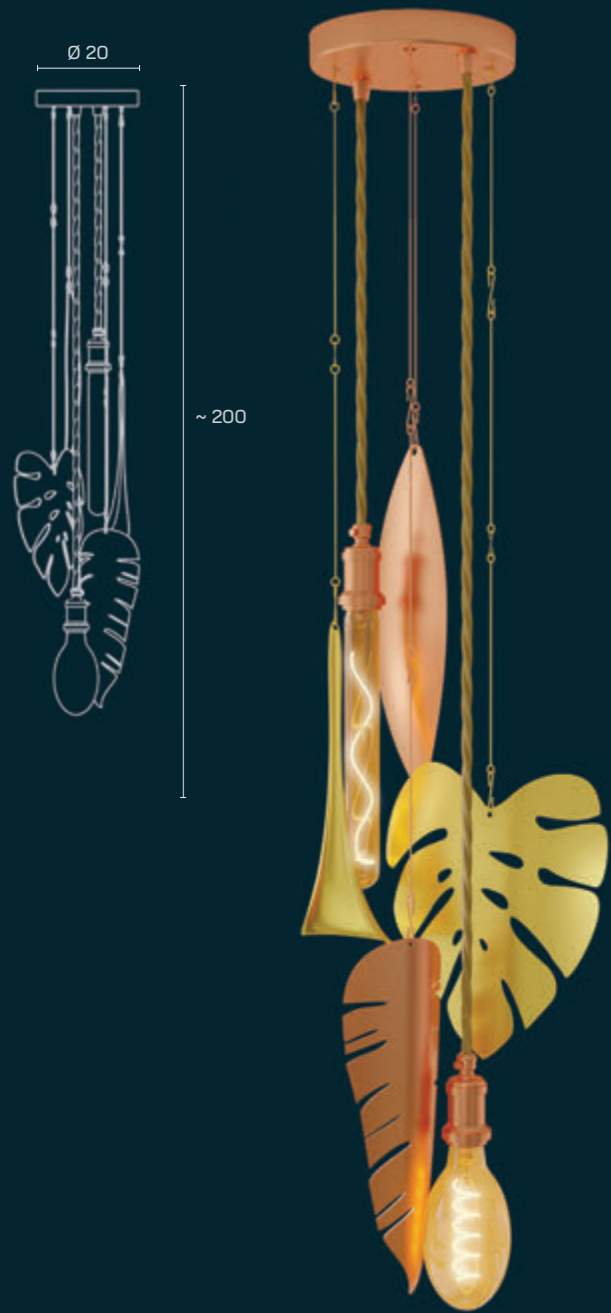

unità di misura - unit of measurement: cm

Ecco la sintesi della luce, il marmo, direttamente dalle cave toscane, ideali per bagni e cucine, le Ruote a caduta su saloni dai soffitti alti, le applique fisse o basculanti della serie Sampei per portare la luce ovunque, le funi, il rustico e le argille per il materico

Here is the synthesis of light, the marble, directly from the Tuscan quarries, ideal for bathrooms and kitchens, the drop-down wheels on high-ceilinged halls, the fixed or tilting wall lamps of the Sampei series to bring light everywhere, the ropes the rustic and the clay for the material



# INDUSTRIAL

MARMO  
RUOTA  
SAMPEI  
BELLS  
ROPE  
ROCKYPAPER

## MARMO NERO

### FINITURE FINISHINGS

GALVANIZZATE  
GALVANIC



	ottone brass	AM703
	oro gold	AM704
	titanio titanium	AM702

peso  
weight  
1,4kg

## MARMO BIANCO

### FINITURE FINISHINGS

GALVANIZZATE  
GALVANIC

	ottone brass	AM701
	oro bronze	AM700
	titanio titanium	AM705

peso  
weight  
1,4kg

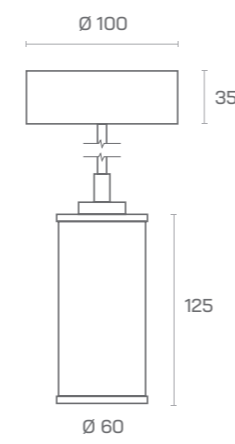

unità di misura - unit of measurement: mm

## INDUSTRIAL MARMO

# RUOTA ELICA

AM115

peso  
weight  
6,8kg

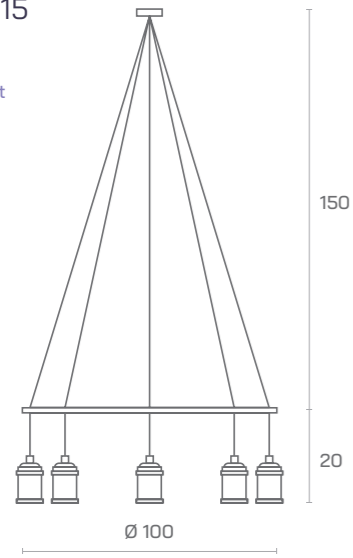

lampadine  
non include  
bulbs  
not included

## FINITURE FINISHINGS

### GALVANIZZATE GALVANIC

-  -OT  
ottone brass
-  -BZ  
bronzo bronze
-  -TI  
titanio titanium
-  -BR  
brunito burnished
-  -CF  
c. di fucile metalgun

### GRAFITE GRAPHITE

-  -BI  
bianco white
-  -NE  
nero black
-  -CO  
corten corten

unità di misura - unit of measurement: cm



# RUOTA VORTICE

AM114

peso  
weight  
6,8kg

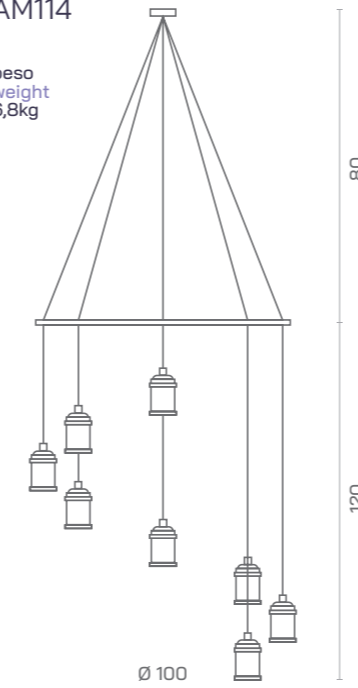

lampadine  
non include  
bulbs  
not included

## FINITURE FINISHINGS

### GALVANIZZATE GALVANIC

-  -OT  
ottone brass
-  -BZ  
bronzo bronze
-  -TI  
titanio titanium
-  -BR  
brunito burnished
-  -CF  
c. di fucile metalgun

### GRAFITE GRAPHITE

-  -BI  
bianco white
-  -NE  
nero black
-  -CO  
corten corten

unità di misura - unit of measurement: cm



INDUSTRIAL  
RUOTA



# SAMPEI FIXED

## DRITTA STRAIGHT AP110

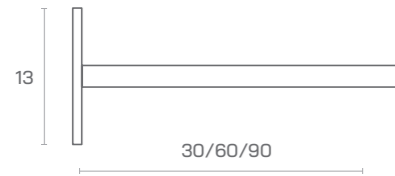

## INCLINATA INCLINED AP113

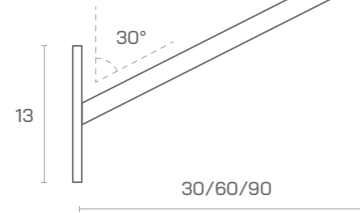

peso  
weight  
2,1kg

## LUNGHEZZA SUPPORTO SUPPORT LENGHT

-30 -60 -90  
30cm 60cm 60cm

## FINITURE FINISHINGS

### GALVANIZZATE GALVANIC

-  -OT  
ottone brass
-  -BZ  
bronzo bronze
-  -TI  
titanio titanium
-  -BR  
brunito burnished
-  -CF  
c. di fucile metalgun

### GRAFITE GRAPHITE

-  -BI  
bianco white
-  -NE  
nero black
-  -CO  
corten corten

unità di misura - unit of measurement: cm



# SAMPEI SWINGING

## AP139

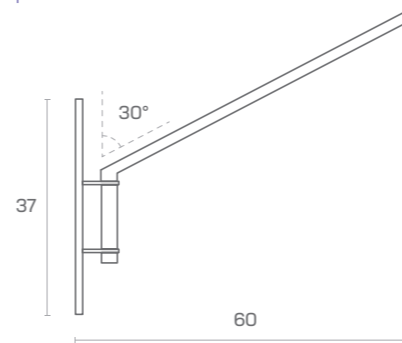

peso  
weight  
2,1kg

## FINITURE FINISHINGS

### GALVANIZZATE GALVANIC

-  -OT  
ottone brass
-  -BZ  
bronzo bronze
-  -TI  
titanio titanium
-  -BR  
brunito burnished
-  -CF  
c. di fucile metalgun

### GRAFITE GRAPHITE

-  -BI  
bianco white
-  -NE  
nero black
-  -CO  
corten corten

unità di misura - unit of measurement: cm





## INDUSTRIAL ROPE

lampadine  
non include  
bulbs  
not included

### BELLS STEEL

CA307

lampadario a sospensione 2m  
campana in metallo martellata a mano  
colore acciaio  
portalampada E27 in metallo rame  
rosone rame Ø 10cm h 3,5cm  
cavo tondo 3x0,75 canvas beige  
2m hanging chandelier  
hand hammered metal bell - steel color  
E27 copper lamp holder  
copper ceiling rose Ø 10cm h 3,5cm  
3x0,75 canvas beige round cable  
Ø 39cm h 21cm

### BELLS BRASS

CA306

lampadario a sospensione 2m  
campana in metallo martellata a mano  
colore ottone  
portalampada E27 in metallo canna di fucile  
rosone nero Ø 10cm h 3,5cm  
cavo tondo 3x0,75 nero  
2m hanging chandelier  
hand hammered metal bell - brass color  
E27 gunmetal lamp holder  
gunmetal ceiling rose Ø 10cm h 3,5cm  
3x0,75 black round cable  
Ø 39cm h 21cm

### BELLS BRONZE

CA305

lampadario a sospensione 2m  
campana in metallo martellata a mano  
colore bronzo  
portalampada E27 in metallo canna di fucile  
rosone canna di fucile Ø 10cm h 3,5cm  
cavo tondo 3x0,75 nero  
2m hanging chandelier  
hand hammered metal bell - bronze color  
E27 gunmetal lamp holder  
gunmetal ceiling rose Ø 10cm h 3,5cm  
3x0,75 black round cable  
Ø 39cm h 21cm

### BELLS WHITE

CA301

lampadario a sospensione 2m  
campana in metallo colore bianco  
portalampada E27 in metallo  
canna di fucile  
rosone bianco Ø 10cm h 3,5cm  
cavo tondo 3x0,75 bianco  
2m hanging chandelier  
metal bell in white color  
E27 gunmetal lamp holder  
white ceiling rose Ø 10cm h 3,5cm  
3x0,75 white round cable  
Ø 31cm h 17cm



### BELLS BRITISH

CA308

lampadario a sospensione 2m  
campana in metallo verde con griglia  
portalampada E27  
rosone nero Ø 10cm h 3,5cm  
cavo in pvc 3x0,75 nero  
2m hanging chandelier  
green metal bell with grill  
E27 lamp holder  
black ceiling rose Ø 10cm h 3,5cm  
3x0,75 black pvc cable  
Ø 33cm h 18cm



## INDUSTRIAL BELLS

lampadina  
non inclusa  
bulb  
not included



### ROPE UNO

CA319

lampadario a sospensione 2m  
funne navale con un portalampada E27  
rosone nero Ø 10cm h 3,5cm  
certificato in Italia con prove di sicurezza termica  
hanging chandelier  
naval rope with one E27 lamp holder  
black ceiling rose Ø 10cm h 3,5cm  
certified in Italy with thermal safety tests



### ROPE DUE

CA320

lampadario a sospensione 2m  
funne navale con due portalampada E27  
rosone nero Ø 10cm h 3,5cm  
certificato in Italia con prove di sicurezza termica  
hanging chandelier  
naval rope with two E27 lamp holders  
black ceiling rose Ø 10cm h 3,5cm  
certified in Italy with thermal safety tests



### ROPE SEI

CA321

lampadario a sospensione 2m  
funne navale con sei portalampada E27  
rosone nero Ø 10cm h 3,5cm  
certificato in Italia con prove di sicurezza termica  
hanging chandelier  
naval rope with six E27 lamp holders  
black ceiling rose Ø 10cm h 3,5cm  
certified in Italy with thermal safety tests

ROCKYPAPER  
GOLD  
SHELL

AM101

lampadario a sospensione 2m - campana rockypaper colore oro  
foro 3cm - rosone oro Ø 100mm h 35mm  
cavo tondo 3x0,75 canvas marrone  
2m hanging chandelier - rockypaper bell in gold color  
hole 3cm - gold ceiling rose Ø 10cm h 3,5cm  
3x0,75 canvas brown round cable  
Ø 300mm h 100mm

ROCKYPAPER  
BLACKBOARD  
SHELL

AM102

lampadario a sospensione 2m - campana rockypaper colore carbone  
foro 3cm - rosone canna di fucile Ø 100mm h 35mm  
cavo tondo 3x0,75 nero cotone  
2m hanging chandelier - rockypaper bell in carbon color  
hole 3cm - gunmetal ceiling rose Ø 10cm h 3,5cm  
3x0,75 black cotton round cable  
Ø 300mm h 100mm

ROCKYPAPER  
CARBON  
CALIMERO

AM103

lampadario a sospensione 2m - cupola calimero rockypaper colore carbone  
foro 3cm - rosone nero Ø 100mm h 35mm  
cavo tondo 2x0,75 nero cotone  
2m hanging chandelier - dome calimero rockypaper in carbon color  
hole 3cm - black ceiling rose Ø 100mm h 350m  
2x0,75 black cotton round cable  
Ø 300mm h 270mm

ROCKYPAPER  
ALHAMBRA  
CALIMERO

AM104

lampadario a sospensione 2m - cupola calimero rockypaper colore cream  
foro 3cm - rosone bianco Ø 100mm h 35mm  
cavo tondo 2x0,75 canvas beige  
2m hanging chandelier - dome calimero rockypaper in beige color  
hole 3cm - white ceiling rose Ø 100mm h 350m  
2x0,75 canvas beige round cable  
Ø 300mm h 270mm



lampadina  
non inclusa  
bulb  
not included

INDUSTRIAL  
ROCKYPAPER

ROCKYPAPER  
ALHAMBRA

AT541

pendente assemblato 2m  
portalampada rockypaper rounded E27  
colore cemento cream  
rosone bianco Ø 100mm h 35mm  
cavo tondo 2x0,75 canvas beige  
2m lamp holder  
E27 rockypaper rounded  
lamp holder in cement cream color  
white ceiling rose Ø 100mm h 35mm  
2x0,75 canvas beige round cable  
h 100mm Ø 60mm



ROCKYPAPER  
CARBON

AT542

pendente assemblato 2m  
portalampada rockypaper rounded E27  
colore carbone  
rosone nero Ø 100mm h 35mm  
cavo tondo 2x0,75 nero cotone  
2m lamp holder  
E27 rockypaper rounded  
lamp holder in carbon color  
black ceiling rose Ø 100mm h 35mm  
2x0,75 black round cable  
h 100mm Ø 60mm



ROCKYPAPER  
CONCRETE L

AT544

pendente assemblato 2m  
portalampada rockypaper rettangolo E27  
colore cemento grigio  
rosone nero Ø 100mm h 35mm  
cavo tondo 2x0,75 canvas grigio chiaro  
2m lamp holder  
E27 rockypaper squared  
lamp holder in cement grey color  
black ceiling rose Ø 100mm h 35mm  
2x0,75 light gray canvas round cable  
h 150mm l 105mm



ROCKYPAPER  
CONCRETE S

AT540

pendente assemblato 2m  
portalampada rockypaper rettangolo E27  
colore cemento grigio  
rosone nero Ø 100mm h 35mm  
cavo tondo 2x0,75 canvas grigio chiaro  
2m lamp holder  
E27 rockypaper squared  
lamp holder in cement grey color  
black ceiling rose Ø 100mm h 35mm  
2x0,75 light gray canvas round cable  
h 100mm l 60mm



COMPONENTI  
COMPONENTS



LAMPADINE  
BULBS



LAMPADINE  
CARBONIO  
CARBON BULBS

**AV162**  
E27  
30W  
<60 lm  
2000K  
energy class E  
vetro ambrato  
amber glass  
dimmerabile  
dimmmabile  
h 340mm  
Ø 165mm



**AV452**  
E27  
25W  
<60 lm  
2000K  
energy class E  
vetro ambrato  
amber glass  
dimmerabile  
dimmmabile  
h 83mm  
Ø 45mm



**AV952**  
E27  
25W  
<60 lm  
2000K  
energy class E  
vetro ambrato  
amber glass  
dimmerabile  
dimmmabile  
h 113mm  
Ø 95mm



**AV112**  
E27  
25W  
<60 lm  
2000K  
energy class E  
vetro ambrato  
amber glass  
dimmerabile  
dimmmabile  
h 141mm  
Ø 125mm

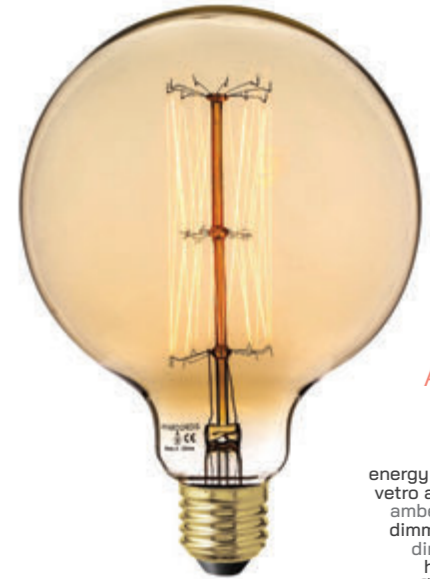

**AV752**  
E27  
25W  
<60 lm  
2000K  
energy class E  
vetro ambrato  
amber glass  
dimmerabile  
dimmmabile  
h 133mm  
Ø 75mm

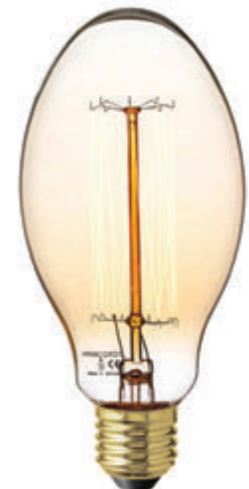

**AV802**  
E27  
25W  
<60 lm  
2000K  
energy class E  
vetro ambrato  
amber glass  
dimmerabile  
dimmmabile  
h 93mm  
Ø 80mm



LAMPADINE  
LED DIMMERABILI  
DIMMABLE LED BULBS

**DL205**  
E27  
4W  
130 lm  
2000K  
energy class A+  
vetro ambrato  
amber glass  
dimmerabile  
dimmable  
h 340mm  
Ø 200mm



**DL162**  
E27  
4W  
130 lm  
2000K  
energy class A+  
vetro ambrato  
amber glass  
dimmerabile  
dimmable  
h 340mm  
Ø 165mm



**DL306**  
E27  
4W  
130 lm  
2000K  
energy class A+  
vetro ambrato  
amber glass  
dimmerabile  
dimmable  
h 280mm  
Ø 35mm



**DL642**  
E27  
4W  
220 lm  
2000K  
energy class A+  
vetro ambrato  
amber glass  
dimmerabile  
dimmable  
h 121mm  
Ø 64mm



**DL805**  
E27  
4W  
220 lm  
2000K  
energy class A+  
vetro ambrato  
amber glass  
dimmerabile  
dimmable  
h 102mm  
Ø 80mm



**DL165**  
E27  
4W  
130 lm  
2000K  
energy class A+  
vetro ambrato  
amber glass  
dimmerabile  
dimmable  
h 340mm  
Ø 165mm

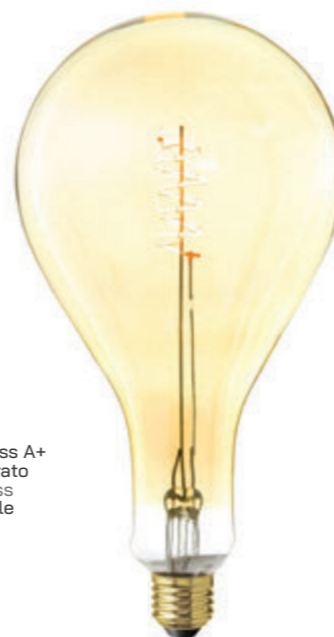

**DL125**  
E27  
4W  
220 lm  
2000K  
energy class A+  
vetro ambrato  
amber glass  
dimmerabile  
dimmable  
h 154mm  
Ø 125mm



**DL755**  
E27  
4W  
130 lm  
2000K  
energy class A+  
vetro ambrato  
amber glass  
dimmerabile  
dimmable  
h 133mm  
Ø 75mm



**DL452**  
E27  
4W  
220 lm  
2000K  
energy class A+  
vetro ambrato  
amber glass  
dimmerabile  
dimmable  
h 83mm  
Ø 45mm



**DL601**  
E27  
4W  
130 lm  
2000K  
energy class A+  
vetro ambrato  
amber glass  
dimmerabile  
dimmable  
h 85mm  
Ø 60mm



**DL357**  
E14  
4W  
170 lm  
2000K  
energy class A+  
vetro ambrato  
amber glass  
dimmerabile  
dimmable  
h 98mm  
Ø 35mm



**DL342**  
E14  
4W  
170 lm  
2000K  
energy class A+  
vetro ambrato  
amber glass  
dimmerabile  
dimmable  
h 80mm  
Ø 34mm





**DL168**  
E27  
12W  
1300 lm  
2700K  
energy class A+  
vetro chiaro  
clear glass  
dimmerabile  
dimmmabile  
h 245mm  
Ø 200mm

**DL120**  
E27  
4W  
130 lm  
2200K  
energy class A+  
vetro chiaro  
clear glass  
dimmerabile  
dimmmabile  
h 145mm  
Ø 125mm



**DL122**  
E27  
4W  
400 lm  
2700K  
energy class A+  
vetro chiaro  
clear glass  
dimmerabile  
dimmmabile  
h 145mm  
Ø 125mm



**DL102**  
E27  
4W  
150 lm  
3000K  
energy class A+  
vetro chiaro  
clear glass  
dimmerabile  
dimmmabile  
h 80mm  
l 450mm



**DL160**  
E27  
12W  
1300 lm  
2700K  
energy class A+  
vetro chiaro  
clear glass  
dimmerabile  
dimmmabile  
h 245mm  
Ø 200mm



**DL167**  
E27  
12W  
1300 lm  
2700K  
energy class A+  
vetro chiaro  
clear glass  
dimmerabile  
dimmmabile  
h 340mm  
Ø 165mm



**DLOVE**  
E27  
4W  
130 lm  
2500K  
energy class A+  
vetro ambrato  
amber glass  
dimmerabile  
dimmmabile  
h 154mm  
Ø 125mm



**DLHOM**  
E27  
4W  
130 lm  
2500K  
energy class A+  
vetro ambrato  
amber glass  
dimmerabile  
dimmmabile  
h 154mm  
Ø 125mm



**DL129**  
E27  
4W  
130 lm  
2500K  
energy class A+  
vetro ambrato  
amber glass  
dimmerabile  
dimmmabile  
h 154mm  
Ø 125mm



**DL130**  
E27  
4W  
130 lm  
2500K  
energy class A+  
vetro ambrato  
amber glass  
dimmerabile  
dimmmabile  
h 154mm  
Ø 125mm





LAMPADINE  
**MASTER CHEF**  
 KITCHEN BULBS



**MC102**  
 E27  
 4W  
 150 lm  
 2700K  
 energy class A+  
 vetro ambrato  
 amber glass  
 dimmerabile  
 dimmable  
 h 154mm  
 Ø 125mm



**MC101**  
 E27  
 4W  
 150 lm  
 2700K  
 energy class A+  
 vetro ambrato  
 amber glass  
 dimmerabile  
 dimmable  
 h 154mm  
 Ø 125mm



**MC100**  
 E27  
 4W  
 150 lm  
 2700K  
 energy class A+  
 vetro ambrato  
 amber glass  
 dimmerabile  
 dimmable  
 h 154mm  
 Ø 125mm



**MC103**  
 E27  
 4W  
 150 lm  
 2700K  
 energy class A+  
 vetro ambrato  
 amber glass  
 dimmerabile  
 dimmable  
 h 154mm  
 Ø 125mm



**MC104**  
 E27  
 4W  
 150 lm  
 2700K  
 energy class A+  
 vetro ambrato  
 amber glass  
 dimmerabile  
 dimmable  
 h 154mm  
 Ø 125mm



LAMPADINE  
**POWER LED**  
 POWER LED BULBS



**AL125**  
 E27  
 7W  
 800 lm  
 2500K  
 vetro ambrato  
 amber glass  
 non dimmerabile  
 not dimmable  
 h 154mm  
 Ø 125mm  
 energy class A++



**AL791**  
 E27  
 6W  
 600 lm  
 2500K  
 vetro ambrato  
 amber glass  
 non dimmerabile  
 not dimmable  
 h 130mm  
 Ø 125mm  
 energy class A++



**AL601**  
 E27  
 7W  
 800 lm  
 2500K  
 vetro ambrato  
 amber glass  
 non dimmerabile  
 not dimmable  
 h 85mm  
 Ø 60mm  
 energy class A++



**AL642**  
 E27  
 7W  
 800 lm  
 2500K  
 vetro ambrato  
 amber glass  
 non dimmerabile  
 not dimmable  
 h 121mm  
 Ø 64mm  
 energy class A++



**LB701**  
 E27  
 6W  
 600 lm  
 3000K  
 vetro chiaro  
 clear glass  
 non dimmerabile  
 not dimmable  
 h 115mm  
 Ø 95mm  
 energy class A++



**LB707**  
 E27  
 4W  
 400 lm  
 3000K  
 vetro chiaro  
 clear glass  
 non dimmerabile  
 not dimmable  
 h 121mm  
 Ø 64mm  
 energy class A++



**LB700**  
 E27  
 6W  
 600 lm  
 3000K  
 vetro chiaro  
 clear glass  
 non dimmerabile  
 not dimmable  
 h 85mm  
 Ø 60mm  
 energy class A++



**LB702**  
 E27  
 4W  
 400 lm  
 3000K  
 vetro chiaro  
 clear glass  
 non dimmerabile  
 not dimmable  
 h 58mm  
 Ø 45mm  
 energy class A++



**LB703**  
 E14  
 4W  
 400 lm  
 3000K  
 vetro chiaro  
 clear glass  
 non dimmerabile  
 not dimmable  
 h 58mm  
 Ø 45mm  
 energy class A++



**LB704**  
 E14  
 4W  
 400 lm  
 3000K  
 vetro chiaro  
 clear glass  
 non dimmerabile  
 not dimmable  
 h 70mm  
 Ø 35mm  
 energy class A++





**DF642**  
E27  
4W  
130 lm  
2200K  
energy class A  
vetro fumé  
smoky glass  
dimmerabile  
dimmmabile  
h 121mm  
Ø 64mm



**DF306**  
E27  
4W  
130 lm  
2200K  
energy class A  
vetro fumé  
smoky glass  
dimmerabile  
dimmmabile  
h 280mm  
Ø 35mm



**DF160**  
E27  
4W  
130 lm  
2200K  
energy class B  
vetro fumé  
smoky glass  
dimmerabile  
dimmmabile  
h 340mm  
Ø 160mm



Patent N. 006083457 002  
**DF100**  
E27  
4W  
230 lm  
2200K  
energy class B  
vetro fumé  
smoky glass  
dimmerabile  
dimmmabile  
h 340mm  
Ø 160mm



**DF125**  
E27  
4W  
130 lm  
2200K  
energy class A  
vetro fumé  
smoky glass  
dimmerabile  
dimmmabile  
h 154mm  
Ø 125mm



**DFUCK**  
E27  
4W  
130 lm  
2200K  
energy class A  
vetro fumé  
smoky glass  
dimmerabile  
dimmmabile  
h 154mm  
Ø 125mm



**DF105**  
E27  
4W  
130 lm  
2200K  
energy class A  
vetro fumé  
smoky glass  
dimmerabile  
dimmmabile  
h 154mm  
Ø 125mm



LAMPADINE  
SMERIGLIATE  
FROSTED BULBS

LAMPADINE  
SMOKEY  
SMOKEY BULBS

**ML707**  
E14  
4W  
300 lm  
2700K  
energy class A++  
vetro smerigliato  
frosted glass  
dimmerabile  
dimmmabile  
h 70mm  
Ø 35mm



**ML703**  
E14  
4W  
360 lm  
2700K  
energy class A++  
vetro smerigliato  
frosted glass  
dimmerabile  
dimmmabile  
h 55mm  
Ø 45mm



**ML601**  
E27  
5W  
400 lm  
2700K  
energy class A++  
vetro smerigliato  
frosted glass  
dimmerabile  
dimmmabile  
h 85mm  
Ø 60mm



**ML640**  
E27  
5W  
300 lm  
2700K  
energy class A++  
vetro smerigliato  
frosted glass  
dimmerabile  
dimmmabile  
h 154mm  
Ø 125mm



**ML125**  
E27  
8W  
600 lm  
2700K  
energy class A++  
vetro smerigliato  
frosted glass  
dimmerabile  
dimmmabile  
h 154mm  
Ø 125mm



LAMPADINE  
COLORED  
COLORED BULBS



LAMPADINE  
GERMAN  
TECHNOLOGY  
BULBS



LB920 bianca white    LB921 gialla yellow    LB922 blu blue    LB923 verde verde    LB925 lilla lilac    LB926 arancione orange

E27 - 5W - 360lm - 2700K - plastica colorata colored plastic - non dimmerabile not immable - h 85mm Ø 60mm - energy class A++



LB910 bianca white    LB911 bianca white    LB912 gialla yellow    LB913 blu blue    LB914 verde verde    LB915 rossa red    LB916 lilla lilac

E27 - 1W - 130lm - 2700K - plastica colorata colored plastic - non dimmerabile not immable - h 45mm Ø 55mm - energy class A++



**DS043**  
 E27  
 6W  
 330 lm  
 1900K  
 Erp G  
 Vetro Chiaro  
 Clear Glass  
 Dimmerabile  
 Dimmable  
 h 110mm  
 Ø 200mm



**DS894**  
 E27  
 14W  
 1550 lm  
 2700K  
 Erp E  
 Vetro Chiaro  
 Clear Glass  
 Dimmerabile  
 Dimmable  
 h 240mm  
 Ø 90mm



**DS396**  
 E27  
 6,5W  
 400 lm  
 1900K  
 Erp G  
 Vetro Chiaro  
 Clear Glass  
 Dimmerabile  
 Dimmable  
 h 300mm  
 Ø 32mm



**DS051**  
 E27  
 6W  
 300 lm  
 1900K  
 Erp G  
 Vetro Chiaro  
 Clear Glass  
 Dimmerabile  
 Dimmable  
 h 90mm  
 Ø 125mm



**DS046**  
 E27  
 6W  
 300 lm  
 1900K  
 Erp G  
 Vetro Chiaro  
 Clear Glass  
 Dimmerabile  
 Dimmable  
 h 165mm  
 Ø 125mm

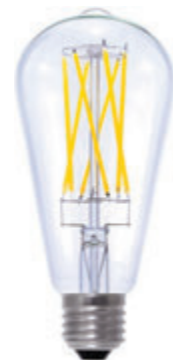

**DS700**  
 E27  
 6,5W  
 650 lm  
 2700K  
 Erp F  
 Vetro Chiaro  
 Clear Glass  
 Dimmerabile  
 Dimmable  
 h 145mm  
 Ø 65mm



**DS689**  
 E27  
 6,5W  
 650 lm  
 2700K  
 Erp F  
 Vetro Chiaro  
 Clear Glass  
 Dimmerabile  
 Dimmable  
 h 235mm  
 Ø 150mm



**DS685**  
 E27  
 6,5W  
 650 lm  
 2700K  
 Erp F  
 Vetro Chiaro  
 Clear Glass  
 Dimmerabile  
 Dimmable  
 h 180mm  
 Ø 125mm



**DS337**  
 E27  
 6,5W  
 650 lm  
 2700K  
 Erp F  
 Vetro Chiaro  
 Clear Glass  
 Dimmerabile  
 Dimmable  
 h 110mm  
 Ø 60mm



**DS805**  
 E27  
 7,5W  
 900 lm  
 2700K  
 Erp E  
 Vetro Chiaro  
 Clear Glass  
 Dimmerabile  
 Dimmable  
 h 110mm  
 Ø 62mm



**DS680**  
 E27  
 6,5W  
 650 lm  
 2700K  
 Erp F  
 Vetro Chiaro  
 Clear Glass  
 Dimmerabile  
 Dimmable  
 h 140mm  
 Ø 95mm



**DS681**  
 E27  
 6,5W  
 650 lm  
 2700K  
 Erp F  
 Vetro Chiaro  
 Clear Glass  
 Dimmerabile  
 Dimmable  
 h 125mm  
 Ø 80mm



## DIM TO WARM



**DS305**  
E27  
6,2W  
460 lm  
2000K - 2700K  
Erp G  
Vetro Chiaro  
Clear Glass  
Dimmerabile  
Dimmable  
h 180mm  
Ø 125mm  
dim to warm



**DS302**  
E27  
6,2W  
460 lm  
2000K - 2700K  
Erp G  
Vetro Chiaro  
Clear Glass  
Dimmerabile  
Dimmable  
h 145mm  
Ø 65mm  
dim to warm



**DS306**  
E27  
3,3W  
200 lm  
2000K - 2700K  
Erp G  
Vetro Chiaro  
Clear Glass  
Dimmerabile  
Dimmable  
h 72mm  
Ø 45mm  
dim to warm



**DS301**  
E27  
6,2W  
460 lm  
2000K - 2700K  
Erp G  
Vetro Chiaro  
Clear Glass  
Dimmerabile  
Dimmable  
h 110mm  
Ø 60mm  
dim to warm



**DS300**  
E14  
3,3W  
200 lm  
2000K - 2700K  
Erp G  
Vetro Chiaro  
Clear Glass  
Dimmerabile  
Dimmable  
h 100mm  
Ø 35mm  
dim to warm



**DS727**  
E27  
6,5W  
480 lm  
2000K - 2700K  
Erp G  
Vetro Opale  
Frosted Glass  
Dimmerabile  
Dimmable  
h 115mm  
Ø 80mm  
dim to warm



**DS248**  
E27  
6,5W  
650 lm  
2000K - 2700K  
Erp F  
Vetro Chiaro  
Clear Glass  
Dimmerabile  
Dimmable  
h 110mm  
Ø 60mm  
dim to warm



## ELEMENTS

# ELEMENTS TERRA

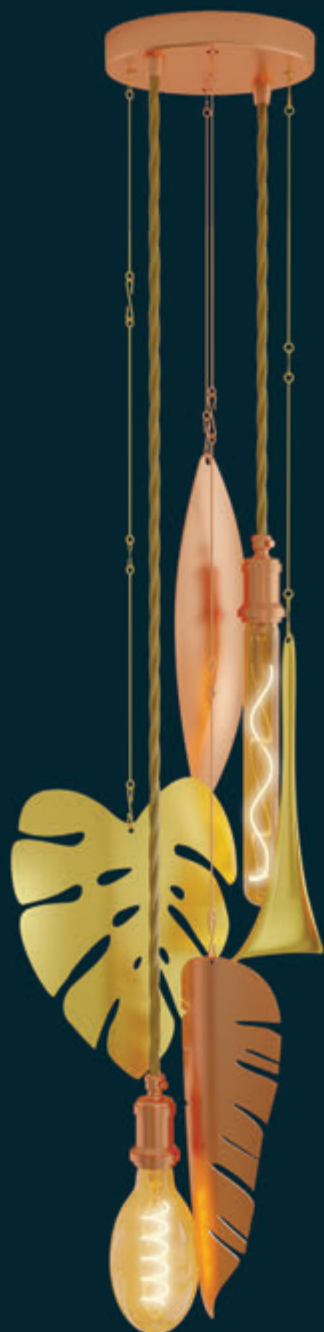

MONSTERA



## FINITURE FINISHINGS

	oro gold	EL101
	oro zincato zinc gold	EL102
	rame copper	EL103
	argento zincato zinc silver	EL104
	titanio titanium	EL105

Decorazione 3D in metallo a taglio laser, spessore 1mm  
Decorative 3d laser-cut metal element, 1mm thick  
100g - h 190mm - l 160mm

BANANA



## FINITURE FINISHINGS

	oro gold	EL111
	oro zincato zinc gold	EL112
	rame copper	EL113
	argento zincato zinc silver	EL114
	titanio titanium	EL115

Decorazione 3D in metallo a taglio laser, spessore 1mm  
Decorative 3d laser-cut metal element, 1mm thick  
100g - h 300mm - l 90mm

BAMBOO



## FINITURE FINISHINGS

	oro gold	EL121
	oro zincato zinc gold	EL122
	rame copper	EL123
	argento zincato zinc silver	EL124
	titanio titanium	EL125

Decorazione 3D in metallo a taglio laser, spessore 1mm  
Decorative 3d laser-cut metal element, 1mm thick  
80g - h 240mm - l 70mm

CALLA



## FINITURE FINISHINGS

	oro gold	EL131
	oro zincato zinc gold	EL132
	rame copper	EL133
	argento zincato zinc silver	EL134
	titanio titanium	EL135

Decorazione 3D in metallo a taglio laser, spessore 1mm  
Decorative 3d laser-cut metal element, 1mm thick  
90g - h 250mm - l 70mm

# ELEMENTS ARIA

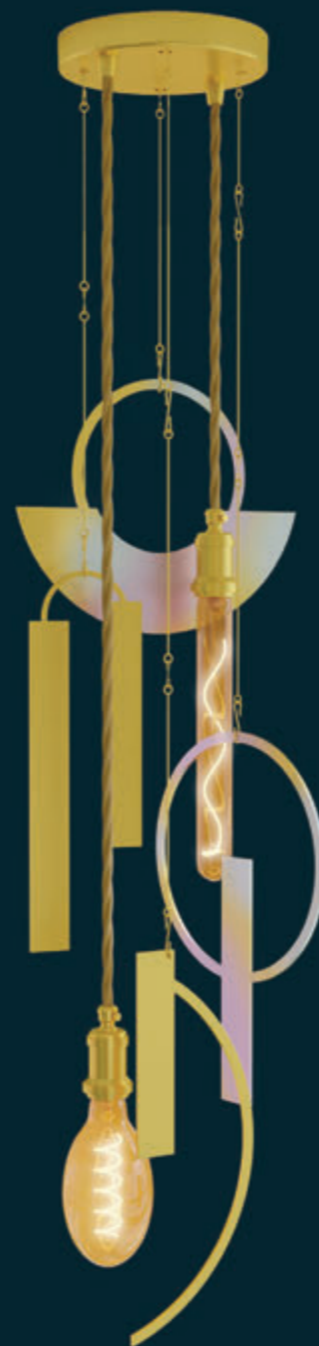

STARGATE



## FINITURE FINISHINGS

	oro gold	EL126
	oro zincato zinc gold	EL127
	rame copper	EL128
	argento zincato zinc silver	EL129
	titanio titanium	EL130

Decorazione 3D in metallo a taglio laser, spessore 1mm  
Decorative 3d laser-cut metal element, 1mm thick  
150g - h 290mm - l 80mm

BREATH



## FINITURE FINISHINGS

	oro gold	EL136
	oro zincato zinc gold	EL137
	rame copper	EL138
	argento zincato zinc silver	EL139
	titanio titanium	EL140

Decorazione 3D in metallo a taglio laser, spessore 1mm  
Decorative 3d laser-cut metal element, 1mm thick  
200g - h 180mm - l 230mm

ECLIPSE



## FINITURE FINISHINGS

	oro gold	EL141
	oro zincato zinc gold	EL142
	rame copper	EL143
	argento zincato zinc silver	EL144
	titanio titanium	EL145

Decorazione 3D in metallo a taglio laser, spessore 1mm  
Decorative 3d laser-cut metal element, 1mm thick  
200g - h 280mm - l 90mm

MOON



## FINITURE FINISHINGS

	oro gold	EL161
	oro zincato zinc gold	EL162
	rame copper	EL163
	argento zincato zinc silver	EL164
	titanio titanium	EL165

Decorazione 3D in metallo a taglio laser, spessore 1mm  
Decorative 3d laser-cut metal element, 1mm thick  
100g - h 280mm - l 90mm

## ELEMENTS ACQUA



FULL SHELL



### FINITURE FINISHINGS

	oro gold	EL106
	oro zincato zinc gold	EL107
	rame copper	EL108
	argento zincato zinc silver	EL109
	titanio titanium	EL110

Decorazione 3D in metallo a taglio laser, spessore 1mm  
Decorative 3d laser-cut metal element, 1mm thick  
230g - h 170mm - l 175mm

LITE SHELL



### FINITURE FINISHINGS

	oro gold	EL116
	oro zincato zinc gold	EL117
	rame copper	EL118
	argento zincato zinc silver	EL119
	titanio titanium	EL120

Decorazione 3D in metallo a taglio laser, spessore 1mm  
Decorative 3d laser-cut metal element, 1mm thick  
100g - h 170mm - l 175mm

## ELEMENTS FUOCO



LACRIMA L



### FINITURE FINISHINGS

	oro gold	EL170
	oro zincato zinc gold	EL171
	rame copper	EL172
	argento zincato zinc silver	EL173
	titanio titanium	EL174

Decorazione 3D in metallo a taglio laser, spessore 1mm  
Decorative 3d laser-cut metal element, 1mm thick  
80g - h 200mm - l 35mm

LACRIMA S



### FINITURE FINISHINGS

	oro gold	EL175
	oro zincato zinc gold	EL176
	rame copper	EL177
	argento zincato zinc silver	EL178
	titanio titanium	EL179

Decorazione 3D in metallo a taglio laser, spessore 1mm  
Decorative 3d laser-cut metal element, 1mm thick  
50g - h 150mm - l 30mm





# ROSONI E GANCI CEILING ROSES AND HOOKS



**90**  
Rosone rettangolare  
6 uscite e 12 ganci per gli elementi  
fermacavi inclusi  
Rectangular ceiling rose  
6 outputs and 12 hooks  
for the elements  
cable clamps included  
20mm - 90mm



### FINITURE FINISHINGS

	oro gold	EL286
	rame copper	EL288
	titanio titanium	EL287



**60**  
Rosone rettangolare  
4 uscite e 8 ganci per gli elementi  
fermacavi inclusi  
Rectangular ceiling rose  
4 outputs and 8 hooks  
for the elements  
cable clamps included  
12mm - 60mm

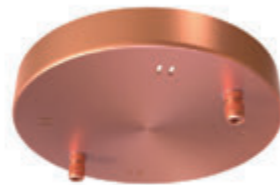

### FINITURE FINISHINGS

	oro gold	EL283
	rame copper	EL285
	titanio titanium	EL284





**ROUND**  
Rosone tondo  
2 uscite e 4 ganci per gli elementi  
fermacavi inclusi  
Round ceiling rose  
2 outputs and 4 hooks  
for the elements  
cable clamps included  
Ø 20mm

### FINITURE FINISHINGS

	oro gold	EL280
	rame copper	EL282
	titanio titanium	EL281

**WAND**  
40cm



### FINITURE FINISHINGS

	oro gold	EL150
	titanio titanium	EL151



**HOOK L**  
11cm



### FINITURE FINISHINGS

	oro gold	EL154
	titanio titanium	EL155



**HOOK S**  
4cm

### FINITURE FINISHINGS

	oro gold	EL152
	titanio titanium	EL153

# PORTALAMPADE LAMP HOLDERS





### SWITCH

Metallo, E27, interruttore rotativo, interno in bachelite, connettore di terra e pressacavo inclusi  
Metal lamp holder, E27, rotary switch, inner bakelite, ground connector and gland included  
Ø 50mm ing. max 65mm h 100mm



**AH142** nero black  
**AH143** corten corten  
**AH141** bianco white



**AH120** titanio titanium  
**AH104** canna di fucile gunmetal  
**AH107** nichel nickel  
**AH008** cromo chrome  
**AH111** argento silver



**AH123** brunito burnished  
**AH127** ottone brass  
**AH115** oro gold  
**AH131** bronzo bronze  
**AH118** rame copper

### VINTAGE

Portalamпада vintage, E27, in metallo, interno in bachelite, connettore di terra e pressacavo inclusi  
Metal vintage lamp holder, E27, inner bakelite with ground connector and gland included  
Ø 50mm h 85mm



**AH145** nero black  
**AH146** corten corten  
**AH144** bianco white



**AH121** titanio titanium  
**AH140** canna di fucile gunmetal  
**AH109** nichel nickel  
**AH101** cromo chrome  
**AH113** argento silver



**AH125** brunito burnished  
**AH129** ottone brass  
**AH117** oro gold  
**AH133** bronzo bronze  
**AH119** rame copper



### MATERIC

Portalamпада zigrinato in metallo E27 interno in bachelite connettore di terra e pressacavo inclusi  
metal knurled lamp holder E27 inner bakelite ground connector and gland included  
Ø 46mm h 100mm



**AH148** nero black  
**AH149** corten corten  
**AH147** bianco white



**AH673** titanio titanium  
**AH665** canna di fucile gunmetal  
**AH667** nichel nickel  
**AH663** cromo chrome  
**AH669** argento silver



**AH675** brunito burnished  
**AH677** ottone brass  
**AH670** oro gold  
**AH679** bronzo bronze  
**AH672** rame copper

### TOBE

Lega di alluminio aeronautica 6020, E27, interno in bachelite, fermacavo metallico  
Aluminum alloy aeronautics 6020, E27, gunmetal color, interior bakelite, metal cable clamp  
Ø 44mm h 120mm



**AH756** nero black  
**AH757** corten corten  
**AH754** bianco white



**AH752** titanio titanium  
**AH753** canna di fucile gunmetal  
**AH755** brunito burnished  
**AH750** ottone brass  
**AH751** bronzo bronze







### BRONX

Metallo, E27, interno ceramica, connettore di terra e accessori inclusi  
Metal E27, inner in ceramic, ground connector and gland included  
Ø 38mm h 55mm



**AH031** canna di fucile gunmetal  
**AH030** ottone brass  
**AH034** cromo chrome  
**AH032** oro gold  
**AH033** rame copper

### GHIERA

Ghiera filettata per BRONX  
Threaded ring nut for BRONX  
Ø 38mm h 55mm



**GH021** canna di fucile gunmetal  
**GH020** ottone brass  
**GH024** cromo chrome  
**GH022** oro gold  
**GH023** rame copper

### BICCHIERINO

Bicchierino in metallo con portalampada E27 in bachelite e accessori inclusi  
Metal cup with E27 lamp holder in bakelite and accessories included  
Ø 42mm h 61mm



**AX934** nero black  
**AX927** bianco white  
**AX925** cromo chrome



### MARMO

Portalampada in marmo, E27, interno in bachelite, connettore di terra  
Marble lamp holder, E27, inner bachelite, ground connector  
Ø 60mm h 125mm



**AH705** titanio titanium  
**AH704** ottone brass  
**AH703** oro gold

**AH702** titanio titanium  
**AH701** ottone brass  
**AH700** oro gold



### PASTELLO

Bicchierino in metallo con portalampada E27 in bachelite e accessori inclusi  
Metal cup with E27 lamp holder in bakelite and accessories included  
Ø 42mm - h 61mm



**AX951** lavanda lavender  
**AX953** senape mustard  
**AX955** kaki kaki  
**AX956** acqua aqua

**AX931** limone lemon  
**AX954** pistacchio pistachio  
**AX949** corallo coral  
**AX950** petrolio petrol



# DECENTRATORI WALL BRACKETS



## DECENTRATORI S

Decentratore in alluminio con regolazione per cavo 3x0,75mm  
Wall brackets in aluminum with regulation for 3x0,75mm cable  
Ø 15mm  
h 15mm

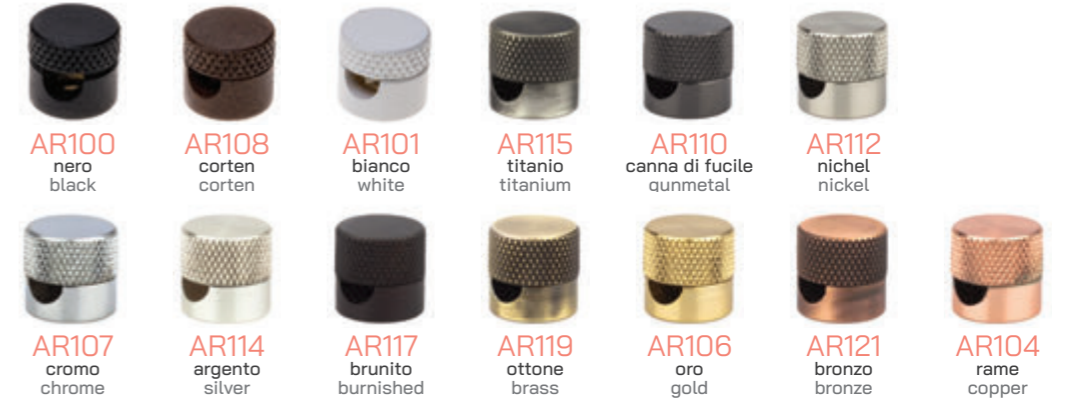

## DECENTRATORI L

Decentratore in alluminio con regolazione per cavo 3x0,75mm  
Wall brackets in aluminum with regulation for 3x0,75mm cable  
Ø 20mm  
h 14mm



## DECENTRATORI 90°

Decentratore verticale in alluminio da soffitto con egolazione per cavo 3x0,75mm  
Vertical aluminium ceiling brackets with regulation for 3x0,75mm cable  
Ø 10mm h 40mm



## DECENTRATORI PASTELLO PASTEL WALL BRACKETS

### DECENTRATORI S

Decentratore in alluminio con regolazione per cavo 3x0,75mm  
Wall brackets in aluminum with regulation for 3x0,75mm cable  
Ø 15mm  
h 15mm



**AR402**  
lavanda  
lavender



**AR404**  
senape  
mustard



**AR405**  
kaki  
kaki



**AR407**  
acqua  
aqua



**AR403**  
limone  
lemon



**AR406**  
pistacchio  
pistachio



**AR400**  
corallo  
coral



**AR401**  
petrolio  
petrol



**AR422**  
lavanda  
lavender



**AR424**  
senape  
mustard



**AR425**  
kaki  
kaki



**AR427**  
acqua  
aqua



**AR423**  
limone  
lemon



**AR426**  
pistacchio  
pistachio



**AR420**  
corallo  
coral



**AR421**  
petrolio  
petrol

### DECENTRATORI 90°

Decentratore verticale in alluminio da soffitto con egolazione per cavo 3x0,75mm  
Vertical aluminium ceiling brackets with regulation for 3x0,75mm cable  
Ø 10mm h 40mm

## FERMACAVI CABLE CLAMPS

### PC100

Fermacavo in metallo galvanizzato filettatura femmina  
M 10x1  
Galvanic metal Cable clamp female thread  
M 10x1  
Ø 13mm - h 21mm



## SNODI JOINTS

### SN100

Snodo in ottone galvanizzato 90° x 360°  
doppia filettatura maschio-femmina  
M 10x1  
Brass joint 90° x 360°  
double thread male-female  
M 10x1  
Ø 13mm - h 38mm



## COPPETTE CUPS

Rosone in metallo kit accessori incluso  
Metal ceiling rose accessories kit included  
Ø 100mm - h 35mm



**AX900**  
metallo cromato  
chrome metal



**AX902**  
bianco  
white



**AX909**  
nero  
black

### FINITURE FINISHINGS

#### GALVANIZZATE GALVANIC

	-OT ottone brass
	-BZ bronzo bronze
	-TI titanio titanium
	-BR brunito burnished
	-CF c. di fucile metalgun

#### GRAFITE GRAPHITE

	-BI bianco white
	-NE nero black
	-CO corten corten

### FINITURE FINISHINGS

#### GALVANIZZATE GALVANIC

	-OT ottone brass
	-BZ bronzo bronze
	-TI titanio titanium
	-BR brunito burnished
	-CF c. di fucile metalgun





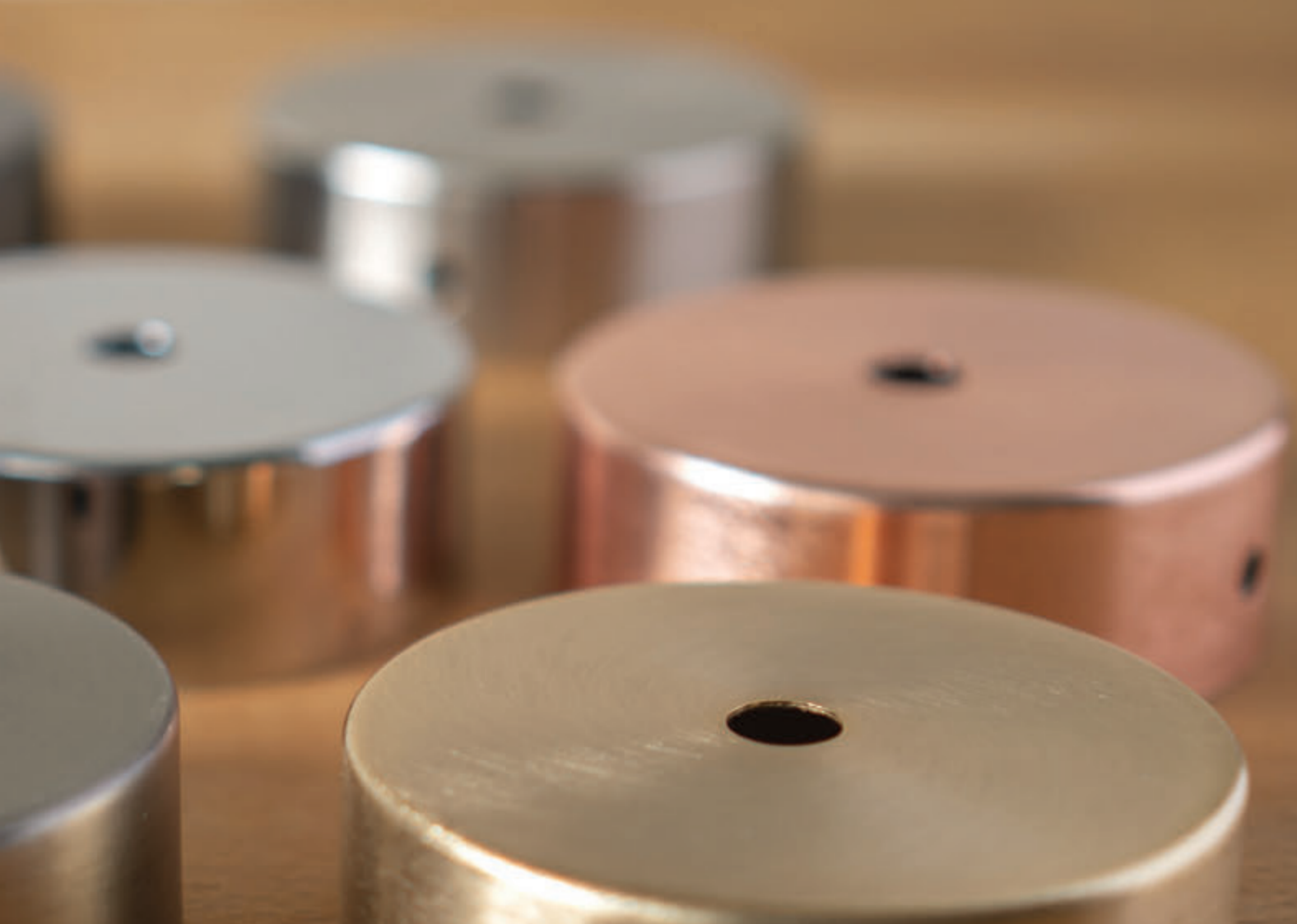







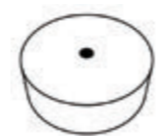

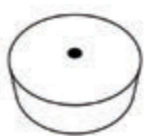

#### GRAFITE GRAPHITE

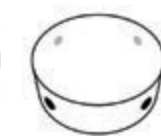
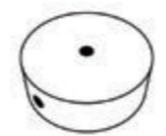
	-BI bianco white
	-NE nero black
	-CO corten corten



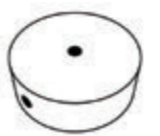









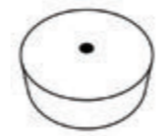



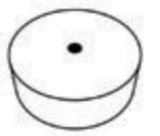

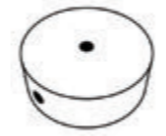

# ROSONI CEILING ROSES

Rosone in metallo con staffa e accessori in dotazione  
Ceiling rose in metal 35mm with bracket and accessories included  
Ø 100mm h 35mm

 <b>AR080</b> 1 foro x7 - 1 hole x7	 <b>AR060</b> 1 foro - 1 hole ø65mm h35mm	 <b>AR170</b> 1 foro - 1 hole ø65mm h35mm					
 <b>AR070</b> 1 foro - 1 hole	 <b>AR030</b> 3 fori - 3 holes	 <b>AR090</b> 7 fori - 7 holes	 <b>AR300</b> 4 uscite - 4 outputs	 <b>AR171</b> 1 foro - 1 hole	 <b>AR172</b> 3 fori - 3 holes	 <b>AR173</b> 7 fori - 7 holes	 <b>AR174</b> 4 uscite - 4 outputs
 <b>AR388</b> 1 foro - 1 hole + 1 uscita + 1 output	 <b>AR220</b> 1 foro - 1 hole + 2 uscite + 2 outputs	 <b>AR240</b> 1 foro - 1 hole + 2 uscite a L + 2 L outputs	 <b>AR260</b> 1 foro - 1 hole + 4 uscite + 4 outputs	 <b>AR178</b> 1 foro - 1 hole + 1 uscita + 1 output	 <b>AR175</b> 1 foro - 1 hole + 2 uscite + 2 outputs	 <b>AR176</b> 1 foro - 1 hole + 2 uscite a L + 2 L outputs	 <b>AR177</b> 1 foro - 1 hole + 4 uscite + 4 outputs

 <b>AR081</b> 1 foro x7 - 1 hole x7	 <b>AR061</b> 1 foro - 1 hole ø65mm h35mm		
 <b>AR071</b> 1 foro - 1 hole	 <b>AR031</b> 3 fori - 3 holes	 <b>AR091</b> 7 fori - 7 holes	 <b>AR301</b> 4 uscite - 4 outputs
 <b>AR389</b> 1 foro - 1 hole + 1 uscita + 1 output	 <b>AR221</b> 1 foro - 1 hole + 2 uscite + 2 outputs	 <b>AR241</b> 1 foro - 1 hole + 2 uscite a L + 2 L outputs	 <b>AR261</b> 1 foro - 1 hole + 4 uscite + 4 outputs

 <b>AR016</b> 1 foro - 1 hole ø65mm h35mm	 <b>AR087</b> 1 foro - 1 hole ø65mm h35mm						
 <b>AR038</b> 1 foro - 1 hole	 <b>AR059</b> 3 fori - 3 holes	 <b>AR155</b> 7 fori - 7 holes	 <b>AR314</b> 4 uscite - 4 outputs	 <b>AR023</b> 1 foro - 1 hole	 <b>AR049</b> 3 fori - 3 holes	 <b>AR148</b> 7 fori - 7 holes	 <b>AR307</b> 4 uscite - 4 outputs
 <b>AR376</b> 1 foro - 1 hole + 1 uscita + 1 output	 <b>AR335</b> 1 foro - 1 hole + 2 uscite + 2 outputs	 <b>AR356</b> 1 foro - 1 hole + 2 uscite a L + 2 L outputs	 <b>AR377</b> 1 foro - 1 hole + 4 uscite + 4 outputs	 <b>AR313</b> 1 foro - 1 hole + 1 uscita + 1 output	 <b>AR328</b> 1 foro - 1 hole + 2 uscite + 2 outputs	 <b>AR349</b> 1 foro - 1 hole + 2 uscite a L + 2 L outputs	 <b>AR370</b> 1 foro - 1 hole + 4 uscite + 4 outputs



AR082  
1 foro x7 - 1 hole x7



AR089  
1 foro - 1 hole  
Ø65mm h35mm



AR018  
1 foro - 1 hole  
Ø65mm h35mm



AR086  
1 foro x7 - 1 hole x7



AR068  
1 foro - 1 hole  
Ø65mm h35mm

titanio - titanium  
Ø100mm h 35mm

AR099  
1 foro - 1 hole  
Ø65mm h35mm

nickel - nickel  
Ø100mm h 35mm

AR089  
1 foro - 1 hole  
Ø65mm h35mm

ottone - brass  
Ø100mm h 35mm

AR018  
1 foro - 1 hole  
Ø65mm h35mm

oro - gold  
Ø100mm h 35mm

AR068  
1 foro - 1 hole  
Ø65mm h35mm

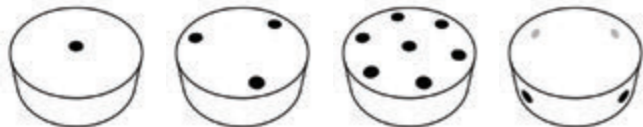

AR028 1 foro - 1 hole  
AR057 3 fori - 3 holes  
AR153 7 fori - 7 holes  
AR312 4 uscite - 4 outputs

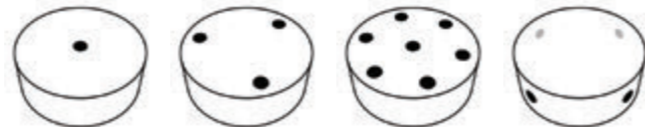

AR025 1 foro - 1 hole  
AR054 3 fori - 3 holes  
AR150 7 fori - 7 holes  
AR309 4 uscite - 4 outputs

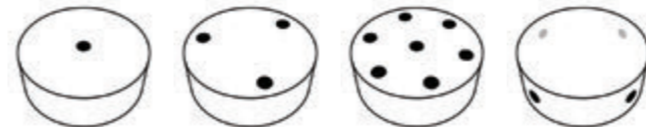

AR040 1 foro - 1 hole  
AR141 3 fori - 3 holes  
AR157 7 fori - 7 holes  
AR316 4 uscite - 4 outputs



AR079 1 foro - 1 hole  
AR047 3 fori - 3 holes  
AR146 7 fori - 7 holes  
AR306 4 uscite - 4 outputs

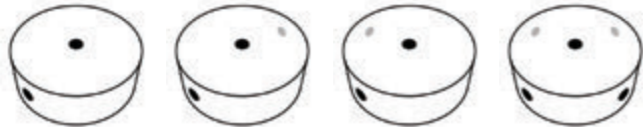

AR391 1 foro - 1 hole + 1 uscita + 1 output  
AR333 1 foro - 1 hole + 2 uscite + 2 outputs  
AR354 1 foro - 1 hole + 2 uscite a L + 2 L outputs  
AR375 1 foro - 1 hole + 4 uscite + 4 outputs

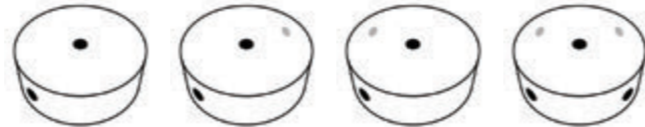

AR161 1 foro - 1 hole + 1 uscita + 1 output  
AR330 1 foro - 1 hole + 2 uscite + 2 outputs  
AR351 1 foro - 1 hole + 2 uscite a L + 2 L outputs  
AR372 1 foro - 1 hole + 4 uscite + 4 outputs

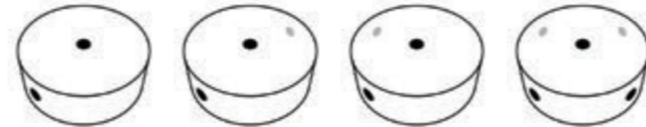

AR334 1 foro - 1 hole + 1 uscita + 1 output  
AR337 1 foro - 1 hole + 2 uscite + 2 outputs  
AR358 1 foro - 1 hole + 2 uscite a L + 2 L outputs  
AR379 1 foro - 1 hole + 4 uscite + 4 outputs



AR321 1 foro - 1 hole + 1 uscita + 1 output  
AR327 1 foro - 1 hole + 2 uscite + 2 outputs  
AR348 1 foro - 1 hole + 2 uscite a L + 2 L outputs  
AR369 1 foro - 1 hole + 4 uscite + 4 outputs



AR098  
1 foro - 1 hole  
Ø65mm h35mm



AR021  
1 foro - 1 hole  
Ø65mm h35mm



AR020  
1 foro - 1 hole  
Ø65mm h35mm



AR085  
1 foro x7 - 1 hole x7



AR067  
1 foro - 1 hole  
Ø65mm h35mm

argento - silver  
Ø100mm h 35mm

AR098  
1 foro - 1 hole  
Ø65mm h35mm

cromo - chrome  
Ø100mm h 35mm

AR021  
1 foro - 1 hole  
Ø65mm h35mm

bronzo - bronze  
Ø100mm h 35mm

AR020  
1 foro - 1 hole  
Ø65mm h35mm

rame - copper  
Ø100mm h 35mm

AR067  
1 foro - 1 hole  
Ø65mm h35mm



AR027 1 foro - 1 hole  
AR056 3 fori - 3 holes  
AR152 7 fori - 7 holes  
AR311 4 uscite - 4 outputs



AR043 1 foro - 1 hole  
AR032 3 fori - 3 holes  
AR092 7 fori - 7 holes  
AR319 4 uscite - 4 outputs

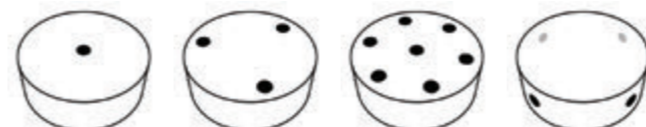

AR042 1 foro - 1 hole  
AR143 3 fori - 3 holes  
AR159 7 fori - 7 holes  
AR318 4 uscite - 4 outputs



AR078 1 foro - 1 hole  
AR046 3 fori - 3 holes  
AR145 7 fori - 7 holes  
AR305 4 uscite - 4 outputs

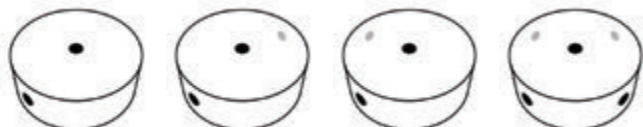

AR387 1 foro - 1 hole + 1 uscita + 1 output  
AR332 1 foro - 1 hole + 2 uscite + 2 outputs  
AR353 1 foro - 1 hole + 2 uscite a L + 2 L outputs  
AR374 1 foro - 1 hole + 4 uscite + 4 outputs

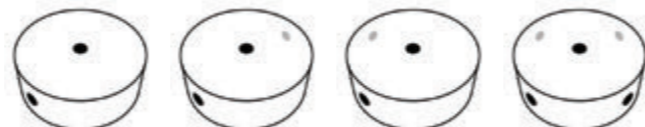

AR385 1 foro - 1 hole + 1 uscita + 1 output  
AR340 1 foro - 1 hole + 2 uscite + 2 outputs  
AR361 1 foro - 1 hole + 2 uscite a L + 2 L outputs  
AR382 1 foro - 1 hole + 4 uscite + 4 outputs

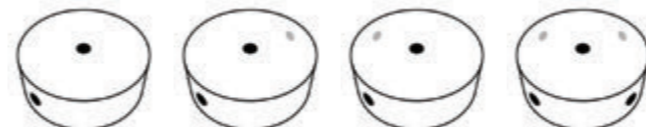

AR363 1 foro - 1 hole + 1 uscita + 1 output  
AR339 1 foro - 1 hole + 2 uscite + 2 outputs  
AR360 1 foro - 1 hole + 2 uscite a L + 2 L outputs  
AR381 1 foro - 1 hole + 4 uscite + 4 outputs



AR342 1 foro - 1 hole + 1 uscita + 1 output  
AR326 1 foro - 1 hole + 2 uscite + 2 outputs  
AR347 1 foro - 1 hole + 2 uscite a L + 2 L outputs  
AR368 1 foro - 1 hole + 4 uscite + 4 outputs

ROSONCINI PASTELLO  
PASTEL CEILING ROSES



AR951

lavanda - lavender  
Ø 77mm - h 26mm



AR953

senape - mustard  
Ø 77mm - h 26mm



AR954

kaki - kaki  
Ø 77mm - h 26mm



AR956

acqua - aqua  
Ø 77mm - h 26mm



AR906

limone - lemon  
Ø 77mm - h 26mm



AR955

pistacchio - pistachio  
Ø 77mm - h 26mm



AR949

corallo - coral  
Ø 77mm - h 26mm

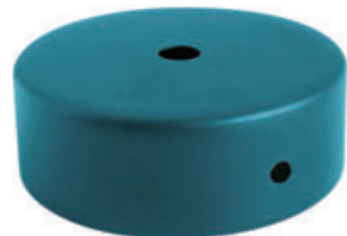

AR950

petrolio - petrol  
Ø 77mm - h 26mm



CAVI  
CABLES





CAVI  
SETA  
SILK CABLES





CAVI  
LARGA SEZIONE  
LARGE SECTION CABLES





CAVI  
COLORI PASTELLO  
PASTEL COLORS CABLES

ARGENTO SILVER	AVORIO IVORY	ORO GOLD	BIANCO WHITE
			
AX266 3x1,5	AX267 3x1,5	AX270 3x1,5	AX254 3x1,5

LAVANDA LAVENDER	SENAPE MUSTARD	KAKI KAKI	ACQUA AQUA
			
AX502 2x0,75	AX602 3x0,75	AX301 2x0,75	AX401 3x0,75
		AX534 2x0,75	AX634 3x0,75
			AX588 2x0,75
			AX688 3x0,75

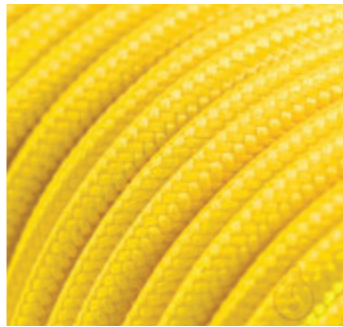
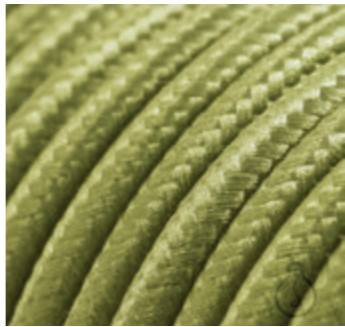
MARRONE BROWN	NERO BLACK	WHISKY
		
AX262 3x1,5	AX263 3x1,5	AX265 3x1,5

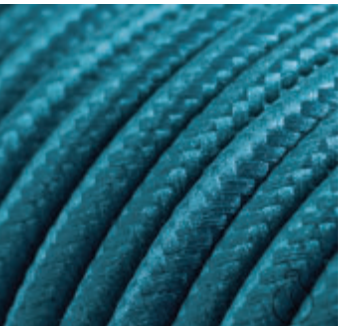
LIMONE LEMON	PISTACCHIO PISTACHIO	CORALLO CORAL	PETROLIO PETROL
			
AX506 2x0,75	AX606 3x0,75	AX590 3x0,75	AX690 3x0,75
	AX590 2x0,75	AX591 2x0,75	AX691 3x0,75
			AX538 2x0,75
			AX638 3x0,75





CAVI  
LINO  
LINEN CABLES

MARRONE BROWN



AX549 2x0,75      AX649 3x0,75

SALVIA SAGE



AX325 2x0,75

BEIGE



AX425 3x0,75      AX539 2x0,75

LABRADOR



AX639 3x0,75      AX679 2x0,75

GRIGIO SCURO DARK GREY



AX683 3x0,75      AX540 2x0,75      AX640 3x0,75

SALVIA SAGE



AX365 2x0,75

BEIGE



AX465 3x0,75      AX716 2x0,75

LABRADOR



AX766 3x0,75      AX379 2x0,75

GRIGIO CHIARO LIGHT GREY



AX383 3x0,75      AX548 2x0,75      AX648 3x0,75



CAVI  
CANAPA  
HEMP CABLES

FUMO SMOKE



AX676 2x0,75

ORIGANO ORIGAN



AX680 3x0,75      AX677 2x0,75

TUFO TUFF



AX681 3x0,75      AX678 2x0,75

TUFO TUFF



AX682 3x0,75      AX686 2x0,75      AX687 3x0,75



CAVI  
JUTA  
JUTE CABLES



CAVI  
COTONE  
COTTON CABLES



NERO BLACK: AX671 2x0,75  
GREZZO RAW: AX675 3x0,75, AX566 2x0,75  
MATTONE BRICK: AX666 3x0,75, AX670 2x0,75  
MILITARE KHAKI: AX674 3x0,75, AX669 2x0,75, AX673 3x0,75



NERO BLACK: AX315 2x0,75  
MARRONE BROWN: AX415 3x0,75, AX317 2x0,75  
TORTORA TAUPE: AX417 3x0,75, AX323 2x0,75  
BIANCO WHITE: AX423 3x0,75, AX314 2x0,75, AX414 3x0,75



NERO BLACK: AX684 2x0,75  
GREZZO RAW: AX685 3x0,75, AX374 2x0,75  
FIENO HAY: AX474 3x0,75, AX489 3x0,75  
MARRONE BROWN: AX667 2x0,75, AX672 3x0,75





NERO BLACK: AX360 2x0,75  
MARRONE BROWN: AX460 3x0,75, AX361 2x0,75  
TORTORA TAUPE: AX461 3x0,75, AX363 2x0,75  
BIANCO WHITE: AX463 3x0,75, AX359 2x0,75, AX459 3x0,75

# PARALUMI LAMP SHADES



**FIORE**  
gabbia in metallo doppia estetica  
metal cage flower model  
double aesthetics  
solo per portalampada  
vintage e switch  
only for vintage and switch  
lamp holder  
Ø 90mm - h 160mm



**FINITURE FINISHINGS**

-  **AG308**  
bianco white
-  **AG300**  
nero black
-  **AG333**  
corten corten



**CANARINO**  
gabbia in metallo  
metal cage canary model  
solo per portalampada  
vintage e switch  
only for vintage and switch  
lamp holder  
Ø 100mm - h 50mm



**FINITURE FINISHINGS**

-  **AG309**  
bianco white
-  **AG301**  
nero black
-  **AG334**  
corten corten



**CHAIN BASE**  
telaio in metallo  
foro portalampada da 43mm  
metal frame  
43mm lamp holder hole  
Ø 450mm - h 320mm



**FINITURE FINISHINGS**

-  **AG349**  
bianco white
-  **AG341**  
nero black
-  **AG389**  
corten corten



**DIAMANTE**  
gabbia in metallo  
metal cage diamond model  
solo per portalampada  
vintage e switch  
only for vintage and switch  
lamp holder  
Ø max 200mm  
Ø base 140mm - h 230mm

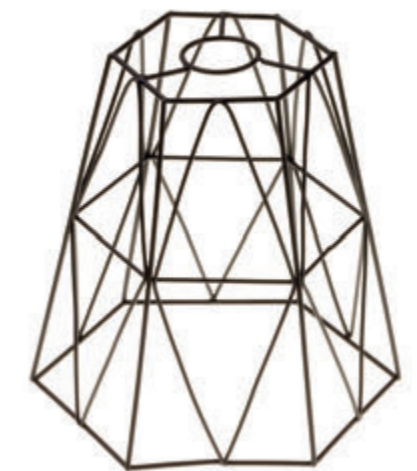

**FINITURE FINISHINGS**

-  **AG310**  
bianco white
-  **AG302**  
nero black
-  **AG335**  
corten corten



**ESAGONO**  
gabbia in metallo  
metal cage hexagonal model  
solo per portalampada  
vintage e switch  
only for vintage and switch  
lamp holder  
Ø base 200mm - h 250mm



**FINITURE FINISHINGS**

-  **AG311**  
bianco white
-  **AG303**  
nero black
-  **AG336**  
corten corten



**OTTAGONO**  
gabbia in metallo  
metal cage octagon model  
solo per portalampada  
vintage e switch  
only for vintage and switch  
lamp holder  
Ø max 200mm  
Ø base 115mm - h 250mm

**FINITURE FINISHINGS**

-  **AG312**  
bianco white
-  **AG304**  
nero black
-  **AG337**  
corten corten



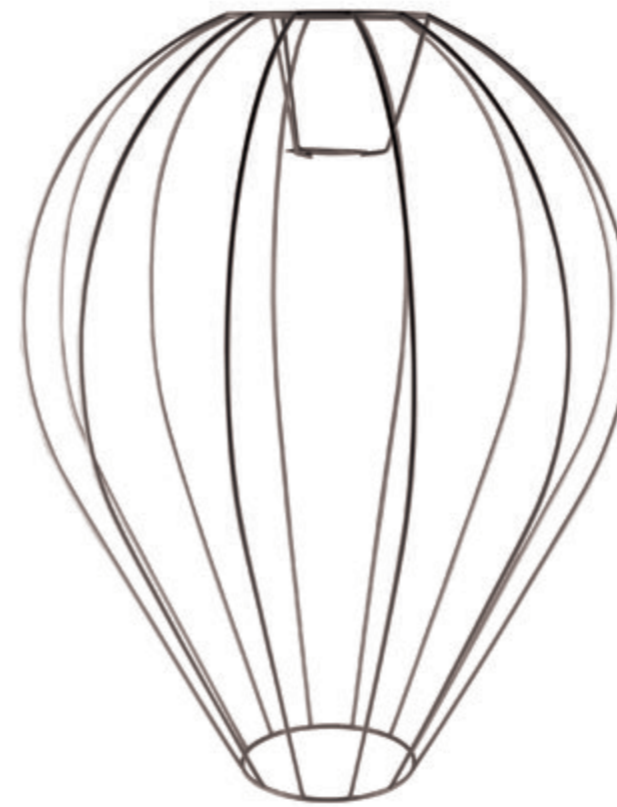

PARALUMI  
GABBIE  
CAGE  
LAMPSHADES



#### MONGOLFIERA

telaio in metallo - foro portalampada da 43mm  
metal frame hot air balloon model - 43mm lamp holder hole  
Ø 480mm - Ø base 135mm - h 580mm

##### FINITURE FINISHINGS



-  **AG347**  
bianco white
-  **AG339**  
nero black
-  **AG387**  
corten corten



#### BALLOON

telaio in metallo - foro portalampada da 43mm  
metal frame - 43mm lamp holder hole  
Ø 300mm - Ø base 90mm - h 370mm

##### FINITURE FINISHINGS



-  **AG364**  
bianco white
-  **AG340**  
nero black
-  **AG388**  
corten corten



#### OLIVETTA

telaio in metallo - foro portalampada da 43mm  
metal frame olive model - 43mm lamp holder hole  
Ø 250mm - Ø base 90mm - h 250mm

##### FINITURE FINISHINGS



-  **AG359**  
bianco white
-  **AG343**  
nero black
-  **AG391**  
corten corten



#### GALAXY

telaio in metallo - foro portalampada da 43mm  
metal frame galaxy model - 43mm lamp holder hole  
Ø 320mm Ø base 190mm - h 290mm

##### FINITURE FINISHINGS

-  **AG346**  
bianco white
-  **AG338**  
nero black
-  **AG386**  
corten corten



PARALUMI  
CAMPANE  
BELLS  
LAMPSHADES



CA503  
bianco  
white



CA504  
nero  
black



CA505  
corten  
corten

DISCO

disco industrial in metallo  
verniciato in grafite su entrambi i lati  
foro per portalamпада Ø 43mm  
metal industrial disk  
varnished on both sides  
hole for lamp holder Ø 43mm  
Ø 400mm  
h 5mm



CA355  
bianco  
white



CA356  
nero  
black



CA357  
corten  
corten

CAMPANA M

campana industrial  
metallo smaltato  
interno bianco  
foro per portalamпада Ø 43mm  
industrial bell  
varnished metal  
white interior  
hole for lamp holder Ø 43mm  
Ø 310mm  
h 150mm



CA360  
bianco  
white



CA361  
nero  
black



CA362  
corten  
corten

CAMPANA L

campana industrial  
metallo smaltato  
interno bianco  
foro per portalamпада Ø 43mm  
industrial bell  
varnished metal  
white interior  
hole for lamp holder Ø 43mm  
Ø 380mm  
h 150mm



Voi comunicateci il codice RAL,  
al resto pensiamo noi

You tell us the ral, we'll take  
care of the rest

"Con i secchi di vernice  
coloriamo tutti i muri,  
case, vicoli e palazzi,  
perché lei ama i colori"

Quantità minime e preventivi da concordare con l'azienda.  
Disponibile per Gabbie e Campane.  
Minimum quantities and quotes to be agreed with the company.  
Available for Cages and Bells.

PORCELLANA  
PORCELAIN



**AC415**  
interruttore deviatore in porcellana  
bianco, kit accessori incluso  
white porcelain button switchman,  
accessory kit included



**AC430**  
presa bipasso in porcellana  
bianca, kit accessori incluso  
white porcelain double-pass  
socket, accessories kit included



**AC433**  
presa schuko in porcellana bianca,  
kit accessori incluso  
white porcelain schuko socket,  
accessories kit included



**AC995**  
portalampada E27 in porcellana  
bianco, kit accessori incluso  
E27 lamp holder in white porcelain,  
accessories kit included



**AC500**  
applique E27 in porcellana base  
dritta bianca ø 75mm h 65mm, kit  
accessori incluso  
E27 applique porcelain white  
straight base ø 75mm h 65mm,  
accessories kit included



**AC501**  
applique E27 in porcellana base  
dritta nera ø 75mm h 65mm, kit  
accessori incluso  
E27 applique porcelain black  
straight base ø 75mm h 65mm,  
accessories kit included



**AC510**  
applique E27 in porcellana base  
inclinata bianca ø 75mm h 65mm,  
kit accessori incluso  
E27 applique porcelain white  
inclined base ø 75mm h 65mm,  
accessories kit included



**AC511**  
applique E27 in porcellana base  
inclinata nera ø 75mm h 65mm, kit  
accessori incluso  
E27 applique porcelain black  
inclined base ø 75mm h 65mm,  
accessories kit included



**AC402**  
isolatore in porcellana bianco  
white porcelain isolator



**AC403**  
isolatore in porcellana corten  
white porcelain corten



**AC448**  
scatola di derivazione in porcellana  
bianca, kit accessori incluso  
white porcelain junction box,  
accessories kit included



**AC923**  
rosone in porcellana bianco, kit  
accessori incluso  
white porcelain ceiling rose,  
accessories kit included



**AT600**  
sospensione tazza 2m, tazza da cappuccino  
in porcellana bianca ø 145mm h 80mm con  
portalampada E27, rosone bianco ø 100mm h 35mm,  
cavo tondo 2x0,75 nero  
2m lamp holder, cappuccino cup in white ceramic  
ø 145mm h 80mm with E27 lamp holder, white ceiling  
rose ø 100mm h 35mm, 2x0,75 black round cable



**AT700**  
sospensione tazzina 2m, tazzina da caffè  
in porcellana bianca ø 115mm h 70mm con  
portalampada E27, rosone bianco ø 100mm h 35mm,  
cavo tondo 2x0,75 rosso  
2m lamp holder, coffee cup in white ceramic  
ø 115mm h 70mm with E27 lamp holder, white ceiling  
rose ø 100mm h 35mm, 2x0,75 red round cable

# GHIRLANDE GUIRLANDES

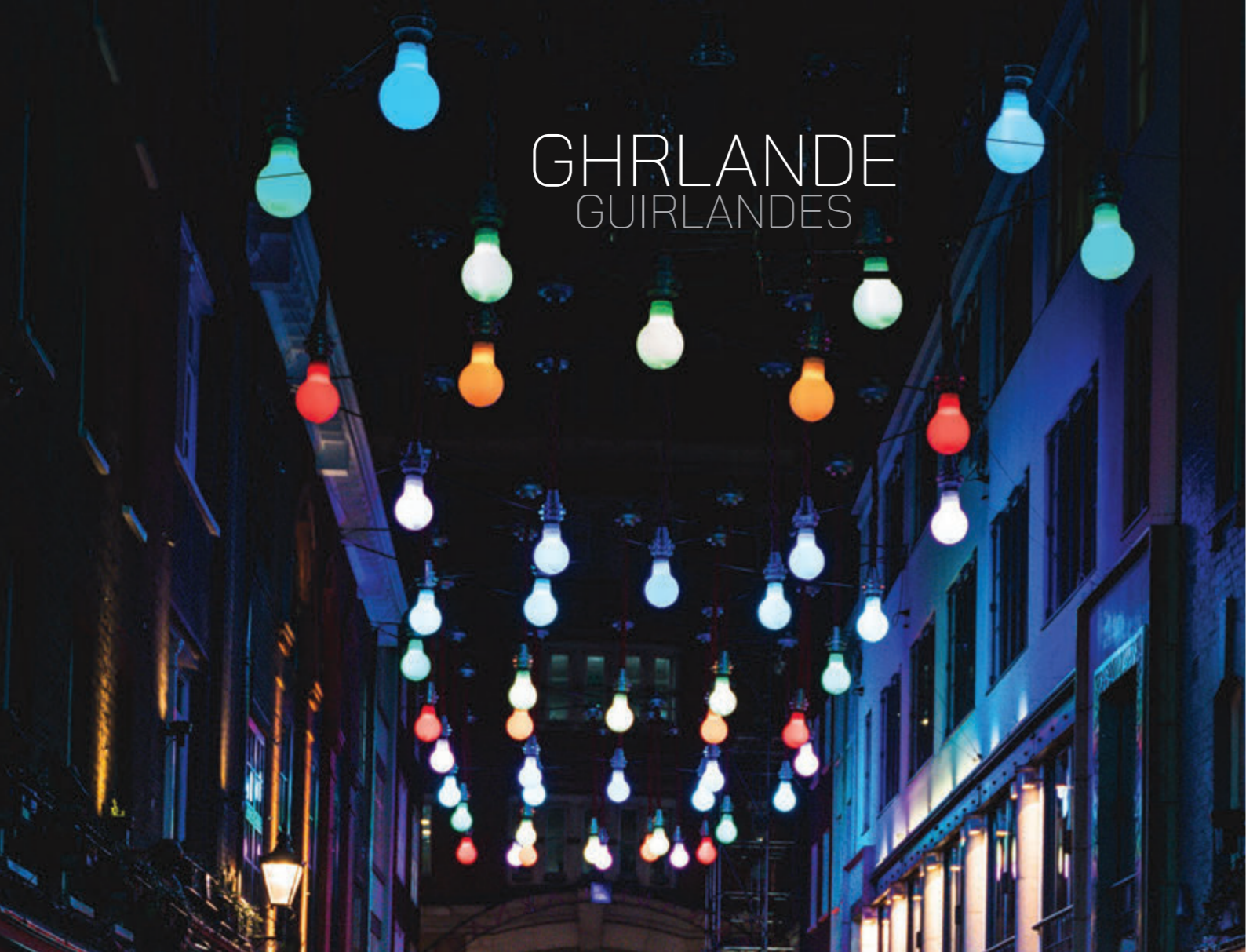

**BT700**  
nero - black



**BT701**  
bianco - white



**BT708**  
corten - corten

**CAVO CABLE**  
per costruzione ghirlande  
for guirlandes construction  
2x1,5mm  
max 1500W  
IP44 da esterno  
IP44 outdoor  
vendita al metro, minimo 10m  
sale by the meter, minimum 10m



**BT900**  
nero - black



**BT901**  
bianco - white



**BT908**  
corten - corten

**PORTALAMPADE  
LAMP HOLDERS**  
E27  
per costruzione ghirlande  
for guirlandes construction  
IP44 da esterno  
IP44 outdoor  
kit accessori incluso  
accessories kit included



**BT905**  
nero - black

**BT905  
SCHUKO**  
spina nera schuko  
black schuko plug  
per costruzione ghirlande  
for guirlandes construction  
per cavo piatto  
for flat cable  
IP44 da esterno  
IP44 outdoor



**BT906**  
bianco - white

**BT906  
TERMINAZIONE  
TERMINATION**  
terminazione nera con uncino in metallo  
Black termination with metal hook per  
costruzione ghirlande  
for guirlandes construction  
per cavo piatto  
for flat cable  
IP44 da esterno  
IP44 outdoor



**NERO BLACK**  
E27 - 220Vac - max 1500W  
IP44 da esterno  
IP44 outdoor  
cavo tondo 2\*1,0mm in rame  
2\*1.0mm round copper cable  
spina schuko  
schuko plug

**BT500**  
11 portalampe 11 lamp holders  
12m  
**BT513**  
10 portalampe 10 lamp holders  
5m + 5m  
**BT510**  
5 portalampe 5 lamp holders  
estensione extension 5m



**BIANCO WHITE**  
E27 - 220Vac - max 1500W  
IP44 da esterno  
IP44 outdoor  
cavo tondo 2\*1,0mm in rame  
2\*1.0mm round copper cable  
spina schuko  
schuko plug

**BT501**  
11 portalampe 11 lamp holders  
12m  
**BT511**  
10 portalampe 10 lamp holders  
5m + 5m  
**BT512**  
5 portalampe 5 lamp holders  
estensione extension 5m



**BT502  
VERDE MENTA GREEN MINT**  
E27  
220Vac  
max 1500W  
IP44 da esterno  
IP44 outdoor  
11 portalampe  
11 lamp holders  
cavo tondo 2\*1,0mm in rame  
2\*1.0mm round copper cable  
spina schuko  
schuko plug  
12m



**BT503  
ROSA PINK**  
E27  
220Vac  
max 1500W  
IP44 da esterno  
IP44 outdoor  
11 portalampe  
11 lamp holders  
cavo tondo 2\*1,0mm in rame  
2\*1.0mm round copper cable  
spina schuko  
schuko plug  
12m

# FUNI CORDS



## ROSONI CEILING ROSES

rosone in legno  
kit accessori incluso  
wood ceiling rose  
accessories kit included  
Ø 120mm - h 30mm



**AR900**  
foro - hole: Ø 10mm



**AR901**  
foro - hole: Ø 16mm



**AR902**  
foro - hole: Ø 24mm



**AR903**  
foro - hole: Ø 30mm

CAVI CORDS  
rivestimento in juta grezza  
covered in raw jute  
3x0,75mm



**FX900**  
Ø 10mm



**FX901**  
Ø 16mm

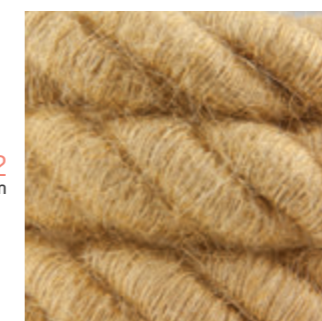

**FX902**  
Ø 24mm

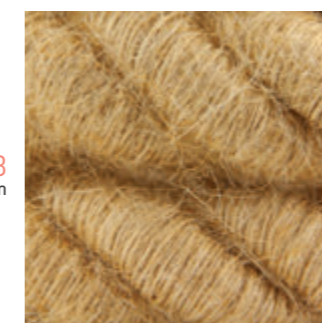

**FX903**  
Ø 30mm

PORTALAMPADE  
LAMP HOLDERS  
in legno naturale - E27 - per fune nautica  
interno in bachelite incluso  
in natural wood - E27 for nautical rope  
inner in - bakelite  
Ø 50mm - h 110mm



**AH900**  
foro - hole: Ø 10mm



**AH901**  
foro - hole: Ø 16mm



**AH902**  
foro - hole: Ø 24mm



**AH903**  
foro - hole: Ø 30mm



# ACCESSORI ACCESSORIES

# LAMPADINE DI RICAMBIO SPARE BULBS



**10100**  
presa in policarbonato  
anti fiamma  
flameproof  
polycarbonate socket



**10000**  
spina 10A 4mm in  
policarbonato  
polycarbonate 10A 4mm  
plug



**10030**  
spina 16A 5mm in  
policarbonato  
polycarbonate 16A 5mm  
plug



**10040**  
adattatore spina 10A  
presa  
10A plug adapter socket



**10050**  
adattatore spina 16A  
presa  
16A plug adapter socket



**10060**  
adattatore spina 16A-3  
prese  
plug adapter 16A-3  
sockets



**10070**  
adattatore spina 16A-2  
prese  
plug adapter 16A-2  
sockets



**10401**  
multipresa 3 posizioni  
cavo 3  
power strip 3 cable  
positions 3



**10310**  
interruttore passafilo  
bianco  
white wire switch



**10409**  
multipresa con  
interruttore  
power strip with switch



**10500**  
prolunga lineare spina e  
presa 10A  
linear extension plug and  
socket 10A



**10530**  
prolunga lineare spina e  
presa 16A  
linear extension plug and  
socket 16A



**AX938**  
portalampada in bachelite  
E27 nero  
bakelite lamp holder E27  
black



**AX937**  
portalampada in bachelite  
E27 bianco  
bakelite lamp holder E27  
white



**AX936**  
portalampada in bachelite  
E14 nero  
bakelite lamp holder E14  
black



**AR012**  
fermacavo trasparente,  
confezione da 10pz  
transparent cable clamp,  
pack of 10pcs



**AR013**  
fermacavo bianco,  
confezione da 10pz  
white cable clamp,  
pack of 10pcs



**AR014**  
fermacavo nero,  
confezione da 10pz  
black cable clamp,  
pack of 10pcs



**AR010**  
gancio trasparente  
per fissaggio cavi a sof-  
fitto confezione da 10pz  
transparent hook  
for fixing cables to ceiling  
pack of 10pcs



**AK013**  
piastrina tendicavo  
trasparente, confezione  
10pz  
transparent tension plate,  
pack 10pcs



## DIMMABLES POWER GU10 DIMMERABILI

**LB939** -GPN  
POWER GU10  
3000K  
12W - 940lm - 220V  
fascio di luce 60°  
light beam 60°  
vetro chiaro  
clear glass  
dimmerabile  
dimmable  
CRI >90Ra

**LB940** -GPC  
POWER GU10  
2700K  
12W - 935lm - 220V  
fascio di luce 60°  
light beam 60°  
vetro chiaro  
clear glass  
dimmerabile  
dimmable  
CRI >90Ra

**LB941** -GPF  
POWER GU10  
4000K  
12W - 950lm - 220V  
fascio di luce 60°  
light beam 60°  
vetro chiaro  
clear glass  
dimmerabile  
dimmable  
CRI >90Ra



## DIMMABLES GU10 DIMMERABILI

**LB943** -GDH  
GU10  
2700K  
8W - 660lm - 220V  
fascio di luce 60°  
light beam 60°  
vetro chiaro  
clear glass  
dimmerabile  
dimmable  
CRI >90Ra

**LB931** -GDW  
GU10  
3000K  
8W - 700lm - 220V  
fascio di luce 60°  
light beam 60°  
vetro chiaro  
clear glass  
dimmerabile  
dimmable  
CRI >90Ra

**LB930** -GDD  
GU10  
4000K  
8W - 750lm - 220V  
fascio di luce 60°  
light beam 60°  
vetro chiaro  
clear glass  
dimmerabile  
dimmable  
CRI >90Ra

**LB937** -GDN  
GU10  
3000K  
7W - 420lm - 220V  
fascio di luce 15°  
light beam 5°  
vetro chiaro  
clear glass  
dimmerabile  
dimmable  
CRI >90Ra



## NOT DIMMABLES GU10 NON DIMMERABILI

**LB936** -GLC  
GU10  
2700K  
6W - 570lm - 220V  
fascio di luce 60°  
light beam 60°  
vetro chiaro  
clear glass  
non dimmerabile  
not dimmable  
CRI >90Ra

**LB935** -GLN  
GU10  
3000K  
6W - 594lm - 220V  
fascio di luce 60°  
light beam 60°  
vetro chiaro  
clear glass  
non dimmerabile  
not dimmable  
CRI >90Ra

**LB934** -GLF  
GU10  
4000K  
6W - 616lm - 220V  
fascio di luce 60°  
light beam 60°  
vetro chiaro  
clear glass  
non dimmerabile  
not dimmable  
CRI >90Ra

**LB933** -GOW  
GU10  
2700K  
7,5W - 640lm - 220V  
fascio di luce 120°  
light beam 120°  
vetro opale  
opal glass  
non dimmerabile  
not dimmable  
CRI >90Ra

**LB932** -GOD  
GU10  
4000K  
7,5W - 640lm - 220V  
fascio di luce 120°  
light beam 120°  
vetro opale  
opal glass  
non dimmerabile  
not dimmable  
CRI >90Ra



## NOT DIMMABLES MINI GU10 NON DIMMERABILI

**LB117** -MLC  
MINI GU10  
2700K  
4W - 285lm - 220V  
fascio di luce 60°  
light beam 60°  
vetro chiaro  
clear glass  
non dimmerabile  
not dimmable  
CRI >90Ra

**LB115** -MLN  
MINI GU10  
4000K  
4W - 300lm - 220V  
fascio di luce 60°  
light beam 60°  
vetro chiaro  
clear glass  
non dimmerabile  
not dimmable  
CRI >90Ra

**LB116** -MLF  
MINI GU10  
4000K  
4W - 315lm - 220V  
fascio di luce 60°  
light beam 60°  
vetro chiaro  
clear glass  
non dimmerabile  
not dimmable  
CRI >90Ra



## DIMMABLES MINI GU10 DIMMERABILI

**LB938** -MDW  
MINI GU10  
3000K  
4W - 300lm - 220V  
fascio di luce 38°  
light beam 38°  
vetro chiaro  
clear glass  
dimmerabile  
dimmable  
CRI >90Ra



## DIMMABLES POWER AR111 DIMMERABILI

**LB944** -ALN  
AR111  
3000K  
13W - 900lm - 220V  
fascio di luce 45°  
light beam 45°  
vetro cromo  
chrome glass  
dimmerabile  
dimmable  
CRI >90Ra

**LB945** LB945  
AR111  
2700K  
13W - 880lm - 220V  
fascio di luce 45°  
light beam 45°  
vetro cromo  
chrome glass  
dimmerabile  
dimmable  
CRI >90Ra

**LB946** -ALF  
AR111  
4000K  
13W - 950lm - 220V  
fascio di luce 45°  
light beam 45°  
vetro cromo  
chrome glass  
dimmerabile  
dimmable  
CRI >90Ra



## NOT DIMMABLES GX53 NON DIMMERABILI

**LB950** -XLN  
GX53  
3000K  
6,5W - 700lm - 220V  
fascio di luce 110°  
light beam 110°  
vetro opale  
opal glass  
non dimmerabile  
not dimmable  
CRI >90Ra

**LB951** -XLF  
GX53  
4000K  
6,5W - 700lm - 220V  
fascio di luce 110°  
light beam 110°  
vetro opale  
opal glass  
non dimmerabile  
not dimmable  
CRI >90Ra



## NOT DIMMABLES G9 230VAC NON DIMMERABILI

**LB952** -9LN  
G9  
3000K  
4W - 400lm - 220V  
fascio di luce 360°  
light beam 360°  
vetro chiaro  
clear glass  
non dimmerabile  
not dimmable  
CRI >90Ra

**LB953** -9LF  
G9  
4000K  
4W - 400lm - 220V  
fascio di luce 360°  
light beam 360°  
vetro chiaro  
clear glass  
non dimmerabile  
not dimmable  
CRI >90Ra

# PRODUZIONE MANUFACTURING



## La cura nei dettagli

Alluminio Anti Corodal 6061 con trattamento in bagno galvanico in materiali puri come Oro, Argento, Berilio, Manganese, Platino, Rame, Ottone Navale. Spazzolatura e finitura manuale con elettrolucidatura trasparente. Assemblaggio manuale per ogni singolo prodotto. Questo è quello che facciamo con i nostri accessori per illuminare gli ambienti.

## Non ci accontentiamo di un semplice portalampada, dobbiamo farlo bene

I portalampade Edison E27 sono disegnati e studiati dai nostri tecnici e designer. Sono composti da diverse parti, tutte assemblate con cura e trattate galvanicamente in ogni singola vite, ghiera o corpo. Internamente la Bakelite garantisce le massime prestazioni elettriche. Abbiamo inoltre inserito una boccola di messa a terra per garantire la possibilità di connessione in Classe 1.

## Non ci accontentiamo del cavo ricoperto, vogliamo curare tessuti e materiali

Utilizziamo solo cavo a Norma CPR ed EN 50525-2-11, made in Italy. In Italia cerchiamo e troviamo i filati migliori, le migliori sete, ...canape e cotone, rivestendo il nostro cavo elettrico con la massima cura nei dettagli e nel rispetto delle normative.

## Noi lo facciamo meglio

Li testiamo uno ad uno eseguendo prove tecniche e di conformità, anche quando non sono richieste dalle normative. Ogni prodotto costruito viene testato secondo le vigenti direttive in materia di sicurezza elettrica. Eseguiamo prove di rigidità, messa a terra, potenza e assorbimento. La cura del dettaglio ci permette di fare la differenza. Noi vogliamo farli meglio, unici ed esclusivi. Questo oggi è Amarcords, questo il vero made in Italy.

## Attention to detail

Anti Corodal 6061 aluminium with galvanic bath treatment in pure materials such as Gold, Silver, Berilio, Manganese, Platinum, Copper, Naval Brass. Manual brushing and finishing with transparent electropolishing. Each individual product is assembled by hand. This is what we do with our accessories to illuminate environments

## We are not satisfied with a simple lamp holder, we have to do it well

Our Edison E27 lampholders are designed and studied by our technicians and designers. They are composed of different parts, carefully assembled and galvanically treated in every single screw, ring nut or body. Internally, Bakelite guarantees maximum electrical performance. In addition, we have inserted a grounding bush to ensure the possibility of connection in Class 1.

## Coated cable is not enough, we also want to ensure the quality of fabrics and materials

We only use made in Italy cable in compliance with both CPR and EN 50525-2-11 standards. In Italy we look for and find the best yarns, the best silks, canapes and cottons. We cover our electrical cable in Italy with the utmost attention to detail and regulations.

## We do it better

We test them one by one, carrying out technical and conformity tests, in some cases beyond what is required by regulations. Each manufactured product is tested according to current electrical safety standards. We perform rigidity, grounding, power and absorption tests. Attention to detail helps us make a difference, we want to make them better, make them unique and not for everyone. This is Amarcords today, this is the true Made in Italy.

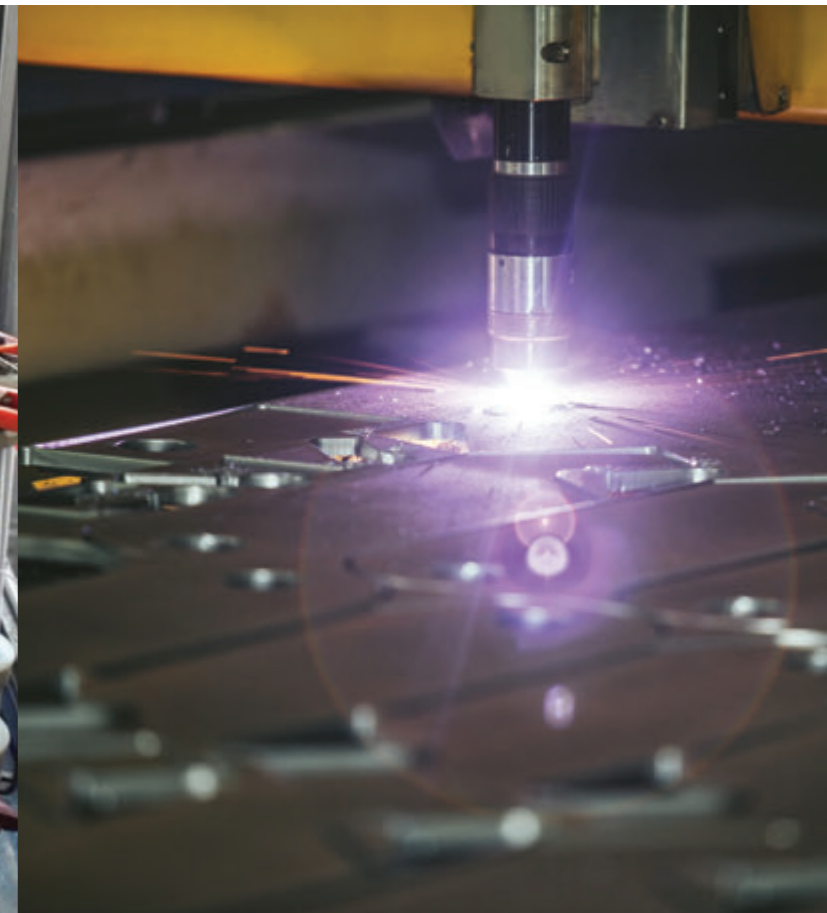
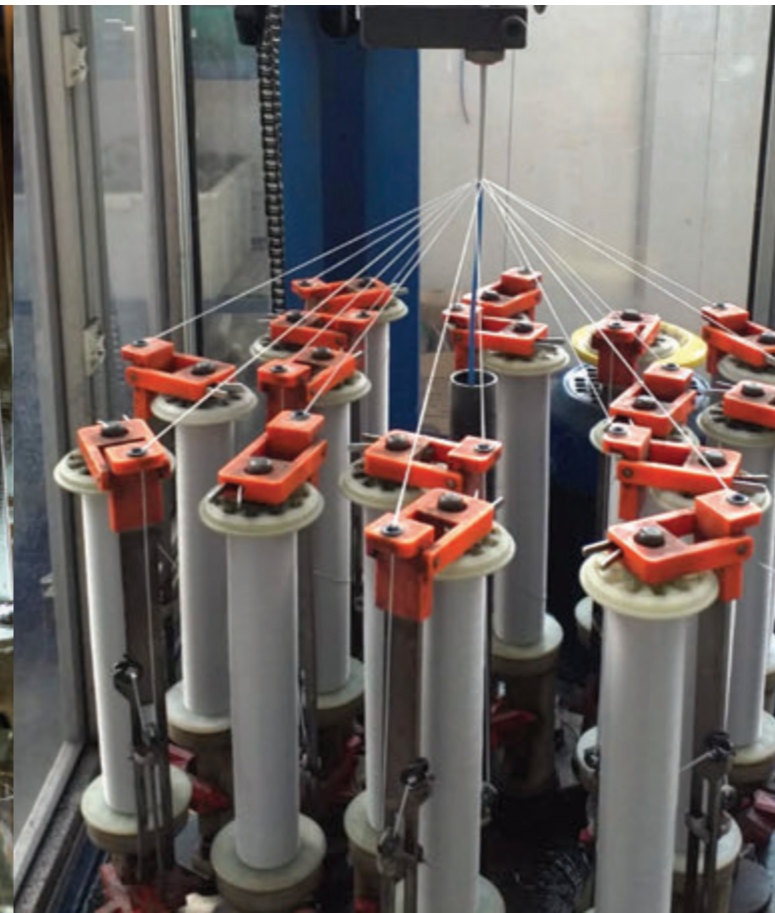

GLOSSARIO  
GLOSSARY

10000	176	AH115	142	AM705	109	AR146	153	AR328	151	AS110	43	ATD106	22	ATD204	20	ATD282	21	ATD900	55	AX505	156	AX704	157	DFUCK	128	EL125	136	FX902	175	QP668	68
10030	176	AH117	142	AP110	112	AR148	151	AR330	152	AS111	43	ATD107	22	ATD205	20	ATD283	21	ATD901	55	AX506	159	AX712	157	DL102	124	EL126	137	FX903	175	QP861	67
10040	176	AH118	142	AP113	112	AR150	152	AR332	152	AS112	43	ATD108	22	ATD206	20	ATD284	21	ATD902	55	AX508	156	AX713	157	DL120	124	EL127	137	GH020	144	QR411	58
10050	176	AH119	142	AP139	113	AR152	152	AR333	152	AS113	43	ATD109	22	ATD207	20	ATD285	21	ATD903	55	AX509	157	AX715	157	DL122	124	EL128	137	GH021	144	QR412	58
10060	176	AH120	142	AR010	176	AR153	152	AR334	153	AS114	43	ATD110	22	ATD208	20	ATD286	21	ATD904	55	AX510	157	AX716	160	DL125	123	EL129	137	GH022	144	QR413	58
10070	176	AH121	142	AR012	176	AR155	151	AR335	151	AS115	43	ATD111	22	ATD209	20	ATD287	21	ATD905	55	AX520	156	AX754	157	DL129	125	EL130	137	GH023	144	QR415	58
10100	176	AH123	142	AR013	176	AR157	153	AR337	153	AS116	43	ATD112	22	ATD210	20	ATD288	21	ATD906	55	AX530	157	AX762	157	DL130	125	EL131	136	GH024	144	QR418	58
10310	176	AH125	142	AR014	176	AR159	153	AR339	153	AS117	43	ATD113	22	ATD211	20	ATD289	21	ATD907	55	AX531	157	AX763	157	DL160	124	EL132	136	LB115	177	QR471	58
10401	176	AH127	142	AR016	151	AR161	152	AR340	152	AS118	43	ATD114	22	ATD212	20	ATD290	21	ATD908	55	AX534	159	AX765	157	DL162	123	EL133	136	LB116	177	QR472	58
10409	176	AH129	142	AR018	153	AR170	151	AR342	153	AS119	43	ATD115	22	ATD213	20	ATD291	21	ATD909	55	AX535	156	AX766	160	DL165	123	EL134	136	LB117	177	QR473	58
10500	176	AH131	142	AR020	153	AR171	151	AR347	153	AS120	43	ATD116	22	ATD214	20	ATD292	21	ATD910	55	AX536	156	AX900	149	DL167	124	EL135	136	LB700	127	QR475	58
10530	176	AH133	142	AR021	152	AR172	151	AR348	153	AS121	43	ATD117	22	ATD215	20	ATD293	21	ATD911	55	AX538	159	AX902	149	DL168	124	EL136	137	LB701	127	QR478	58
AC402	171	AH140	142	AR023	151	AR173	151	AR349	151	AS122	43	ATD118	22	ATD216	20	ATD294	21	ATD912	55	AX539	160	AX909	149	DL205	123	EL137	137	LB702	127	QR481	58
AC403	171	AH141	142	AR025	152	AR174	151	AR351	152	AS123	43	ATD119	22	ATD217	20	ATD295	21	ATD913	55	AX540	160	AX925	144	DL306	123	EL138	137	LB703	127	QR482	58
AC415	171	AH142	142	AR027	152	AR175	151	AR353	152	AS124	43	ATD120	18	ATD218	20	ATD296	21	ATD914	55	AX541	157	AX927	144	DL342	123	EL139	137	LB704	127	QR483	58
AC430	171	AH143	142	AR028	152	AR176	151	AR354	152	AS125	43	ATD121	18	ATD219	20	ATD297	21	ATD915	55	AX547	157	AX931	145	DL357	123	EL140	137	LB707	127	QR485	58
AC433	171	AH144	142	AR030	151	AR177	151	AR356	151	AS126	43	ATD122	18	ATD220	16	ATD298	21	ATD916	55	AX548	160	AX934	144	DL452	123	EL141	137	LB910	130	QR488	58
AC448	171	AH145	142	AR031	150	AR178	151	AR358	153	AS127	43	ATD123	18	ATD221	16	ATD299	21	ATD917	55	AX549	160	AX936	176	DL601	123	EL142	137	LB911	130	QR493	62
AC500	171	AH146	142	AR032	152	AR201	147	AR360	153	AS128	43	ATD124	18	ATD222	16	ATD300	17	ATD918	55	AX566	162	AX937	176	DL642	123	EL143	137	LB912	130	QR494	63
AC501	171	AH147	143	AR038	151	AR204	147	AR361	152	AS129	43	ATD125	18	ATD223	16	ATD301	17	ATD919	55	AX588	159	AX938	176	DL755	123	EL144	137	LB913	130	QR611	60
AC510	171	AH148	143	AR040	153	AR206	147	AR363	153	AS130	43	ATD126	18	ATD224	16	ATD302	17	ATD920	55	AX590	159	AX949	145	DL805	123	EL145	137	LB914	130	QR612	60
AC511	171	AH149	143	AR042	153	AR207	147	AR368	153	AS131	43	ATD127	18	ATD225	16	ATD303	17	ATD921	55	AX591	159	AX950	145	DLHOM	125	EL150	140	LB915	130	QR613	60
AC923	171	AH663	143	AR043	152	AR208	147	AR369	153	AS132	43	ATD128	18	ATD226	16	ATD304	17	ATD922	55	AX601	157	AX951	145	DLOVE	125	EL151	140	LB916	130	QR615	60
AC995	171	AH665	143	AR046	153	AR209	147	AR370	151	AS133	43	ATD129	18	ATD227	16	ATD305	17	ATD923	55	AX602	159	AX953	145	DS043	132	EL152	140	LB920	130	QR618	60
AG300	165	AH667	143	AR047	153	AR210	147	AR372	152	AS134	43	ATD130	18	ATD228	16	ATD306	17	ATD924	55	AX605	156	AX954	145	DS046	132	EL153	140	LB921	130	QR671	60
AG301	165	AH669	143	AR049	151	AR212	147	AR374	152	AS135	43	ATD131	18	ATD229	16	ATD307	17	ATD925	55	AX606	159	AX955	145	DS051	132	EL154	140	LB922	130	QR672	60
AG302	165	AH670	143	AR054	152	AR214	147	AR375	152	AS136	43	ATD132	18	ATD230	16	ATD308	17	ATD926	55	AX608	156	AX956	145	DS248	134	EL155	140	LB923	130	QR673	60
AG303	165	AH672	143	AR056	152	AR215	147	AR376	151	AS137	43	ATD133	18	ATD231	16	ATD309	17	ATD927	55	AX609	157	BT500	173	DS300	134	EL161	137	LB925	130	QR675	60
AG304	165	AH673	143	AR057	152	AR217	147	AR377	151	AS138	43	ATD134	18	ATD232	16	ATD310	17	ATD928	55	AX610	157	BT501	173	DS301	134	EL162	137	LB926	130	QR678	60
AG308	165	AH675	143	AR059	151	AR219	147	AR379	153	AS139	43	ATD135	18	ATD233	16	ATD311	17	ATD929	55	AX620	156	BT502	173	DS302	134	EL163	137	LB930	177	QR681	60
AG309	165	AH677	143	AR060	151	AR220	151	AR381	153	AS140	43	ATD136	18	ATD234	16	ATD312	17	ATD930	55	AX630	157	BT503	173	DS305	134	EL164	137	LB931	177	QR682	60
AG310	165	AH679	143	AR061	150	AR221	150	AR382	152	AS141	43	ATD137	18	ATD235	16	ATD313	17	ATD931	55	AX631	157	BT510	173	DS306	134	EL165	137	LB932	177	QR683	60
AG311	165	AH700	145	AR067	153	AR223	147	AR385	152	AS142	43	ATD138	18	ATD236	16	ATD314	17	ATD932	55	AX634	159	BT511	173	DS337	132	EL170	138	LB933	177	QR685	60
AG312	165	AH701	145	AR068	153	AR240	151	AR387	152	AS143	43	ATD139	18	ATD237	16	ATD315	17	ATD933	55	AX635	156	BT512	173	DS396	133	EL171	138	LB934	177	QR688	60
AG333	165	AH702	145	AR070	151	AR241	150	AR388	151	AS144	43	ATD140	12	ATD238	16	ATD316	17	ATD934	55	AX636	156	BT513	173	DS680	133	EL172	138	LB935	177	QR693	64
AG334	165	AH703	145	AR071	150	AR250	147	AR389	150	AS145	43	ATD141	12	ATD239	16	ATD317	17	ATD935	55	AX638	159	BT700	172	DS681	133	EL173	138	LB936	177	QR694	65
AG335	165	AH704	145	AR078	153	AR251	147	AR391	152	AS146	43	ATD142	12	ATD240	10	ATD318	17	ATD936	55	AX639	160	BT701	172	DS685	133	EL174	138	LB937	177	SA022	77
AG336	165	AH705	145	AR079	153	AR252	147	AR400	148	AS147	43	ATD143	12	ATD241	10	ATD319	17	ATD937	55	AX640	160	BT708	172	DS689	133	EL175	138	LB938	177	SA062	77
AG337	165	AH750	143	AR080	151	AR253	147	AR401	148	AS148	43	ATD144	12	ATD242	10	ATD320	11	ATD938	55	AX641	157	BT900	172	DS700	132	EL176	138	LB939	177	SA123	78
AG338	167	AH751	143	AR081	150	AR254	147	AR402	148	AS149	43	ATD145	12	ATD243	10	ATD321	11	ATD939	55	AX647	157	BT901	172	DS727	134	EL177	138	LB940	177	SA126	80
AG339	167	AH752	143	AR082	152	AR255	147	AR403	148	AS150	43	ATD146	12	ATD244	10	ATD322	11	ATD940	55	AX648	160	BT905	172	DS805	132	EL178	138	LB941	177	SA129	82
AG340	167	AH753	143	AR085	153	AR256	147	AR404	148	AS151	43	ATD147	12	ATD245	10	ATD323	11	ATD941	55	AX649	160	BT906	172	DS894	133	EL179	138	LB943	177	SA163	78
AG341	165	AH754	143	AR086	153	AR257	147	AR405	148	AS152	43	ATD148	12	ATD246	10	ATD324	11	ATD942	55	AX666	162	BT908	172	EL101	136	EL260	104	LB944	177	SA166	80
AG343	167	AH755	143	AR087	151	AR258	147	AR406	148	AS153	43	ATD149	12	ATD247	10	ATD325	11	ATD943	55	AX667	162	CA301	114	EL102	136	EL261	105	LB945	177	SA169	82
AG346	167	AH756	143	AR089	152	AR259	147	AR407	148	AS154	43	ATD150	12	ATD248	10	ATD326	11	ATD944	55	AX669	162	CA305									

SS413	93	TR718	30
SS414	93	TR771	30
SS611	91	TR772	30
TA201	53	TR773	30
TA202	53	TR775	30
TA611	54	TR778	30
TA612	55	TR781	30
TO410	20	TR782	30
TO411	21	TR783	30
TO470	16	TR785	30
TO471	17	TR788	30
TO480	10	TS471	48
TO481	11	TS472	49
TO610	22	TS473	49
TO611	23	TS477	48
TO670	18	TS478	48
TO671	19	TS491	50
TO680	12	TS492	51
TO681	13	TS493	51
TP402	43	TS497	50
TP602	44	TS498	50
TP603	45	TS811	47
TP612	40	TS871	47
TP613	41	TS881	47
TP614	42		
TP661	38		
TP662	38		
TP663	38		
TP665	38		
TP668	38		
TP861	37		
TR311	26		
TR312	26		
TR313	26		
TR315	26		
TR318	26		
TR371	26		
TR372	26		
TR373	26		
TR375	26		
TR378	26		
TR381	26		
TR382	26		
TR383	26		
TR385	26		
TR388	26		
TR393	32		
TR394	33		
TR611	28		
TR612	28		
TR613	28		
TR615	28		
TR618	28		
TR671	28		
TR672	28		
TR673	28		
TR675	28		
TR678	28		
TR681	28		
TR682	28		
TR683	28		
TR685	28		
TR688	28		
TR693	34		
TR694	35		
TR711	30		
TR712	30		
TR713	30		
TR715	30		

AMARCORDS



Graphic & 3D designer  
Daniele Campadelli  
daniele@amarCORDS.com

AMARCORDS



Graphic & 3D designer  
Daniele Campadelli  
daniele@amarcords.com

AmarCORDS S.r.l.  
Sede Legale: Via Aurelio Saffi, 21 - 20123 Milano  
Logistica e Uffici: Corso Sempione, 80/A - 20015 Parabiago (MI)  
Iscrizione al Registro Produttori AEE: IT15080000008984  
Tel.: 0331 49.20.54 - Fax: 02 45.50.39.92  
amarCORDS@amarCORDS.com  
P.IVA: 09021550968 - REA: MI-2063 204 - SDI: SUBM70N