

• **Elesi Luce**[®]

Materioteca

Materials library

Codici e simboli

Code and symbols

Finiture galvaniche / Galvanic finishes



AC
Acciaio spazzolato
Brushed steel

OF
Oro francese
French Gold

HT
High tech

Finiture materiche / Textured finishes



AL
Alluminio
Aluminium

FO
Foglia oro
Gold foil

Finiture verniciate / Painted finishes



AN
Alluminio spazzolato + nero
Brushed Aluminium + black

AS
Alluminio spazzolato
Brushed aluminium

BB
Bianco
White



BZ
Bronzo
Bronze

NR
Nero
Black

OL
Ottone lucido
Brass color

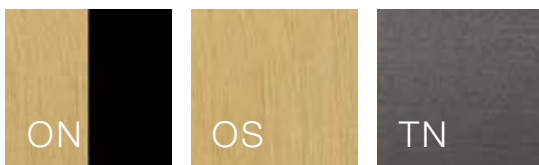

ON
Ottone spazzolato + nero
Brushed brass + black

OS
Ottone spazzolato
Brushed brass

TN
Titanio
Titanium

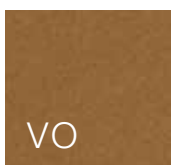

VO
Verniciato oro
Painted gold

Applicazione / Use pictograms



Applique
Wall lamp



Sospensione
Suspension lamp



Plafoniera
Ceiling lamp



Lampada da tavolo
Table lamp



Lampada da terra
Standing lamp



Incasso
Recessed light

Caratteristiche / Specific pictograms



LED tecnologia
Led technology



Certificazione CE
CE certification



Certificazione UL
UL certification



Lampadina (non inclusa)
Bulb (not included)



Dimmer a taglio di fase
Cut phase dimmer



Touch dimmer
Touch dimmer



Accensioni separate
Separate lighting



Interruttore on/off
On/off Switch



Dati fotometrici
Photometric data



File 3D
3d files



File BIM
BIM files



LED-Change system



Misure personalizzabili
Size customizable



Finiture personalizzabili
Finish customizable

Costruzione del codice / Code Construction

- Codice prodotto di 5 cifre**
Product code **02009**
- Finitura della struttura**
Structure finish **02009 OF**
- Sistema di dimmerazione**
Kind of dimmer **02009 OF D**
- Colore luce LED**
LED light color **02009 OF D W**
- Optica della lente**
Lens degree **02009 OF D W X**
- Grado di protezione IP**
IP rate **02009 OF D W X X**
- Finitura del diffusore**
Diffuser color **02009 OF D W X X NR**

HAND MADE

 **Elesi Luce**[®]

Catalogo / *Catalog*



Una famiglia, persone unite dalla grande passione per il nostro lavoro. Ogni lampada racchiude un'idea che prende forma con il tempo, lo studio e la progettazione per trasformare la materia in luce. Le mani creano con dedizione, pezzo dopo pezzo, l'elemento che illuminerà ambienti vicini e lontani.

A family, people united by a passion for their work. Each product embodies an idea that takes shape over time, through study and design, transforming material into light. Piece after piece, our dedicated hands create lighting elements for worldwide applications.



Le tappe del cambiamento

The stages of our development

2006

Certificazione ISO9001
ISO9001 Certification



2008

Inaugurazione della nuova sede
Inauguration of the new headquarters



2011

Brevetto sistema E-viva LED
E-viva LED system patented



2020

Magazzino automatico - Industria 4.0
Automatic warehouse - Industry 4.0



24 anni di storia

Dal 1997 progettiamo lampade efficienti e di design e questo, oltre ad essere il nostro lavoro, è anche la nostra passione. Negli anni siamo cresciuti, abbiamo innovato i processi produttivi e introdotto nuove tecnologie senza mai dimenticare quanto per noi sia importante rimanere fedeli alle nostre origini artigiane, alla cultura del territorio e alla sua impronta imprenditoriale. Per questo abbiamo scelto consapevolmente di produrre nel rispetto del “Made in Italy”.

“Ci piace pensare che le persone che acquistano i nostri prodotti condividano anche la nostra idea di luce”

24 years of history

We have been designing lighting products since 1997. It's a job we are passionate about. Over the years we have developed, innovating the production processes and introducing new technologies, never forgetting how important it is for us to stay true to our artisan origins, our local culture and its entrepreneurial tradition. This is why we have made a conscious decision to follow the “Made in Italy” philosophy.

“We like to think that the people who purchase our products also share our idea of light”



Il nostro DNA

PERSONE Siamo un'azienda, ma soprattutto siamo un gruppo di persone che creano, sviluppano e realizzano lampade per illuminare ambienti destinati a persone che abitano luoghi e spazi diversi, ciascuno con le proprie abitudini ed esigenze. Chi sceglie le lampade Elesi Luce non è un semplice cliente, ma una persona che condivide questa nostra visione.

ARTIGIANALITÀ Per noi è una vocazione. Tutte le nostre lampade vengono controllate nelle diverse fasi di realizzazione e assemblate a mano pezzo per pezzo con cura, passione e attenzione ai dettagli. Doniamo a ciascuna lampada l'unicità e la ricercatezza del «fatto a mano».

INNOVAZIONE Siamo curiosi per natura e crediamo di poter dare il nostro piccolo contributo per un futuro migliore. Per questo partecipiamo a incontri intersettoriali, a studi di ricerca con aziende e università del territorio, a eventi e corsi formativi. Appliciamo le competenze acquisite all'organizzazione dei processi aziendali, ai materiali e alle tecnologie utilizzate nei nostri prodotti e ai servizi che offriamo.

AMBIENTE Il rispetto per l'ambiente orienta Elesi Luce verso l'utilizzo di materiali durevoli, a basso impatto ambientale e riciclabili, con occhio sempre attento alla sicurezza dei dispositivi nelle varie fasi di vita dalla produzione alla spedizione, dall'installazione all'utilizzo.

“La sintesi di fatto a mano e innovazione”

Our DNA

PEOPLE We are a company, but above all we are a group of people who conceive, develop and manufacture lighting products for a whole range of different situations, each with their own characteristics and requirements. A customer who chooses Elesi Luce is not simply a customer but a person who has found a solution from among our products.

CRAFTSMANSHIP Craftsmanship is our vocation. All the products are checked at every manufacturing stage and are assembled by hand piece by piece with maximum care and attention to detail, giving each article the uniqueness and refined elegance typical of a handmade product.

INNOVATION We are curious and we are keen to make a contribution to a better future. We take part in cross-sector meetings, research studies with local companies and universities, events and training courses. We apply the skills acquired to organization of the company processes, to the materials and technologies used in our products, and to the services we offer.

ENVIRONMENT Elesi Luce's respect for the environment can be seen in the use of long-lasting recyclable materials with low environmental impact, always paying attention to safety at all stages, from production and shipment right through to installation and use.

“Bringing together artisan skills and innovation”



h cm 35

l cm 15

Elesi Creative Lab

Consideriamo il Elesi Creative Lab il luogo nel quale prende forma la nostra idea di progettazione sostenibile, green thinking, made in Italy e fatto a mano; Atelier contemporaneo nel quale le lampade vengono realizzate con la versatilità e qualità del “pezzo unico” e con la possibilità di personalizzare finiture e produzioni. Orientamento al tailor-made che significa, nella nostra visione, operare con una metodologia che miri alla creazione di soluzioni su misura, anche molto diverse per materiali, forme e dimensioni dalle collezioni presentate. Tutte le nostre lampade sono pensate per la soddisfazione delle esigenze funzionali ed estetiche dei clienti e per dare il giusto comfort visivo negli ambienti in cui le persone vivono e lavorano.

Elesi Creative Lab

We consider the Elesi Creative Lab the hub of our sustainable design project and green thinking, the birthplace of our made-in-Italy hand-crafted products; a contemporary atelier where we create our lights with the versatility and quality of unique pieces, with the option of customized production and finishes. Our tailor-made approach means that we adopt methods aimed at creating made-to-measure solutions which can be very different, in terms of materials, forms and dimensions, from the collections presented. All our lights are designed to meet the functional and aesthetic requirements of our customers and to provide the right visual comfort in environments where people live and work.

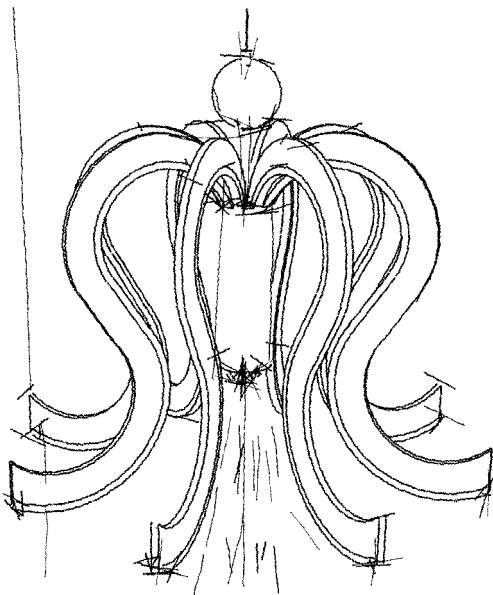

Green Thinking

“Diamo il nostro contributo per un presente e un futuro migliori aderendo agli obiettivi di Agenda2030”

“We make our contribution for a better present and future adhering to the objectives of Agenda2030”

- 3.** La luce partecipa al benessere psico-fisico degli essere viventi.
Progettiamo lampade che garantiscono comfort visivo negli ambienti in cui viviamo.
*Light participates in the psycho-physical well-being of living beings.
We design lamps that guarantee visual comfort in the environments in which we live.*
- 4.** Sosteniamo le competenze individuali con la formazione e collaborando con le scuole del territorio.
We support individual skills with training and education and collaborating with schools in our territory.
- 5.** Promuoviamo il dialogo con le persone nel rispetto reciproco.
We promote dialogue with people in mutual respect.
- 8.** Un ambiente di lavoro familiare, confortevole, dove sentirsi a proprio agio.
A familiar, comfortable work environment, where you can feel at ease.
- 9.** Il valore dell'artigianato in una organizzazione snella e 4.0.
The value of craftsmanship in a lean and 4.0 organization.
- 12.** I prodotti sono progettati per avere un basso impatto ambientale durante tutto il ciclo di vita: produzione, utilizzo, riparazione o riuso, riciclo.
The products are designed to have a low environmental impact throughout their life cycle: production, use, repair or reuse, recycling.
- 17.** Collaborazione tra aziende ed enti che condividono gli stessi obiettivi.
Collaboration between companies and organizations that share the same objectives.



LED-Change System

Ispirati dal “Green Thinking” e da un attento ascolto delle esigenze del Cliente, abbiamo sviluppato soluzioni innovative per una facile e immediata sostituzione della sorgente a LED direttamente sul luogo di installazione. Questo per noi è “LED-Change System”: tecnologie che aumentano il ciclo di vita del prodotto e ne diminuiscono l’impatto ambientale, una azione concreta per salvaguardare il mondo che ci ospita.

Inspired by “Green Thinking” and by listening carefully to customer needs, we have developed innovative solutions for simple immediate LED replacement directly on site. Our LED-Change System features technologies that prolong the product life cycle and reduce environmental impact, a concrete step towards safeguarding the world we inhabit.

Questo è il simbolo che contrassegna le lampade a led integrati dotate di “LED-Change System”. Per queste lampade sono previsti kit di sostituzione LED contenenti le istruzioni che consentono al tecnico specializzato una rapida e semplice intervento.

This is the symbol that marks our integrated LED lights with LED-Change System. These lights are provided with LED replacement kits containing instructions for quick simple intervention by qualified technicians.



Vantaggi:

- Assistenza facile e immediata
- Diminuzione dei costi
- Riduzione dei rifiuti
- Aumento del ciclo di vita del prodotto

Advantages:

- Easy immediate support
- Reduction of costs
- Reduction of waste
- Longer product life cycle

“Il sistema che consente la sostituzione del LED”

“The easy LED replacement system”

Racconti di luce

Stories of Light

*“È la bellezza un raggio
di chiarissima luce
che non si può ridir quanto riluce
né pur quel ch'ella sia.*

(Torquato Tasso - poeta)”

*“Beauty is a ray of light
so clear you cannot explain
how luminous it is
or even what it is”*

(Torquato Tasso - poet)



La filosofia descrive la luce come ciò che permette di vedere, di distinguere le forme, la profondità della realtà. E' la luce che rivela e svela; ciò che non è illuminato non ci è dato di conoscere. Ogni nostro prodotto racchiude una storia, fatta di passione, competenza ed innovazione. Ogni collezione ha la sua personalità, il proprio DNA. Per questo abbiamo pensato di invitarvi a fare un viaggio con noi, attraverso le storie che ogni giorno ci accompagnano.

According to philosophy, light is what enables us to see, to distinguish forms and the depth of reality. Light reveals and unveils; we have no way of knowing what is not illuminated. Each of our products tells a story of passion, competence and innovation. Each collection has its own personality, its own DNA. This is why we have invited you to come on a journey with us, through the stories that accompany us daily.



Storie di effetti / *Stories of effects*



Gaia Pg. 18



Alba Pg. 48



Iconic Pg. 54



Quid Pg. 70

Storie di riflessi / *Stories of reflections*



Like Q Pg. 82



Real Pg. 94



Bemit Pg. 100



Rondaj Pg. 110

Storie di trasparenze / *Stories of transparencies*



Air Pg. 120



Tour Pg. 134



Versailles Pg. 146

Storie di alchimie / *Stories of alchemy*

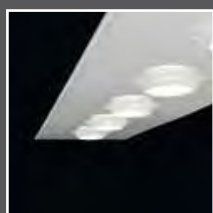

Pois Pg. 156



Mir Pg. 172



Aura Pg. 180

Storie di accenti / *Stories of accents*



Piston Pg. 192



Techno Pg. 200



Doc Pg. 208

Storie di geometrie / *Stories of geometries*



Klaro Pg. 218



Dado Pg. 228



Kant Pg. 238

Storie di accordi / *Stories of chords*



E-Viva Pg. 250

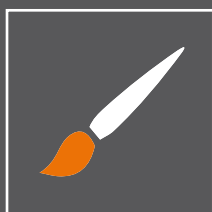

La tua storia di luce

Creiamo soluzioni speciali di illuminazione: dalla personalizzazione della finitura alla realizzazione di lampade su progetto.

Your stories of light

We create special lighting solutions: from the customization of the finish to the production of customized lamps.

Storie di effetti

*“L’Architettura è il gioco
sapiente, rigoroso e magnifico
dei volumi sotto la luce.”*

(Le Corbusier - Architetto)

Stories of effects

*“Architecture is the learned game,
correct and magnificent,
of forms assembled in the light.”*

(Le Corbusier - Architect)



La luce interagisce con la materia, creando dei fenomeni attraverso i quali gli oggetti si rivelano ai nostri occhi. Storie di Effetti raccontano di collezioni dove la luce e la materia creano effetti evocativi, plasmando gli spazi nei quali sono inseriti. Qui la trama della storia diventa emozione da vivere.

Light interacts with matter, creating phenomena through which objects are revealed to our eyes. Stories of Effects describe collections where light and matter create evocative effects, modelling the spaces they occupy. Here the story plot becomes an emotion waiting to be experienced.



Gaia

Designer: Alessandro Todesco

“Emozioni e sensazioni armoniche”
“*Harmony of emotions and sensations*”



DESIGN Forma semplice arricchita dal gioco di pieni e di vuoti, Gaia dona all'ambiente piacevoli effetti luminosi che creano una atmosfera dinamica. Un gioco di luce che suscita emozioni e sensazioni armoniche.

DESIGN A simple shape enhanced by the interplay between solids and voids, Gaia creates interesting lighting effects and a dynamic atmosphere. A play of light that evokes a harmony of emotions and sensations.



PERSONALITÀ E' una lampada dalla vocazione Green: efficienza del led integrato, scelta di materiali riciclabili, lungo ciclo di vita. Leggera e resistente, il suo corpo è in alluminio. La luce viene plasmata attraverso i tagli laser 3D esaltandone la forma.

PERSONALITY A product with a green vocation: integrated LED efficiency, recyclable materials, long life cycle. Lightweight and strong, with aluminium body. The light is shaped by the 3D laser cuts, enhancing its form.



MAESTRIA La finitura bronzo è eseguita artigianalmente con 3 passaggi di colore per creare l'effetto bicolore con l'interno oro e l'esterno bronzo. La lavorazione bronzo è eseguita a mano, rendendo unica ogni lampada.

EXPERTISE The bronze finish is the result of 3 colour passes to create the two-colour effect with the gold interior and bronze exterior. This process is carried out by hand, making each product unique.







BZ - Bronzo La finitura bronzo è eseguita artigianalmente con 3 passaggi di colore per creare l'effetto bicolore con l'interno oro e l'esterno bronzo.

BZ - Bronze *The bronze finish is the result of 3 colour passes to create the two-colour effect with the gold interior and bronze exterior.*



TN - Titanio Il colore Titanium è un grigio scuro con tonalità calda. Accesa la luce illumina l'interno della lampada creando un effetto bicolore.

BZ - Titanium *The Titanium color is a dark gray with a warm hue. When turned on, the light illuminates the interior of the lamp, creating the two-colour effect.*



BB - Bianco Il colore bianco trova la sua naturale esaltazione negli ambienti con le pareti colorate. Installata su pareti bianche la lampada si integra nell'ambiente, per evidenziare la sua personalità quando viene accesa.

BB - White *The white color finds its natural exaltation in the rooms with colored walls. Installed on white walls, the lamp integrates into the surroundings, to highlight its personality when it is turned on.*



Art 04401 TN (Version GU10 Art 04431 TN)



Art 04402 BZ (Version E27 Art 04432 BZ)





Art 04406 TN



Art 04405 BB



Art 04406 BZ





Art 04407 BZ (Version GU10 Art 04437 BZ)



Art 04409 BB (Version GU10 Art 04439 BB)

04401

Suspension
12 W
1650 Lumen
CRI90



04402

Suspension
12 W
1650 Lumen
CRI90

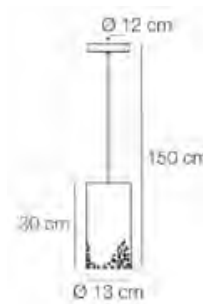

04405

Wall lamp
12 W
1650 Lumen
CRI90

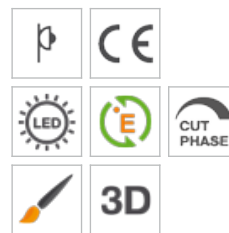
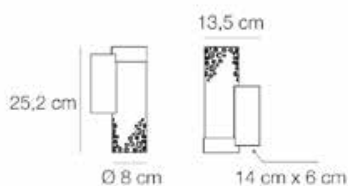

04406

Wall lamp
2 x 12 W
2 x 1650 Lumen
CRI90

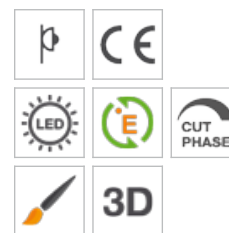
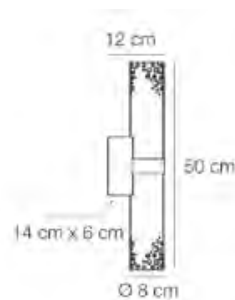

Structure	Dimmer	Led Light	Lens	IP	Diffuser
BB	D (Dimmer)	H 2700 K	X (No lens)	X (IP20)	XX
BZ		W 3000 K	4 (45°)		
TN		N 4000 K			

04407

Ceiling lamp
12 W
1650 Lumen
CRI90

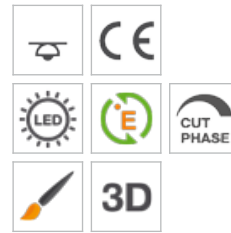
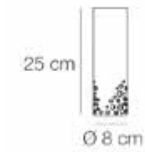

04409

Ceiling lamp
6 W
825 Lumen
CRI90

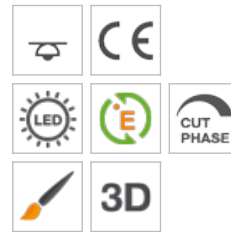
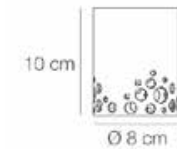

Structure	Dimmer	Led Light	Lens	IP	Diffuser
BB	D (Dimmer)	H 2700 K	X (No lens)	X (IP20)	XX
BZ		W 3000 K	4 (45°)		
TN		N 4000 K			



Art 04413 BZ (Version GU10 Art 04443 BZ)



Art 04415 TN (Version GU10 Art 04445 TN)



Art 04412 BB (Version GU10 Art 04442 BB)

04412

Suspension
 3x12 W
 3x1650 Lumen
 CRI90
 On request: Dali - 0/10V

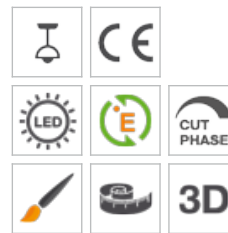
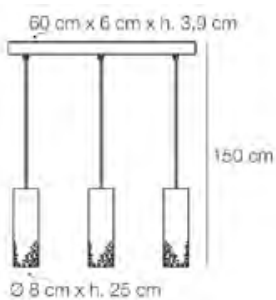

04414

Suspension
 4x12 W
 4x1650 Lumen
 CRI90
 On request: Dali - 0/10V

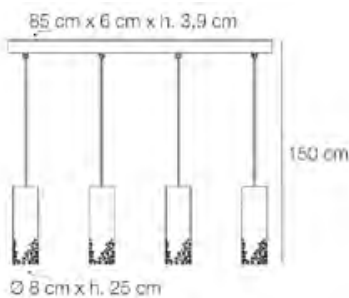

04413

Suspension
 3x12 W
 3x1650 Lumen
 CRI90
 On request: Dali - 0/10V

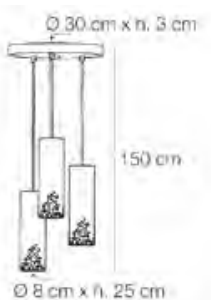

04415

Suspension
 5x12 W
 5x1650 Lumen
 CRI90
 On request: Dali - 0/10V

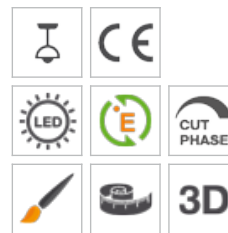

Structure	Dimmer	Led Light	Lens	IP	Diffuser
BB	D (Dimmer)	H 2700 K	X (No lens)	X (IP20)	XX
BZ		W 3000 K	4 (45°)		
TN		N 4000 K			



Art 04501 TN (Version G9 Art 04531 TN)





Art 04502 BZ (Version E14 Art 04532 BZ)



Art 04503 TN (Version E14 Art 04533 TN)



Art 04506 BZ (Version E14 Art 04536 BZ)



Art 04504 TN (Version G9 Art 04534 TN)



Art 04505 BZ (Version E14 Art 04535 BZ)



Art 04507 BZ (Version G9 Art 04537)

04501

Suspension
24 W
3500 Lumen
CRI90
On request: Dali - 0/10V

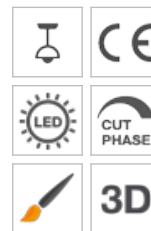
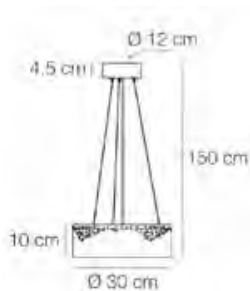

04502

Suspension
42 W
6100 Lumen
CRI90
On request: Dali - 0/10V

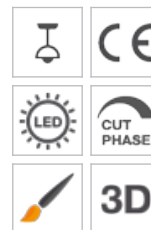

04503



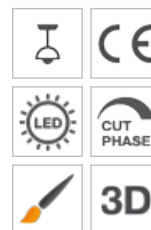
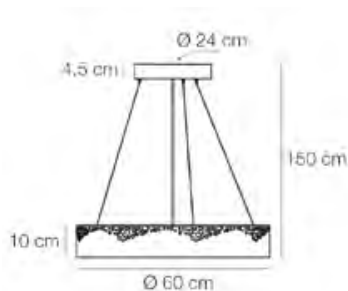

Suspension
59 W
8800 Lumen
CRI90
On request: Dali - 0/10V

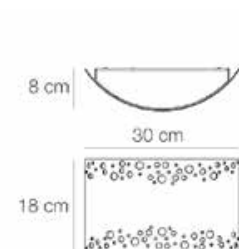

04507

Wall light
17,2 W
2450 Lumen
CRI90



Structure	Dimmer	Led Light	Lens	IP	Diffuser
BZ 	D (Dimmer)	H 2700 K 	X (No lens)	X (IP20)	XX
TN 		W 3000 K 			
		N 4000 K 			

04504

Ceiling lamp
 24 W
 3500 Lumen
 CRI90
 On request: Dali - 0/10V



04505



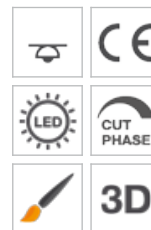
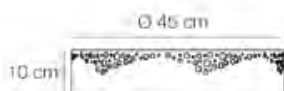

Ceiling lamp
 42 W
 6100 Lumen
 CRI90
 On request: Dali - 0/10V

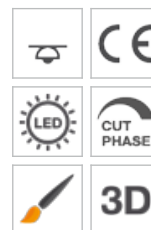

04506

Ceiling lamp
 59 W
 8800 Lumen
 CRI90
 On request: Dali - 0/10V



Structure	Dimmer	Led Light	Lens	IP	Diffuser
BZ 	D (Dimmer)	H 2700 K 	X (No lens)	X (IP20)	XX
TN 		W 3000 K 			
		N 4000 K 			



04431 (04401 Bulb version)

Suspension Ø 8 cm
GU10 1x max 7 W



04432 (04402 Bulb version)

Suspension Ø 13 cm
E27 1x max 13 W



04437 (04407 Bulb version)

Ceiling Lamp Ø 8 cm
GU10 1x max 7 W



04439 (04409 Bulb version)

Ceiling Lamp Ø 8 cm
GU10 1x max 7W



04442 (04412 Bulb version)

Suspension
GU10 3x max 7 W



04443 (04413 Bulb version)

Suspension
GU10 3x max 7 W



04444 (04414 Bulb version)

Suspension
GU10 4x max 7 W



04445 (04415 Bulb version)

Suspension
GU10 5x max 7 W



Structure	Dimmer	Led Light	Lens	IP	Diffuser
BB BZ TN	X (No planned)	X (No planned)	X (No planned)	X (IP20)	XX (No planned)



04531 (04501 Bulb version)

Suspension Ø 30 cm
G9 5x max 5 W



04532 (04502 Bulb version)

Suspension Ø 45 cm
E14 6x max 5 W



04533 (04503 Bulb version)

Suspension Ø 60 cm
E14 8x max 5 W



04534 (04504 Bulb version)

Ceiling Lamp Ø 30 cm
G9 5x max 5 W



04535 (04505 Bulb version)

Ceiling Lamp Ø 45 cm
E14 6x max 5 W



04536 (04506 Bulb version)



Ceiling Lamp Ø 60 cm
E14 8x max 5 W



04537 (04507 Bulb version)

Wall lamp
G9 4x max 5 W G9 5x max 5 W



Structure	Dimmer	Led Light	Lens	IP	Diffuser
BZ 	X (No planned)	X (No planned)	X (No planned)	X (IP20)	XX (No planned)
TN 					

Alba

Designer: Roberto De Santi

“La luce che disegna la forma”
“*Light designs form*”



DESIGN Alba rappresenta l'intimo legame tra luce e forma. La figura di appartenenza, il cerchio, non si conclude nella forma tangibile ma si dilata nello spazio.

DESIGN Alba represents the intimate link between light and form. The design is based on a circle, an incomplete figure stretching into space.



PERSONALITÀ L'effetto creato dalla lampada richiama il valore ancestrale della luce nel suo apparire. Una forma sospesa e leggera che si esalta con la luce. I led integrati ad alta efficienza e l'alluminio riciclabile la rendono una lampada a basso impatto ambientale.

PERSONALITY The effect created recalls the ancestral values of light as it appears at dawn. A suspended lightweight form enhanced by light. The high efficiency integrated LEDs and the recyclable aluminium make it a product with a low environmental impact.



MAESTRIA Per esaltare il colore naturale della luce, la parte interna della lampada è sempre color bianco. La rifinitura esterna può essere personalizzata.

EXPERTISE To enhance the natural colour of the light, the inner part of the lamp is always white. The outer finish can be customized.











Art 05001 OL

05001

Suspension 120cm
 12 up - 23 down W
 1700 up-3300 down Lumen
 CRI90



05002

Suspension 180m
 18 up-34 down W
 2550 up-4900 down Lumen
 CRI90



Structure	Dimmer	Led Light	Lens	IP	Diffuser
BB <input type="checkbox"/>	D (Dimmer)	H 2700 K <input checked="" type="radio"/>	X (No lens)	X (IP20)	BB <input type="checkbox"/>
NR <input type="checkbox"/>		W 3000 K <input checked="" type="radio"/>			
OL <input type="checkbox"/>		N 4000 K <input type="radio"/>			

Iconic

Designer: Simone Bellicini

“L’equilibrio di figure essenziali”
“*The balance of essential figures*”



DESIGN Un incontro di forme essenziali. Attraverso una meccanica di precisione, un cilindro, un cono e una sfera si fondono per creare un elemento di design raffinato e iconico.

DESIGN *A meeting of essential forms. Precision engineering helps to blend a cylinder, a cone and a sphere to create an elegant iconic design element.*



PERSONALITÀ Iconic illumina gli ambienti rispecchiando il tuo stile grazie ai suoi elementi modulari che permettono di realizzare soluzioni personalizzate. L’alluminio riciclabile della struttura e il led integrato la rendono a tutti gli effetti una lampada sostenibile.

PERSONALITY *With its modular elements that allow customized solutions, Iconic reflects your style. The recyclable aluminium structure and integrated LED make this a sustainable lighting product.*



MAESTRIA La cura nel dettaglio si esprime nell’alluminio e ottone attraverso la spazzolatura del metallo eseguita completamente a mano. Quell’artigianalità che conferisce unicità a ciascuna lampada.

EXPERTISE *Attention to detail in the 100% hand-brushed aluminium and brass, an artisan touch that makes each product unique.*







Art 04708 ON





Art 04707 AN



Art 04704 ON



Art 04702 BB



Art 04702 ON



Art 04701 AN



Art 04703 NR



Art 04706 AN





Art 04705 BB

Configurabile

Iconic è stato pensato come elemento basilare che può essere inserito in molteplici soluzioni illuminotecniche. Oltre alle proposte presenti, si possono creare combinazioni su misura per disegnare il proprio ambiente Iconic.

Configurable

Iconic was conceived as a basic element that can be inserted in multiple lighting solutions. In addition to the proposals in this catalog, you can create tailor-made combinations to design your own Iconic space.



Per una soluzione personalizzata contatta il nostro ufficio tecnico.

For a customized solution please contact our technical department.



04701

Suspension
7,3 W
1100 Lumen
CRI90

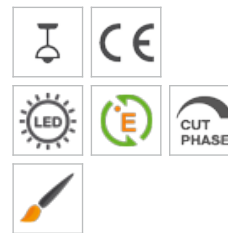
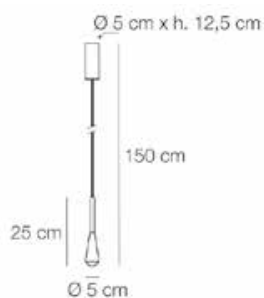

04702

Wall lamp
6,7 W
900 Lumen
CRI90

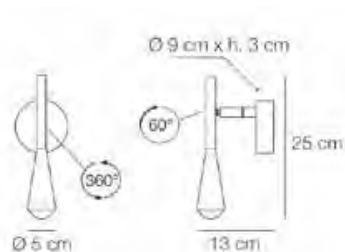

04703



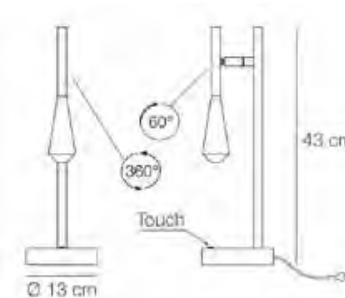



Table lamp
6,7 W
900 Lumen
CRI90

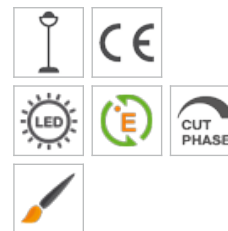
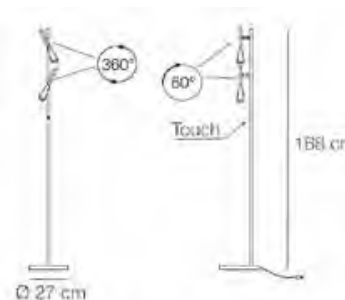

04704

Floor lamp
2x6,7 W
2x900 Lumen
CRI90



Structure	Dimmer	Led Light	Lens	IP	Diffuser
AN 	D (Dimmer)	H 2700 K 	X (No lens)	X (IP20)	XX
BB 		W 3000 K 			
NR 		N 4000 K 			
ON 					

04705

Suspension
 3x5 W
 3x650 Lumen
 CRI90
 On request: Dali - 0/10V



04706

Suspension
 5x5 W
 5x650 Lumen
 CRI90
 On request: Dali - 0/10V

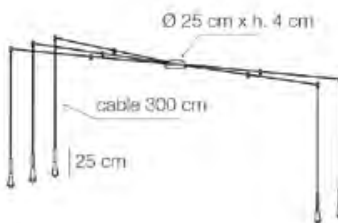

04707

Suspension
 6x5 W + 1x3 W
 6x650 + 1x400 Lumen
 CRI90
 On request: Dali - 0/10V



04708

Suspension
 8x5 W + 1x3 W
 8x650 + 1x400 Lumen
 CRI90
 On request: Dali - 0/10V



Structure	Dimmer	Led Light	Lens	IP	Diffuser
AN	D (Dimmer)	H 2700 K	X (No lens)	X (IP20)	XX
BB		W 3000 K			
NR		N 4000 K			
ON					

Quid

Designer: Maurizio Betteto

“Lineare e funzionale”
“*Linear and functional*”



DESIGN In omaggio ad un rigore stilistico dato dalle forme sobrie del design contemporaneo è nata Quid, una collezione di lampade dalle linee squadrate ed essenziali.

DESIGN *Quid, a collection of lights with square clean-cut lines, is a tribute to the rigorous style created by the essential forms typical of modern design.*



PERSONALITÀ Volumi compatti per una illuminazione funzionale, con luce diretta e indiretta. Le due parti in alluminio sono separate da un elemento in plexiglass (PMMA) che si illumina intorno al perimetro, donando ulteriore leggerezza alla sua forma.

PERSONALITY *Compact volumes for functional lighting, with direct and indirect light. The two aluminium parts are separated by a Plexiglas (PMMA) element that lights up around the perimeter, adding to the soft delicate effect of the design.*



MAESTRIA La finitura in foglia oro è eseguita a mano su tutte le parti metalliche, donando a Quid l'unicità e la ricercatezza del «fatto a mano».

EXPERTISE *The gold leaf finish is hand-done on all the metal parts, giving Quid the uniqueness and refined elegance typical of a handmade product.*







Art 02806 FO



Art 02807 NR



Art 02809 BB



Art 02810 BB



Art 02810 OF



Art 02818 BB



Art 02819 NR

02806

Suspension
 22 up - 22 down W
 3250 up-3250 down Lumen
 CRI90
 On request: Dali - 0/10V

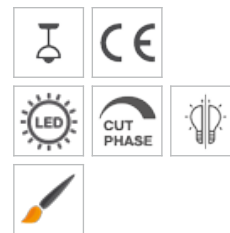

02807

Suspension
 34 up - 34 down W
 4900 up-4900 down Lumen
 CRI90
 On request: Dali - 0/10V

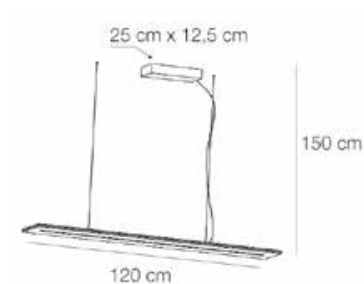

02809

Wall lamp
 4,8 up - 1,6 down W
 680 up - 220 down Lumen
 CRI90

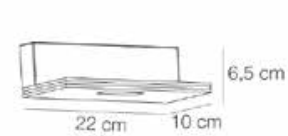

02810

Wall lamp
 9,7 up - 3,2 down W
 1360 up - 440 down Lumen
 CRI90

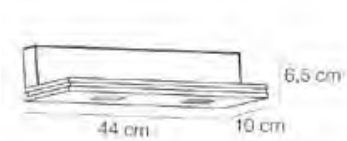

Structure	Dimmer	Led Light	Lens	IP	Diffuser
BB <input type="checkbox"/>	D (Dimmer)	H 2700 K <input checked="" type="radio"/>	X (No lens)	X (IP20)	XX
FO <input checked="" type="checkbox"/>		W 3000 K <input checked="" type="radio"/>			
NR <input checked="" type="checkbox"/>		N 4000 K <input type="radio"/>			

02818

Floor lamp
 37,9 up - 3,2 down W
 5100 up - 450 down Lumen
 CRI90

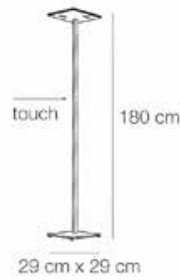

02819

Floor lamp
 37,9 up + 4,5 down W
 5100 up+444 down Lumen
 CRI90

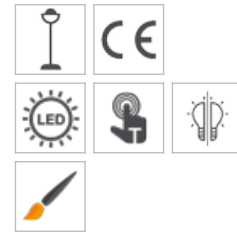
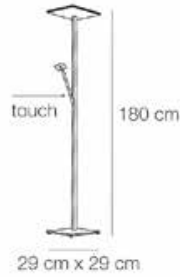

Structure	Dimmer	Led Light	Lens	IP	Diffuser
BB <input type="checkbox"/>	T (Touch)	H 2700 K	X (No lens)	X (IP20)	XX
NR <input type="checkbox"/>		W 3000 K			
	N 4000 K				

Storie di riflessi

“Il riflesso è per i colori quello che l’eco è per i suoni.”

(Joseph Joubert - Filosofo)

Stories of reflections

“Reflection is to colours what echo is to sounds.”

(Joseph Joubert - Philosopher)

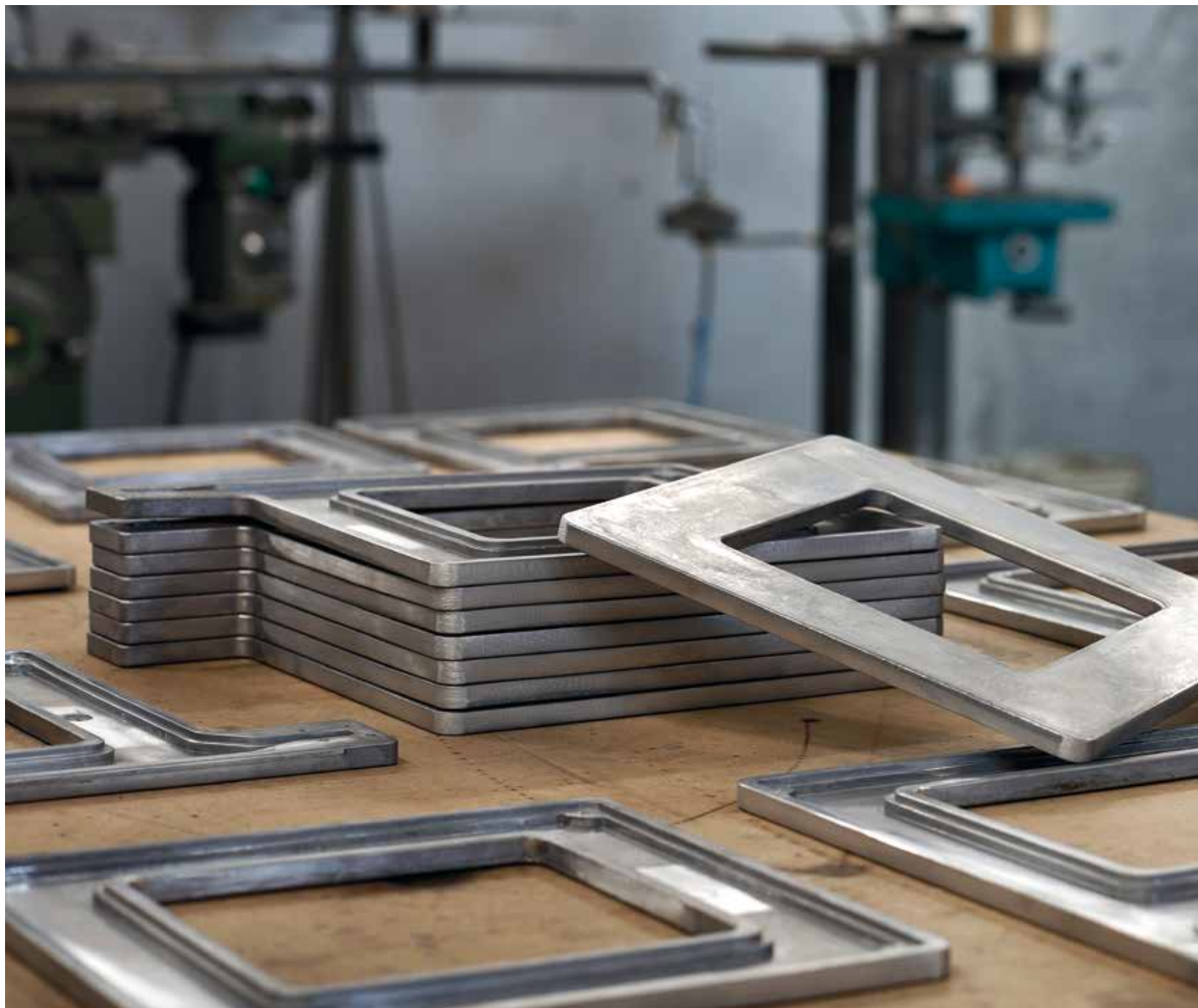

Luce riflessa è quell'effetto che si ottiene quando la luce colpisce una superficie lucida che la scompone e la diffonde, creando effetti carichi di poesia. Storie di riflessi racchiudono lampade che sono oggetti di design che illuminandosi diffondono una luce avvolgente e morbida.

Light interacts with matter, creating phenomena through which objects are revealed to our eyes. Stories of Effects describe collections where light and matter create evocative effects, modelling the spaces they occupy. Here the story plot becomes an emotion waiting to be experienced.



Like Q

Designer: Maurizio Betteto

“Proprio Come te”
“Just Like You”



DESIGN Forma semplice, senza spigoli, costruita con materiali nobili ma utilizzati in modo sobrio, e quel pizzico di sale per darci il giusto sapore: la dinamicità. Il movimento che consente di creare diversi effetti di luce, atmosfere che cambiano con un semplice tocco della mano.

DESIGN Essential shape, rounded corners, noble materials used simply and elegantly. The structure can be moved by a simple touch of the hand, creating different lighting effects and atmospheres, and adding a dynamic flavour.



PERSONALITÀ Le diverse combinazioni di colore conferiscono a Like Q una grande capacità di adattarsi ai diversi stili di arredamento. Il diffusore in vetro riflette la luce in modo morbido e avvolgente. L'alluminio riciclabile e il led integrato con LED-change system rendono Like Q una lampada rispettosa dell'ambiente.

PERSONALITY The different colour combinations give Like Q great scope for adapting to different furnishing styles. The glass reflector creates a soft suffused ambience. The recyclable aluminium and the integrated LED with green design system make Like Q an environment-friendly product.



MAESTRIA Il vetro, che rimanda alla tradizione del territorio, è utilizzato come superficie riflettente perché diffonde la luce in modo omogeneo e morbido. La finitura in foglia oro sul vetro è eseguita a mano, donando a Like Q l'unicità e la ricercatezza del «fatto a mano».

EXPERTISE The glass, a reminder of local tradition, is used as a reflecting surface diffusing the light softly and uniformly. The gold leaf finish on the glass is hand-done, giving Like Q the uniqueness and refined elegance typical of a handmade product.







Art 04601 AS_BB

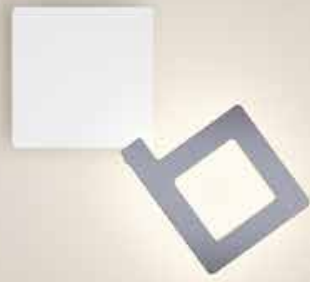

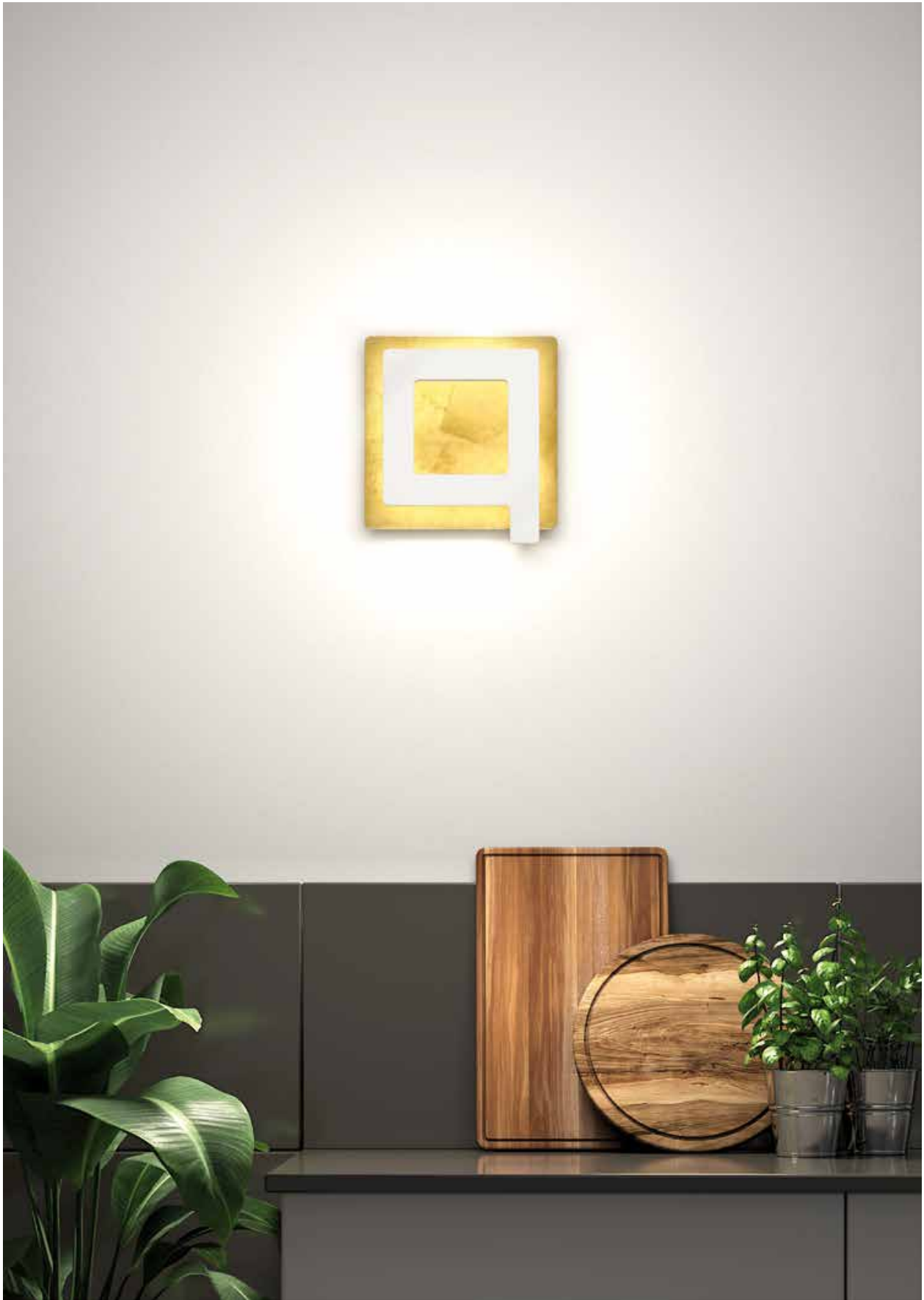

Art 04602 BB_FO



Art 04602 NR_FO



Art 04603 AS_BB



Art 04604 AS_BB



Art 04607 OS_BB



Art 04608 OS_BB

04601

Wall lamp
12 W
1750 Lumen
CRI90

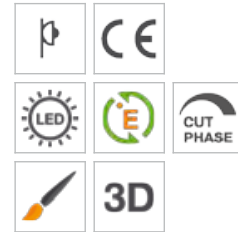
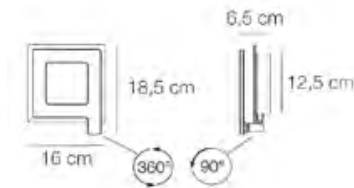

04602

Wall lamp
25 W
3650 Lumen
CRI90

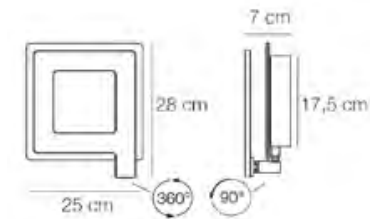

04603

Ceiling lamp
17 W
2230 Lumen
CRI90

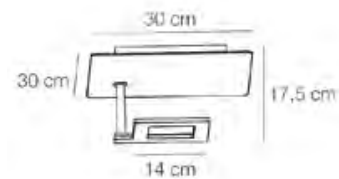

04604

Ceiling lamp
25 W
3650 Lumen
CRI90

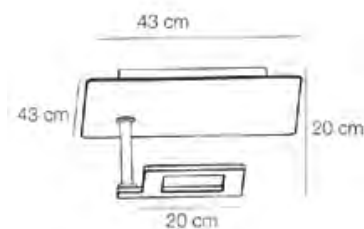

Structure	Dimmer	Led Light	Lens	IP	Diffuser
AS	D (Dimmer)	H 2700 K	X (No lens)	X (IP20)	BB
BB		W 3000 K			FO
NR		N 4000 K			
OS					
TN					

04607

Ceiling lamp
34 W
4460 Lumen
CRI90

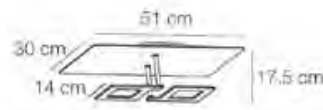

04608

Ceiling lamp
50 W
7300 Lumen
CRI90

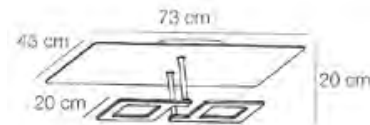

Structure	Dimmer	Led Light	Lens	IP	Diffuser
AS	D (Dimmer)	H 2700 K	X (No lens)	X (IP20)	BB
BB		W 3000 K			FO
NR		N 4000 K			
OS					
TN					

Real

Designer: Maurizio Betteto

“Un design a geometrie inverse”
“Inverse geometry design”



DESIGN Una forma decisa, nata da un gioco di geometrie tra materiali diversi: il vetro e l'alluminio. La collezione a led integrati illumina l'ambiente con luce indiretta e diffusa.

DESIGN A decisive form, resulting from a play of geometries between different materials: glass and aluminium. This integrated LED collection creates indirect diffuse lighting effects.



PERSONALITÀ Temperamento magnetico: Il diffusore in vetro è fissato con un sistema a calamite che consente una installazione rapida e agevole. Le linee morbide diventano elemento d'arredo che donano personalità all'ambiente, sia esso classico o contemporaneo.

PERSONALITY Magnetic temperament: the glass reflector is fixed by a magnet system allowing quick easy installation. The soft lines become a furnishing element, giving the room personality, whether classic or contemporary.



MAESTRIA I due elementi in alluminio sono originate da una unica lastra di alluminio, tagliata al laser e sagomati secondo un design a geometrie inverse. Il vetro, che rimanda alla tradizione del territorio, è utilizzato come superficie riflettente perché diffonde la luce in modo omogeneo e morbido.

EXPERTISE The two aluminium elements are obtained from one single aluminium sheet, laser cut and shaped according to an inverse geometry design. The glass, a reminder of local tradition, is used as a reflecting surface diffusing the light softly and uniformly.







Art 01602 OS_FO



Art 01603 NR_BB



Art 01602 AL_BB

01601

Ceiling / Wall lamp
6 W
930 Lumen
CRI90

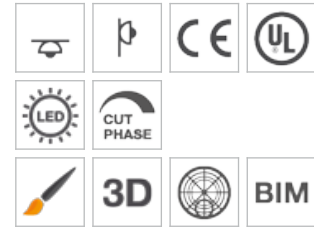
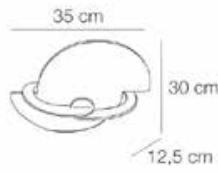

01602

Ceiling / Wall lamp
12 W
1860 Lumen
CRI90

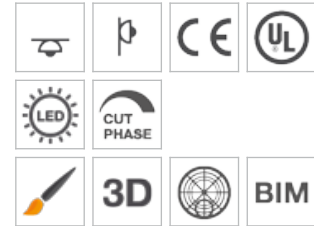
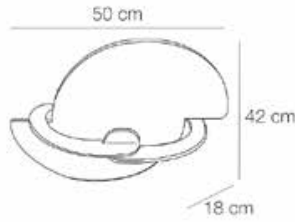

01603

Ceiling / Wall lamp
24,3 W
3480 Lumen
CRI90

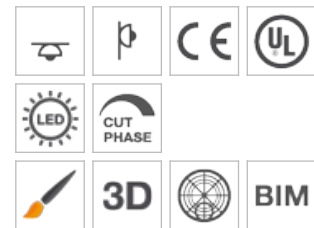
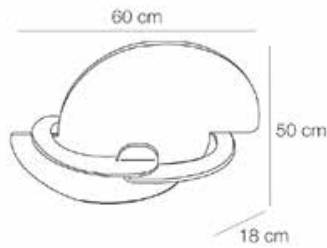

Structure	Dimmer	Led Light	Lens	IP	Diffuser
AL	D (Dimmer)	H 2700 K	X (No lens)	X (IP20)	BB
NR		W 3000 K			FO
OS		N 4000 K			

Bemit

Designer: Maurizio Betteto

“L’incontro che illumina”
“A meeting that illuminates”



DESIGN Una forma geometrica semplice, la metafora di un abbraccio che crea luce. Il nome «Be Mit» nasce dalla fusione di due lingue (l'inglese «Be» e il tedesco «Mit») ed evoca l'incontro dato dai due bracci in metallo che generano la luce.

DESIGN A simple geometric shape, the metaphor of an embrace that creates light. The name «Be Mit» is a fusion of two languages (the English «Be» and the German «Mit») and evokes the meeting of the two metal arms that generate the light.



PERSONALITÀ Con la sua linea minimale si adatta agli spazi, donando eleganza e raffinatezza: la sua luce diffusa esalta i soffitti e la profondità dello spazio. Temperamento magnetico: Il diffusore in vetro è fissato con un sistema a calamite che consente una installazione rapida e agevole.

PERSONALITY With its minimalist line it adapts to all spaces, adding elegance and refinement: the diffuse light enhances the ceiling and creates spatial depth. Magnetic temperament: the glass reflector is fixed by a magnet system allowing quick easy installation.



MAESTRIA Il vetro, che rimanda alla tradizione del territorio, è utilizzato come superficie riflettente che permette la diffusione di luce in modo omogeneo e morbido. La finitura in foglia oro sul vetro è eseguita a mano, donando a Bemit l'unicità e la ricercatezza del «fatto a mano».

EXPERTISE The glass, a reminder of local tradition, is used as a reflecting surface diffusing the light softly and uniformly. The gold leaf finish on the glass is hand-done, giving Be Mit the uniqueness and refined elegance typical of a handmade product.







Art 00101 OF_BB



Art 00103 AL_BB



Art 00102 OF_FO



Art 00102 NR_FO



Art 00102 AL_BB



Art 00104 AL_BB



Art 00105 AL_BB

00101

Ceiling / Wall lamp
6 W
980 Lumen
CRI90

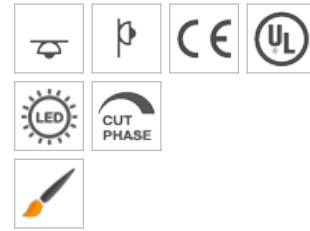
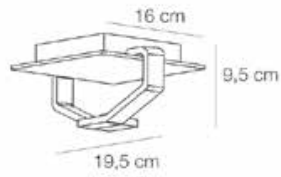

00103

Ceiling / Wall lamp
12 W
1860 Lumen
CRI90

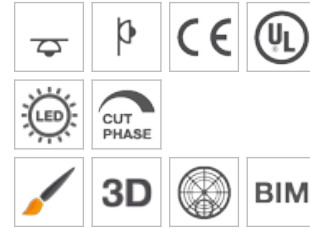
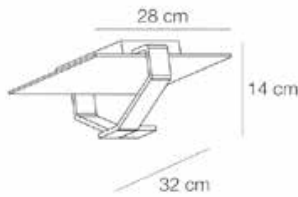

00104

Ceiling / Wall lamp
24,3 W
3480 Lumen
CRI90

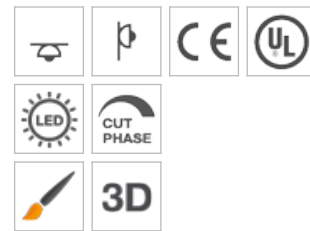
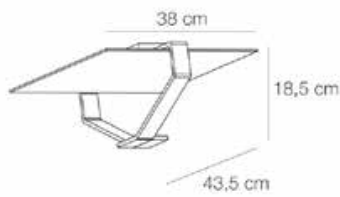

Structure	Dimmer	Led Light	Lens	IP	Diffuser
AL	D (Dimmer)	H 2700 K	X (No lens)	X (IP20)	BB
NR		W 3000 K			FO
OF		N 4000 K			

00102

Ceiling / Wall lamp
12 W
1860 Lumen
CRI90

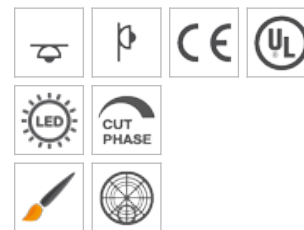

00105

Ceiling lamp
48,6 W
6960 Lumen
CRI90

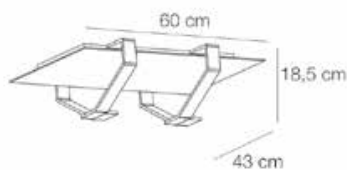

Structure	Dimmer	Led Light	Lens	IP	Diffuser
AL	D (Dimmer)	H 2700 K	X (No lens)	X (IP20)	BB
NR		W 3000 K			FO
OF		N 4000 K			

Rondaj

Designer: Elesi Creative Lab

“L’essenza della luce indiretta.”
“*The essence of indirect light*”



DESIGN Rondaj» è un termine in esperanto che significa «rotondo», una forma semplice che racchiude un’illuminazione a led integrati ad alta efficienza. La lampada da terra illumina con luce riflessa, verso l’alto, e diretta, verso il basso, regolate separatamente da memory touch dimmer posti sul fusto.

DESIGN *Rondaj» is an Esperanto term meaning «round», a simple shape that encloses a high efficiency integrated LED lighting element. The floor lamp version illuminates upwards by reflected light and downwards by direct light, adjusted separately by memory touch dimmers located on the stem.*



PERSONALITÀ La luce diffusa è adatta per esaltare i soffitti e la profondità dello spazio. Attenta al comfort visivo, la lampada da terra è ideale per i momenti di relax.

PERSONALITY *Diffuse light enhances the ceiling and creates spatial depth. The floor lamp is designed with visual comfort in mind, and is ideal for moments of relaxation.*



MAESTRIA La cura nel dettaglio si esprime nelle finiture acciaio e oro francese attraverso la spazzolatura del metallo eseguita completamente a mano. Quell’artigianalità che conferisce unicità a ciascuna lampada.

EXPERTISE *Attention to detail can be seen in the steel and French gold finishes, with the metal brushing done 100% by hand. An artisan touch that makes each lamp unique.*







Art 03602 BB



Art 03603 OF



Art 03605 OF



Art 03605 AC

03602

Ceiling lamp
38 W
5100 Lumen
CRI90

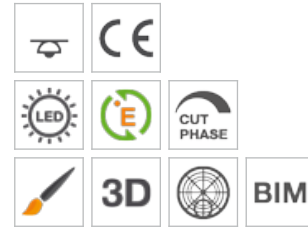
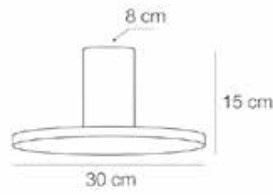

03603



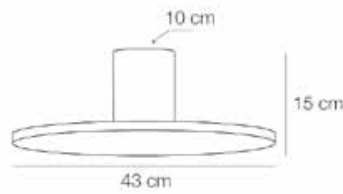



Ceiling lamp
50 W
7000 Lumen
CRI90

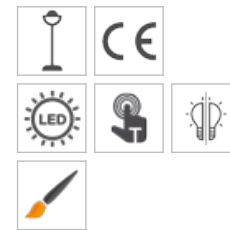
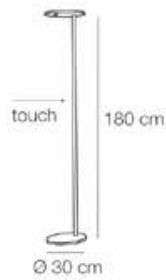

03605

Floor lamp
38 up - 6 down W
5100 up - 880 down Lumen
CRI90



Structure	Dimmer	Led Light	Lens	IP	Diffuser
AC 	D (Dimmer)	H 2700 K 	X (No lens)	X (IP20)	XX
BB 	T (Touch)	W 3000 K 			
OF 		N 4000 K 			

Sotto una nuova Luce

In a new light

Design semplice per una collezione a luce riflessa. Plafoniere e lampade da terra a una luce indiretta per il comfort visivo che ben si adatta a ogni tipo di ambiente.

Round shapes for a collection with reflected light. Ceiling lamp and floor lamp with indirect light for a visual comfort that fits well in any environment.

Storie di trasparenze

Stories of transparencies

*“Più la scrittura è trasparente
e più la poesia è visibile.”*

(Gabriel García Márquez - Scrittore)

*“The more transparent the writing,
the more visible the poetry.”*

(Gabriel García Márquez - Writer)



La trasparenza è la capacità di un corpo di permettere il passaggio, attraverso il suo spessore, di immagini e luce. Questa caratteristica diventa stimolante per ideare oggetti unici. Storie di trasparenze sono delle collezioni nate dalla nostra passione per i materiali e per le forme innovative: lampade che giocano con la luce e diventano protagoniste dello spazio che le ospita.

Transparency is the ability of a body to allow the passage of images and light through it. This characteristic is a stimulus for creating unique objects. Stories of Transparencies are collections born of our passion for materials and innovative forms: lamps that play with the light and become key players in the space they occupy.



Air

Designer: Maurizio Betteto

“Una poesia scritta nell’aria.”
“A poem written in the air.”



DESIGN Ricerca dei materiali e volontà di esaltare la bellezza della luce. E’ questo che ha portato alla creazione di questa collezione di grande effetto e luminosità. Il design ha un’anima di metallo e la struttura in plexiglass (PMMA) con lavorazione di micro-puntinatura che permette una maggiore diffusione della luce.

DESIGN The quest for refined materials and the desire to enhance the beauty of light. These are the two elements underlying this collection which creates an effect of great luminosity. The design has a metal core and Plexiglas (PMMA) structure with stippled pattern for greater light diffusion.



PERSONALITÀ Leggerezza, essenzialità nelle forme e accurato accostamento dei materiali. Una silenziosa presenza che accesa rivela la sua personalità e vivacità. Le due tipologie di luce led (diffusa e direzionale), in combinazione consentono una illuminazione omogenea dello spazio.

PERSONALITY Lightness, simple shapes and careful combination of materials. A silent presence that reveals a lively personality when switched on. The two types of LED light (diffuse and directional) combine to create a uniform lighting effect.



MAESTRIA Per perfezionare la luminosità del materiale PMMA ogni pezzo viene lucidato a mano, mentre il bordo viene satinato per avere lungo il perimetro un effetto morbido di luce.

EXPERTISE To perfect the luminosity of the PMMA material, each piece is hand-polished, and the edge is satin-finished for a soft light effect around the perimeter.







Art 03410 AC





Art 03409 AC

Art 03431 OS



Art 03410 OS



Art 03406 AC



Art 03433 AC



Art 03407 OS

03431

Suspension
6,3 W
800 Lumen
CRI90



03409



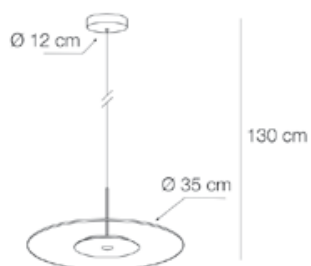



Suspension
12 W
1400 Lumen
CRI90

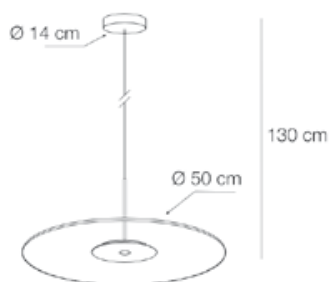

03410

Suspension
20 W
2650 Lumen
CRI90



Structure	Dimmer	Led Light	Lens	IP	Diffuser
AC 	D (Dimmer)	H 2700 K 	X (No lens)	X (IP20)	XX
BB 		W 3000 K 			
OS 		N 4000 K 			

03433

Ceiling lamp
6,3 W
800 Lumen
CRI90

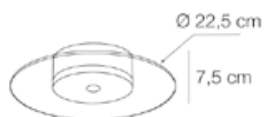

03406

Ceiling lamp
12 W
1400 Lumen
CRI90

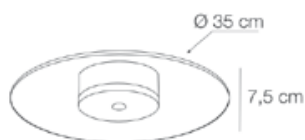

03407

Ceiling lamp
20 W
2650 Lumen
CRI90

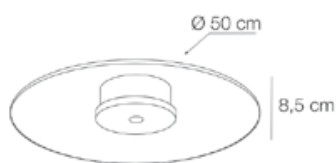

Structure	Dimmer	Led Light	Lens	IP	Diffuser
AC	D (Dimmer)	H 2700 K	X (No lens)	X (IP20)	XX
BB		W 3000 K		P (IP44)	
OS		N 4000 K			



Art 03404 OS

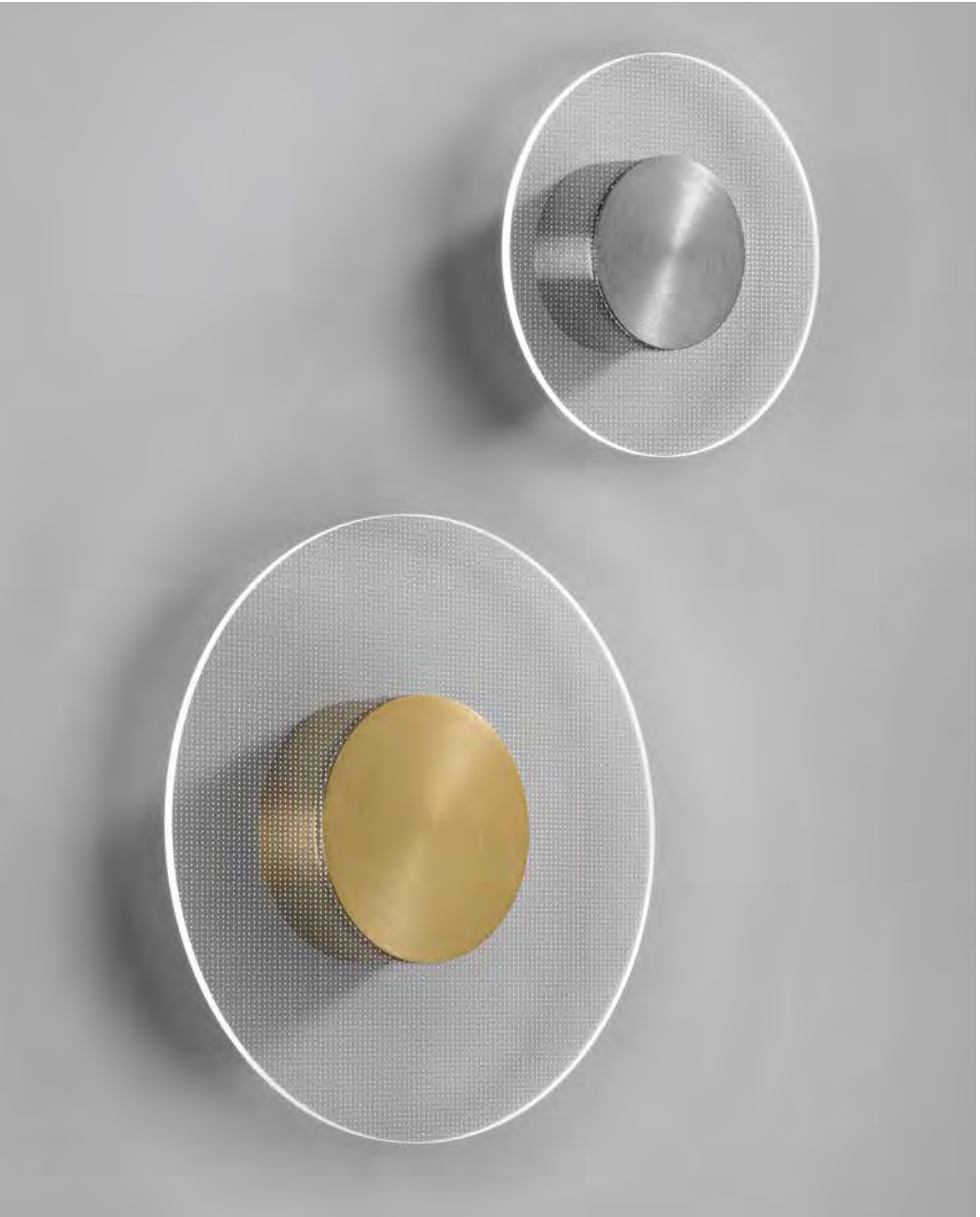

Art 03403 OS / Art 03432 AC



Art 03401 BB

03401

Ceiling / Wall lamp
 2,2 W
 250 Lumen
 CRI90
 No Dimmer

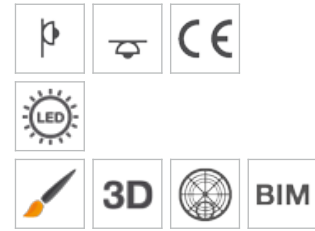

03432

Ceiling / Wall lamp
 3,2 W
 350 Lumen
 CRI90

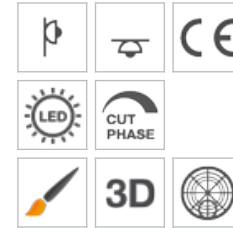

03403

Ceiling / Wall lamp
 5,3 W
 580 Lumen
 CRI90

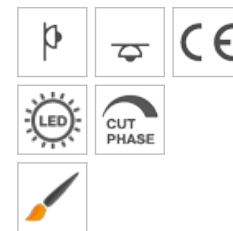

03404

Ceiling / Wall lamp
 7,9 W
 870 Lumen
 CRI90

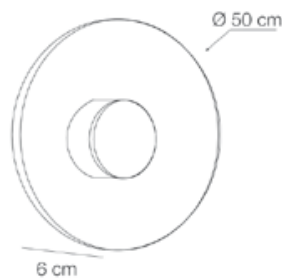

Structure	Dimmer	Led Light	Lens	IP	Diffuser
AC	X (No Dimmer)	H 2700 K	X (No lens)	X (IP20)	XX
BB	D (Dimmer)	W 3000 K			
OS		N 4000 K			

Tour

Designer: Elesi Creative Lab

“La luce che diventa scultura aerea”
“*Light becomes an aerial sculpture*”



DESIGN Elementi a forma circolare che si intersecano sospesi nello spazio: la struttura è in alluminio con diffusore in plexiglass (PMMA) trasparente con lavorazione a micro-puntinatura che permette una migliore diffusione della luce.

DESIGN *Intersecting circular elements suspended in space: the structure is made of aluminium with transparent Plexiglas (PMMA) reflector featuring stippled pattern for greater light diffusion.*



PERSONALITÀ A luce spenta, la sua struttura si integra nell'ambiente diventando scultura aerea. In modalità «on» diventa l' indiscussa protagonista. La luce si fa struttura, evocata da un design minimale e leggero.

PERSONALITY *With the light off, its structure blends into the surroundings, becoming an aerial sculpture. When on, it becomes the undisputed star. The light takes shape, highlighted by a slim minimalist design.*



MAESTRIA Per perfezionare la luminosità del materiale PMMA ogni pezzo viene lucidato a mano, successivamente il bordo viene satinato per avere lungo il perimetro un effetto morbido di luce.

EXPERTISE *To perfect the luminosity of the PMMA material, each piece is hand-polished, and the edge is satin-finished for a soft light effect around the perimeter.*







Art 03735 BB



Art 03734 OL



Art 03735 BB



Art 03733 BB



Art 03732 OL





Art 03731 BB



Art 03703 BB

03731

Suspension
 24 W
 2800 Lumen
 CRI90
 On request: Dali - 0/10V

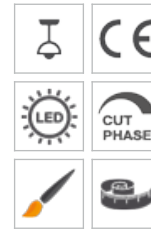

03732

Suspension
 35 W
 3850 Lumen
 CRI90
 On request: Dali - 0/10V

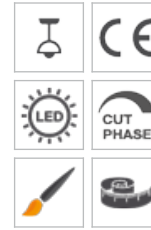

03733

Suspension
 53 W
 5860 Lumen
 CRI90
 On request: Dali - 0/10V

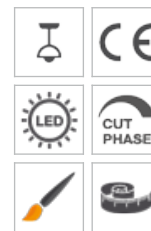

03750

Kit for External Cable
 (Optional)



Structure	Dimmer	Led Light	Lens	IP	Diffuser
BB <input type="checkbox"/>	D (Dimmer)	H 2700 K <input checked="" type="radio"/>	X (No lens)	X (IP20)	XX
OL <input checked="" type="checkbox"/>		W 3000 K <input checked="" type="radio"/>			
		N 4000 K <input type="radio"/>			

03734

Suspension
 24 + 35 W
 2800 + 3580 Lumen
 CRI90
 On request: Dali - 0/10V



03735

Suspension
 35 + 53 W
 3580 + 5860 Lumen
 CRI90
 On request: Dali - 0/10V

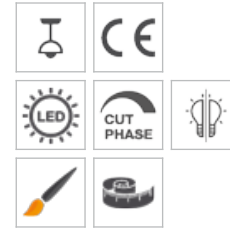

03702

Ceiling lamp
 24 W
 2800 Lumen
 CRI90
 On request: Dali - 0/10V

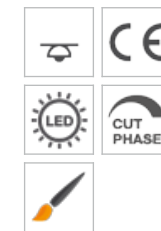
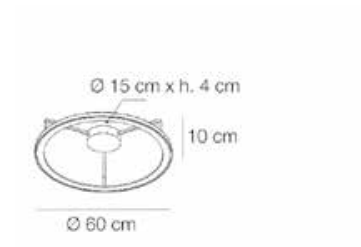

03703

Ceiling lamp
 35 W
 3850 Lumen
 CRI90
 On request: Dali - 0/10V

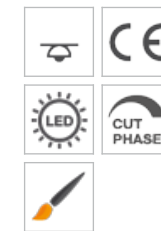
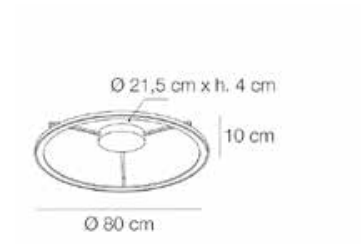

Structure	Dimmer	Led Light	Lens	IP	Diffuser
BB <input type="checkbox"/>	D (Dimmer)	H 2700 K <input checked="" type="radio"/>	X (No lens)	X (IP20)	XX
OL <input checked="" type="checkbox"/>		W 3000 K <input checked="" type="radio"/>			
		N 4000 K <input type="radio"/>			

Versailles

Designer: Architetto Paolo Francia

“L’interpretazione innovativa del classico”
“*Innovative interpretation of a classic*”



DESIGN La collezione è l’interpretazione innovativa del classico, attraverso l’utilizzo di materiali ricercati e forme nuove. L’alluminio si abbina con il plexiglass (PMMA) con lavorazione a micro-puntinatura che permette una migliore diffusione della luce. Tutta la lampada è un’esaltazione di luce, e tutto l’intero braccio diventa sorgente luminosa.

DESIGN The collection is an innovative interpretation of the classic chandelier, using refined materials and new forms. The aluminium combines with the transparent Plexiglas (PMMA) with stippled pattern for greater light diffusion. The whole product is a celebration of light, the arm becomes a light source.



PERSONALITÀ Pur richiamando il concetto classico di lampadario, Versailles è una lampada moderna e innovativa: presente e passato si fondono in un oggetto luminoso che diviene il protagonista dell’ambiente che lo ospita.

PERSONALITY While evoking the classic chandelier, Versailles is a modern innovative light: present and past blend in a luminous object that becomes the focal point of the whole room.



MAESTRIA Traendo ispirazione dai classici lampadari veneziani, in Versailles le braccia si connettono e si innestano rapidamente in fase di installazione per rendere più semplice e sicuro il trasporto e la messa in opera.

EXPERTISE Drawing inspiration from the classic Venetian chandeliers, in Versailles the arms are fitted during installation to facilitate and ensure safe transport.







Art 03506 BB





Art 03506 BB



Art 03505 BB



Art 03502 BB

03505

Chandelier 5 Arms
57,6 + 6 W
6300 + 880 Lumen
CRI90

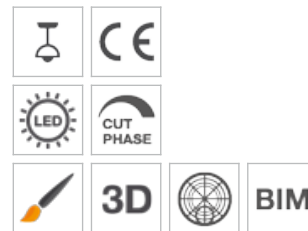
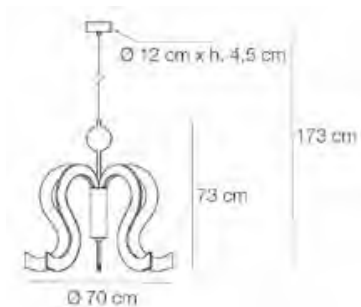

03506

Chandelier 8 Arms
92 + 6 W
10000 + 880 Lumen
CRI90

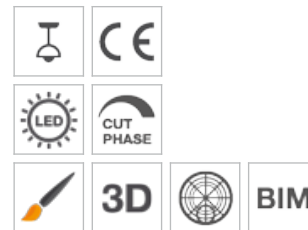
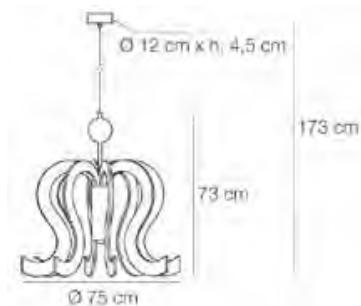

03502

Wall Lamp 3 Arms
17 + 3 W
1800 + 450 Lumen
CRI90
No Dimmer

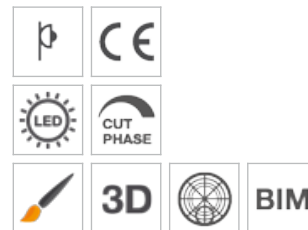
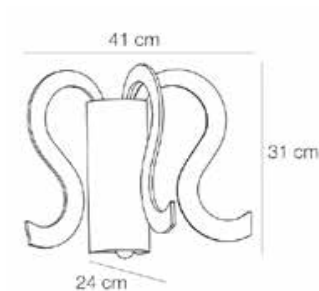

Structure	Dimmer	Led Light	Lens	IP	Diffuser
BB <input type="checkbox"/>	X (No Dimmer) D (Dimmer)	H 2700 K W 3000 K N 4000 K	X (No lens)	X (IP20)	XX

Storie di alchimie

“La cosa più bella che possiamo sperimentare è il mistero; è la fonte di ogni vera arte e di ogni vera scienza”

(Albert Einstein - fisico)

Stories of alchemy

“The most beautiful thing we can experience is the mysterious. It is the source of all true art and science.”

(Albert Einstein - physicist)



Il vetro è alchimia, una fusione simultanea dei 4 elementi: il vetro è trasparente come l'aria, fluido come l'acqua, caldo come il fuoco che lo fonde e, alla fine, duro come la terra in cui nasce. Storie di Alchimie sono collezioni che raccontano di questo materiale ricco, vivo e nobile, caratteristico del nostro territorio. Protagonista, assieme alla luce, delle lampade di queste collezioni.

Glass is alchemy, a simultaneous fusion of the 4 elements: glass is transparent like air, fluid like water, hot like the fire that melts it and, in the end, hard like the earth from where it originates. Stories of Alchemies are collections that illustrate this rich, living noble material, which is also a centuries-old local tradition. Together with light, glass is the key feature of the lamps in these collections.



Pois

Designer: Elesi Creative Lab

“Parabole di grande magnetismo” “Magnetic appeal”



DESIGN Nella collezione Pois il design sobrio delle forme e l'innovazione tecnologica si uniscono in un risultato vincente: un'unica lastra di vetro piano con abbassamenti eseguiti a caldo e un sistema di fissaggio magnetico, veloce, semplice e senza viti a vista.

DESIGN In the Pois collection, simple shapes and technological innovation combine for a winning result: one single sheet of flat glass, with hot-pressed indentations, and a simple quick magnetic fastening system, with no visible screws.



PERSONALITÀ La forma geometrica della lampada è addolcita dai bassorilievi eseguiti in fusione a caldo del vetro. Essenziale, ma accattivante, possiede forte personalità grazie a questi dettagli che la rendono unica.

PERSONALITY The geometric shape of the light is softened by the hot-pressed indentations of the glass. Simple but eye-catching, it has a strong personality thanks to these details that make it unique.



MAESTRIA Il vetro, che rimanda alla tradizione del territorio, può essere decorato in foglia oro, lavorazione artigianale che dona a Pois l'unicità e la ricercatezza del «fatto a mano».

EXPERTISE The glass, a reminder of local tradition, can be decorated in gold leaf, an artisan technique that gives Pois the uniqueness and refined elegance of a handmade product.





Nel 2019 POIS è stata insignita del VSL Award con le seguenti motivazioni: la lampada unisce la tradizione della lavorazione del vetro e una funzionalità non gratuita di linee stilizzate e pure.

Leggerezza ed equilibrio declinati in un materiale prezioso, con parabole di grande magnetismo e armonia.

In 2019 POIS received the VSL Award for the following reasons: the light combines glass working tradition with the wholly appropriate functionality of pure stylized lines.

Lightness and equilibrium expressed in a precious material, with effects of great magnetism and harmony.



Art 02001 BB



Art 02002 NR

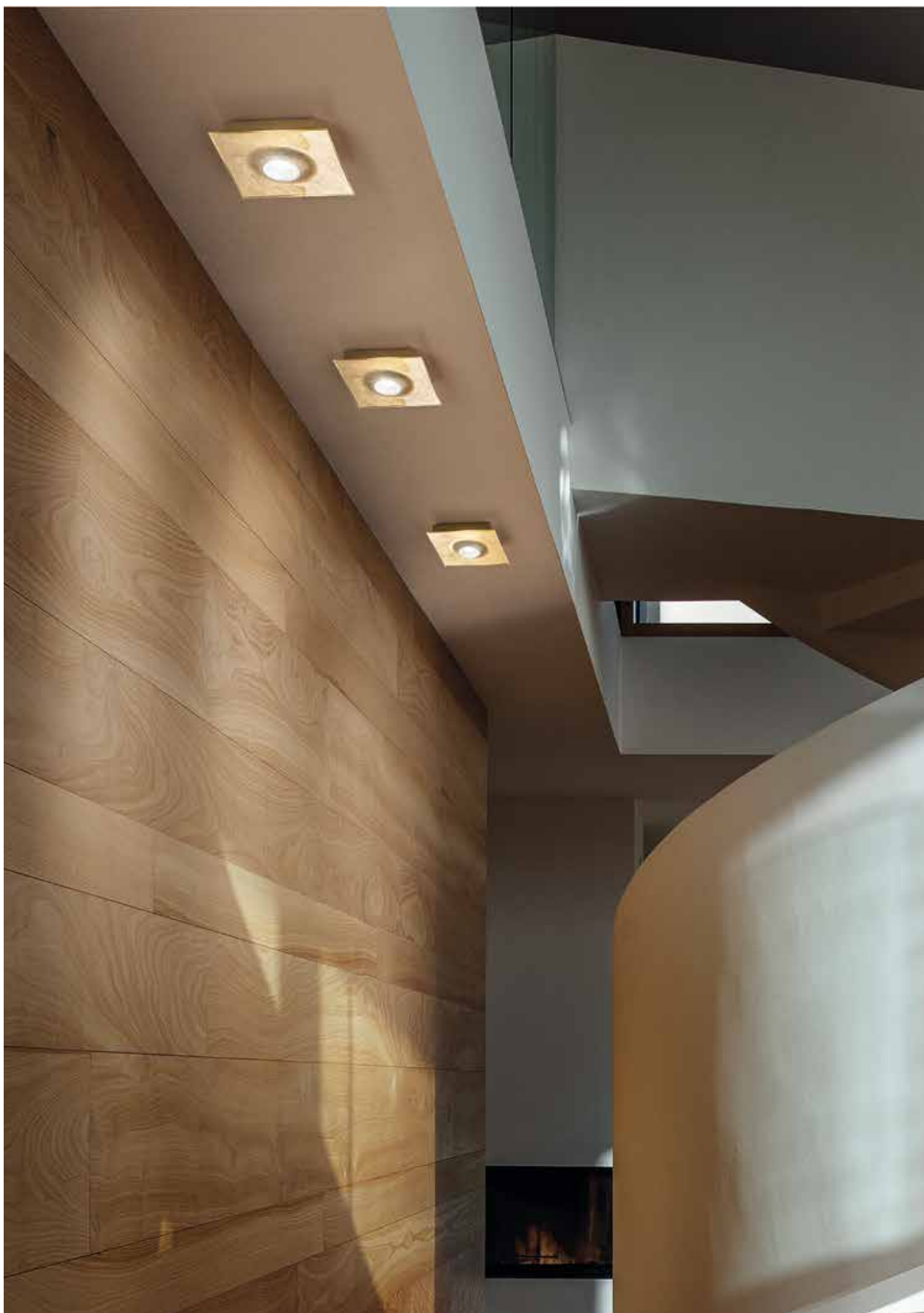

Art 02001 FO



Art 02003 FA



Art 02005 FO



Art 02007 NR



Art 02008 BB



Art 02004 BB



Art 02006 NR

02001

Ceiling lamp
6,5 W
770 Lumen
CRI90

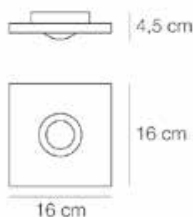

02002

Ceiling lamp
12,9 W
1540 Lumen
CRI90

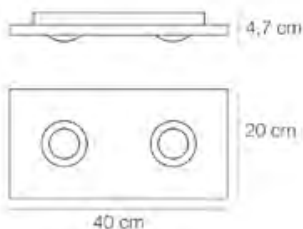

02003

Ceiling lamp
19,5 W
2310 Lumen
CRI90

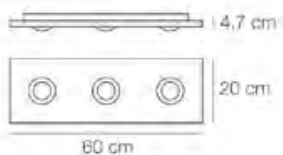

02005

Ceiling lamp
25,8 W
3080 Lumen
CRI90

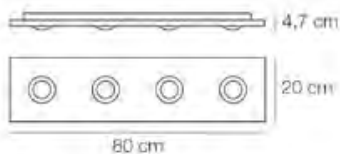

Structure	Dimmer	Led Light	Lens	IP	Diffuser
XX	D (Dimmer)	H 2700 K ● W 3000 K ● N 4000 K ○	X (No lens)	X (IP20) P (IP44)	BB <input type="checkbox"/> FA <input type="checkbox"/> FO <input type="checkbox"/> NR <input type="checkbox"/>

02007

Ceiling lamp
37,8 W
4620 Lumen
CRI90

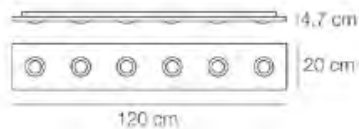

02004

Ceiling lamp
25,8 W
3080 Lumen
CRI90

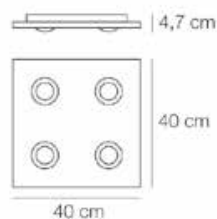

02006

Ceiling lamp
37,8 W
4620 Lumen
CRI90

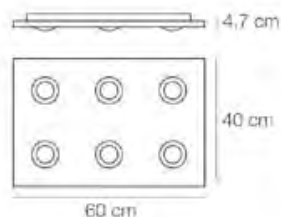

02008

Recessed lamp
6,5 W
770 Lumen
CRI90

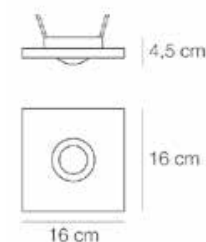

Structure	Dimmer	Led Light	Lens	IP	Diffuser
XX	D (Dimmer)	H 2700 K W 3000 K N 4000 K	X (No lens)	X (IP20) P (IP44)	BB FA FO NR



Art 02011 AC_BB



Art 02011 AC_NR



Art 02009 AC_FA

02009



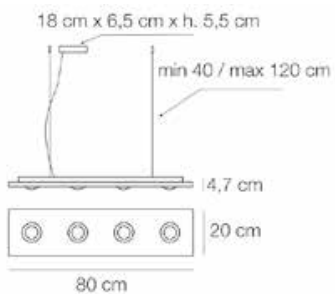



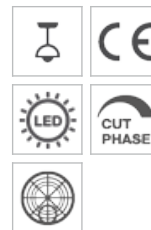
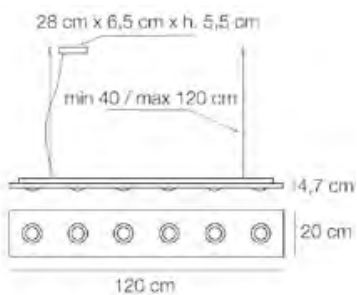

Suspension
25,8 W
3080 Lumen
CRI90



02011

Suspension
38,7 W
4620 Lumen
CRI90



Structure	Dimmer	Led Light	Lens	IP	Diffuser
AC  OF 	D (Dimmer)	H 2700 K  W 3000 K  N 4000 K 	X (No lens)	X (IP20)	BB  FA  FO  NR 

Mir

Designer: Elesi Creative Lab

“Vetro, territorio e arte” “Glass, local traditions and art”



DESIGN Nella collezione Mir il design sobrio delle forme e l'innovazione tecnologica si uniscono in un risultato vincente: un'unica lastra di vetro piano con abbassamenti eseguiti a caldo e un sistema di fissaggio magnetico, veloce, semplice e senza viti a vista.

DESIGN In the Mir collection, simple shapes and technological innovation combine for a winning result: one single sheet of flat glass, with hot-pressed indentations, and a simple quick magnetic fastening system, with no visible screws.



PERSONALITÀ La forma geometrica della lampada è addolcita dai bassorilievi eseguiti in fusione a caldo del vetro. Essenziale, ma accattivante, possiede forte personalità grazie a questi dettagli che la rendono unica.

PERSONALITY The geometric shape of the light is softened by the hot-pressed indentations of the glass. Simple but eye-catching, it has a strong personality thanks to these details that make it unique.



MAESTRIA Il vetro, che rimanda alla tradizione del territorio, può essere decorato in foglia oro, lavorazione artigianale che dona a Mir l'unicità e la ricercatezza del «fatto a mano».

EXPERTISE The glass, a reminder of local tradition, can be decorated in gold leaf, an artisan technique that gives Mir the uniqueness and refined elegance of a handmade product.







Art 00703 FO



Art 00703 FO



Art 00702 BB



Art 00702 BB



Art 00705 FO



Art 00701 FA

00701

Ceiling lamp
6,5 W
770 Lumen
CRI90



00702

Ceiling lamp
19,5 W
2310 Lumen
CRI90

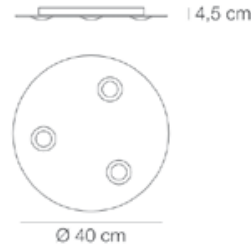

00703

Ceiling lamp
37,8 W
4620 Lumen
CRI90

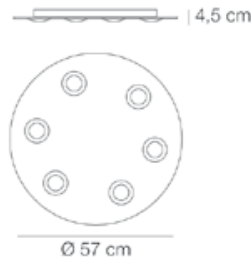

00705

Recessed lamp
6,5 W
770 Lumen
CRI90

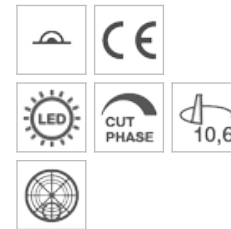

Structure	Dimmer	Led Light	Lens	IP	Diffuser
XX	D (Dimmer)	H 2700 K W 3000 K N 4000 K	X (No lens)	X (IP20) P (IP44)	BB FO FA

Aura

Designer: Elesi Creative Lab

“Linee di luce che disegnano il vetro”
“Glass designed by lines of light”



DESIGN Nella collezione Aura la bellezza del vetro si esalta nei colori e nella materia utilizzata. Il vetro è ricavato da una unica lastra e il suo design rimane integro, senza fori o tagli. L'effetto delle linee è dato dall'accostamento di lavorazioni diverse sul vetro.

DESIGN In the Aura collection the beauty of the glass is enhanced by the colours and material used. The glass is obtained from one single sheet, without holes or cuts. The effect of the lines is created by the combined use of different work techniques on the glass.



PERSONALITÀ Il vetro colorato è interrotto da linee satiniate che permettono il passaggio della luce e diventano elementi distintivi. Temperamento magnetico: Il diffusore in vetro è fissato con un sistema a calamite che consente una installazione rapida e agevole.

PERSONALITY The coloured glass is interrupted by satin-finish lines that allow passage of the light and become distinctive elements. Magnetic temperament: the glass reflector is fixed by a magnet system which allows quick easy installation.



MAESTRIA L'unicità è nel vetro che racchiude diverse lavorazioni artigianali: le decorazioni del vetro sono eseguite a mano da abili artigiani del territorio donando ad Aura l'unicità e la ricercatezza del «fatto a mano».

EXPERTISE The unique element of this lighting product is the glass which features different artisan techniques: the glass decorations are hand-done by skilled local craftsmen, giving Aura the uniqueness and refined elegance of a handmade product.







Art 02904 NR



Art 02905 BB

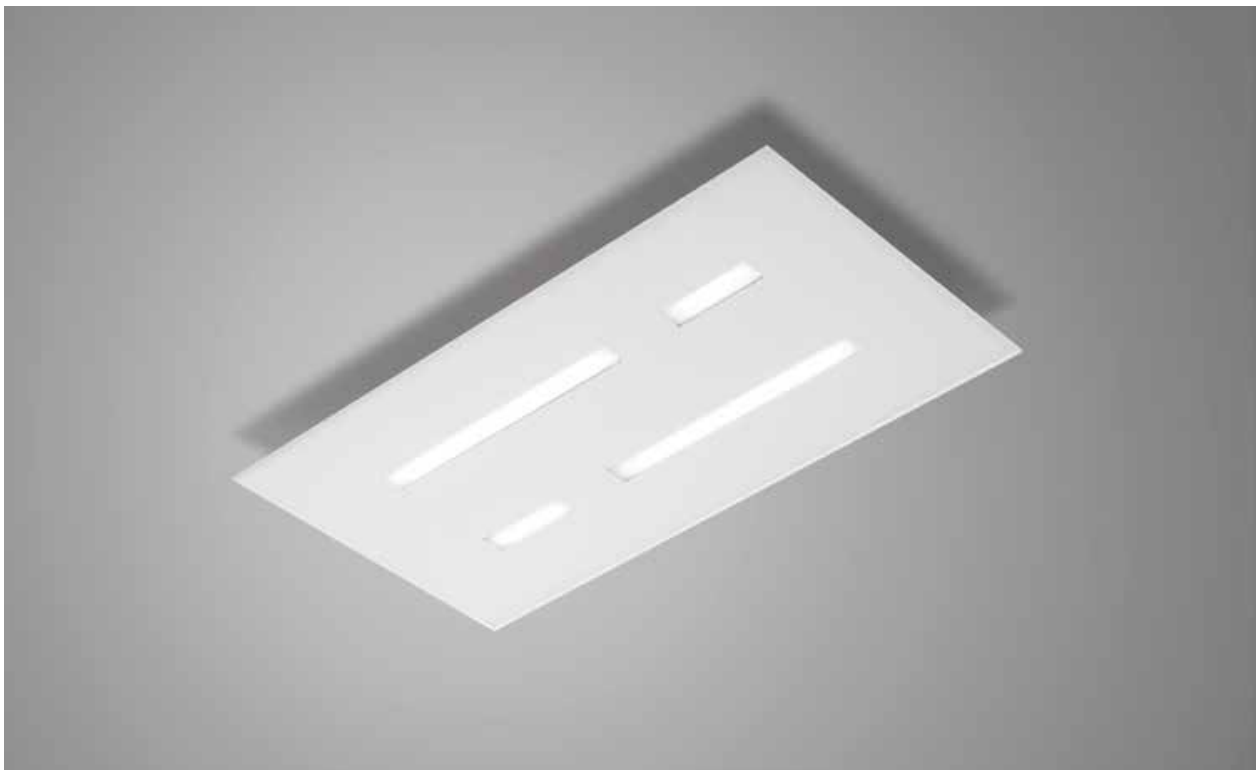

Art 02902 BB



Art 02903 FA



Art 02901 NR



Art 02907 FO

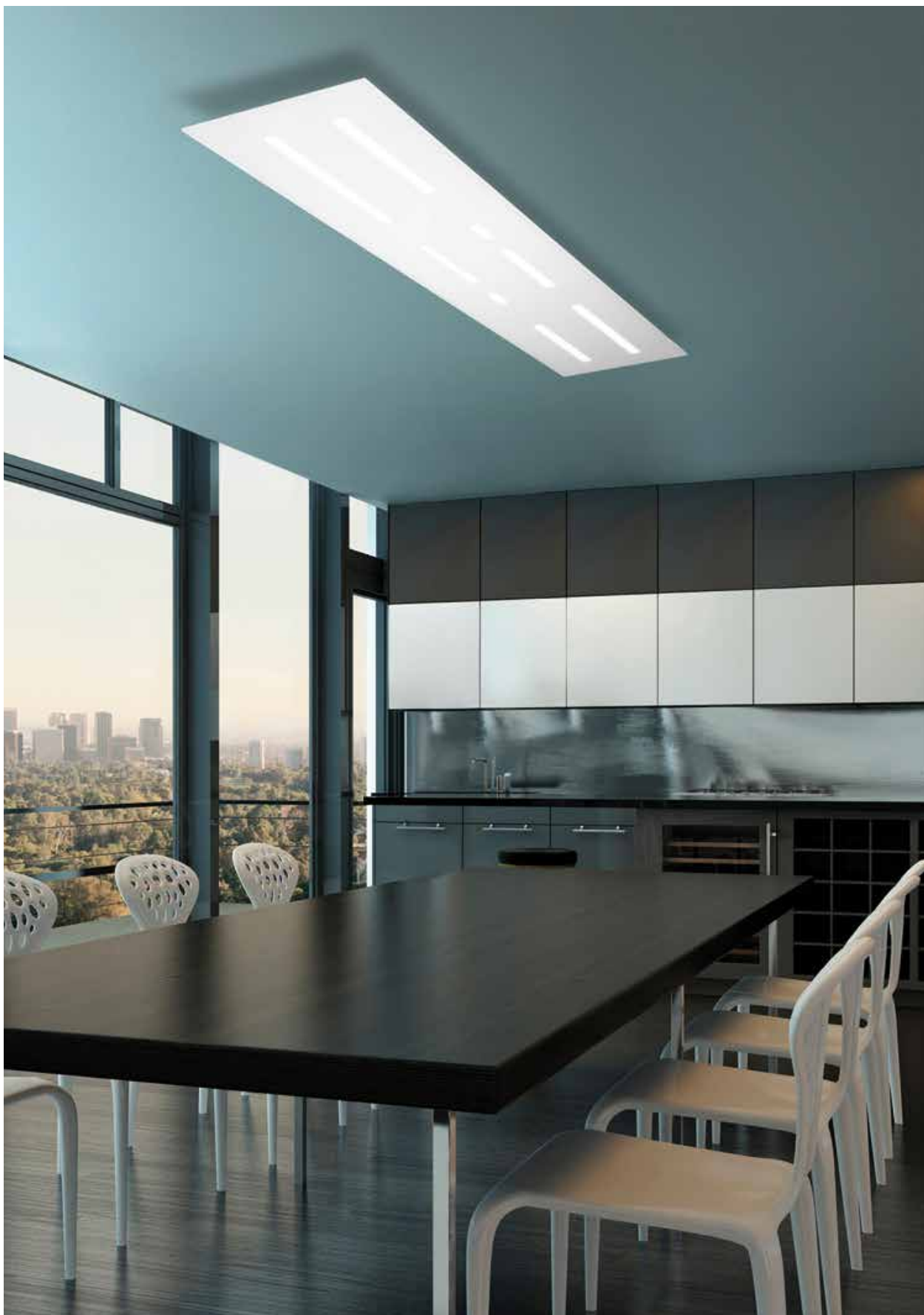

Art 02908 BB

02902

Ceiling lamp
13,5 W
1900 Lumen
CRI90
On request: Dali - 0/10V

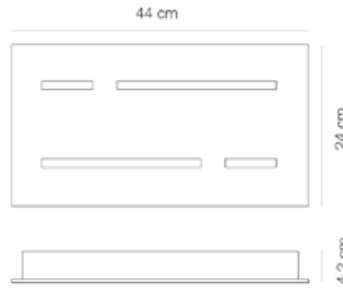

02903

Ceiling lamp
19,2 W
2650 Lumen
CRI90
On request: Dali - 0/10V

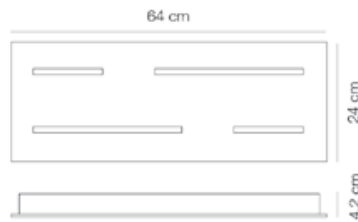

02907

Ceiling lamp
30,9 W
4300 Lumen
CRI90
On request: Dali - 0/10V

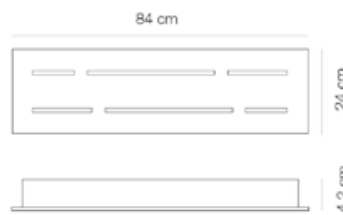

02908

Ceiling lamp
44,5 W
6200 Lumen
CRI90
On request: Dali - 0/10V

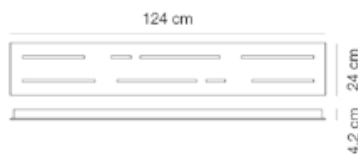

Structure	Dimmer	Led Light	Lens	IP	Diffuser
XX	D (Dimmer)	H 2700 K ● W 3000 K ● N 4000 K ○	X (No lens)	X (IP20) P (IP44)	BB <input type="checkbox"/> FA <input type="checkbox"/> FO <input type="checkbox"/> NR <input type="checkbox"/>

02901

Ceiling / Wall lamp
 6,9 W
 970 Lumen
 CRI90
 On request: Dali - 0/10V

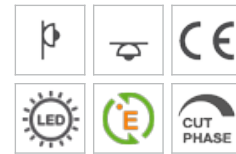

02904

Ceiling lamp
 23,7 W
 3300 Lumen
 CRI90
 On request: Dali - 0/10V



02905

Ceiling lamp
 44,5 W
 6200 Lumen
 CRI90
 On request: Dali - 0/10V

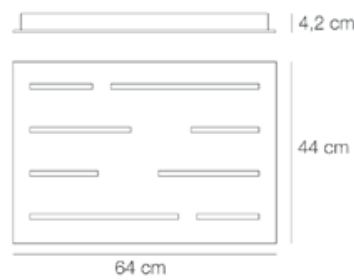

Structure	Dimmer	Led Light	Lens	IP	Diffuser
XX	D (Dimmer)	H 2700 K W 3000 K N 4000 K	X (No lens)	X (IP20) P (IP44)	BB FA FO NR

Storie di accenti

*“La Luce deve cadere
come un sasso.”*

(Josef Svoboda- Scenografo)

Stories of accents

*“Light must drop
like a stone.”*

(Josef Svoboda - Stage designer)



Così come nella scrittura l'Accento è un rafforzamento o elevazione del tono con cui si dà a una sillaba maggior rilievo rispetto ad altre della stessa parola, così in illuminotecnica la luce d'accento serve per far risaltare un particolare, un oggetto, un elemento nello spazio. Storie di Accenti raccontano di lampade spot che trasformano la luce in volume creando dei coni luminosi che mettono in evidenza gli oggetti sui quali si posano.

In writing, an accent intensifies or highlights the tone, giving a syllable greater emphasis than others in the same word; in the same way, in lighting an accent light serves to bring out a detail, an object or an element in space. Stories of Accents describe spotlights that transform the light into volume, creating bright cones of light that focus on specific objects.



Piston

Designer: Elesi Creative Lab

“Evidenzia lo spazio che ami”
“*Highlight the space you love*”



DESIGN Il nome evocativo in meccanica è stato attribuito per le prestazioni illuminotecniche della lampada. Una Collezione di spot orientabili da soffitto e parete che permettono di direzionare la luce esattamente dove serve. A questo scopo ciascuna lampada è dotata di snodo che consente la rotazione a 360° e il movimento a 90°.

DESIGN *The name refers not only due to the shape of this light but also to its lighting performance. A collection of adjustable ceiling and wall spotlights that allow you to direct the light exactly where needed. For this purpose, each light is provided with a joint for 360° rotation and 90° movement.*



PERSONALITÀ Piston trasforma la luce in volume creando dei coni luminosi che mettono in evidenza gli oggetti sui quali si posano. La luce taglia gli spazi seguendo la direzione dello spot in un gioco di volumi in chiaro scuro.

PERSONALITY *Piston transforms light into volume, creating cones of light to highlight individual objects. The light cuts through space following the direction of the spot in a play of chiaroscuro volumes.*



MAESTRIA La cura nel dettaglio esprime nelle finiture acciaio e oro francese attraverso la spazzolatura del metallo eseguita completamente a mano. Quell'artigianalità che conferisce unicità a ciascuna lampada.

EXPERTISE *Attention to detail can be seen in the steel and French gold finishes, with the metal brushing done 100% by hand. Craftsmanship that makes each product unique.*







Art 04901 AC



Art 04902 OF



Art 04903 AC



Art 04904 NR Ceiling Lamp



Art 04904 NR Wall Lamp

04901

Ceiling/Wall lamp
6 W
880 Lumen
CRI90

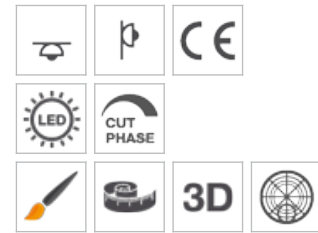
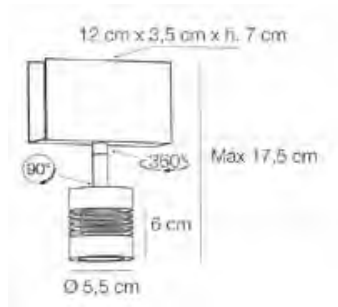

04902

Ceiling/ Wall lamp
2x6 W
2x880 Lumen
CRI90

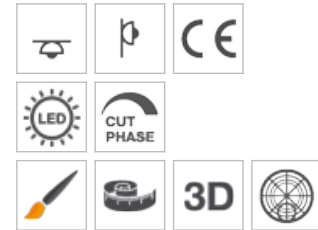
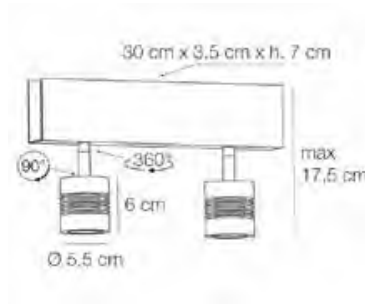

04903

Ceiling / Wall lamp
3x6 W
3x880 Lumen
CRI90

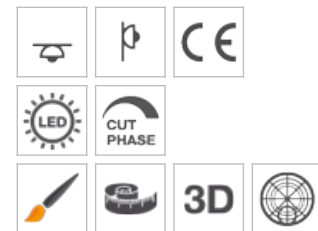
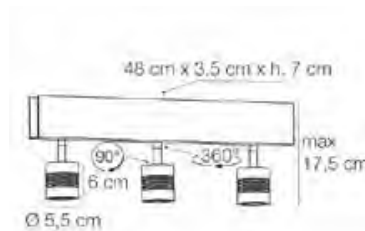

04904

Ceiling/ Wall lamp
6 W
880 Lumen
CRI90

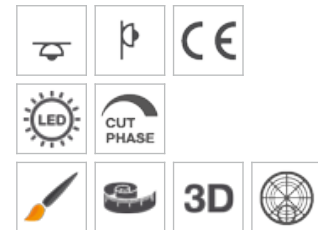

Structure	Dimmer	Led Light	Lens	IP	Diffuser
AC	D (Dimmer)	H 2700 K	2 (25°)	X (IP20)	XX
NR		W 3000 K	4 (45°)	P (IP44)	
OF		N 4000 K			



Art 04912 OF

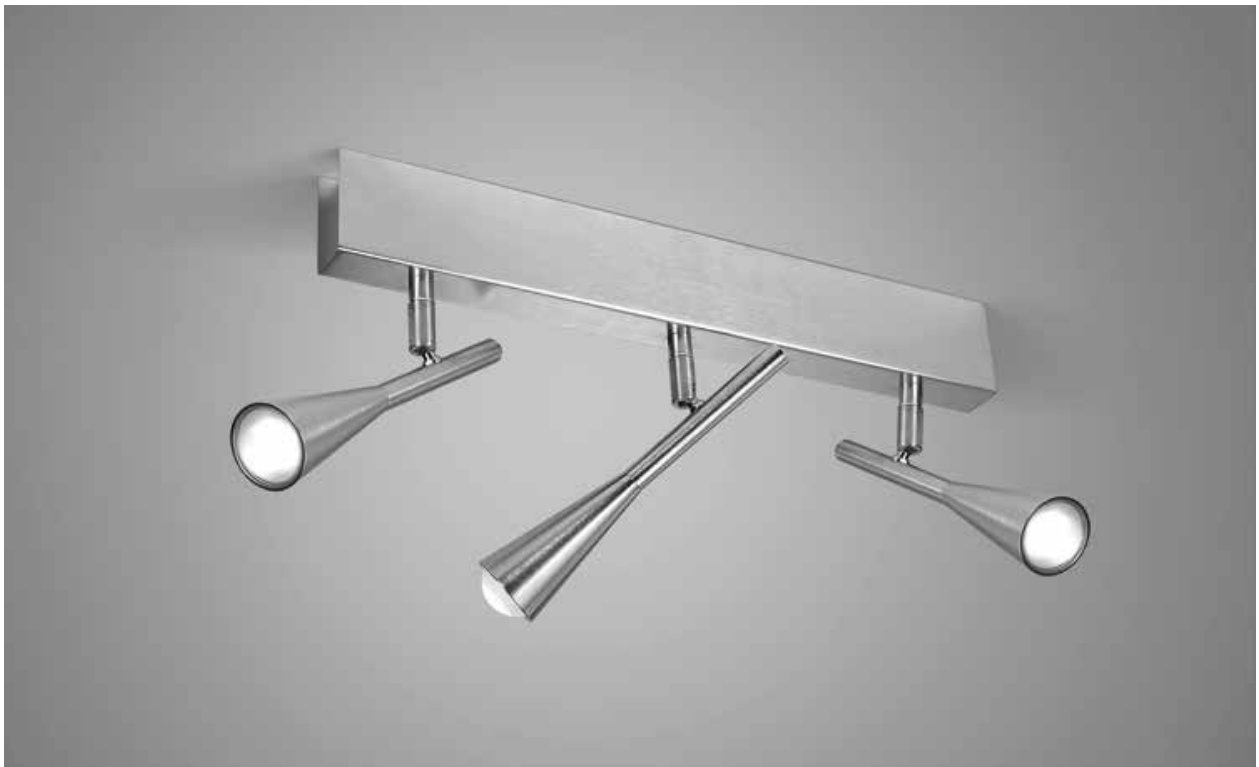

Art 04913 AC

04911

Ceiling / Wall lamp
6,7 W
900 Lumen
CRI90

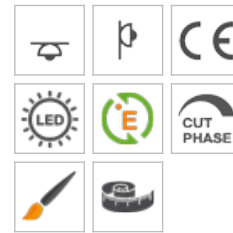
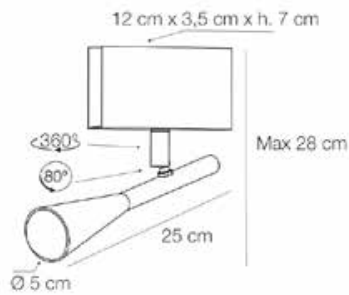

04912

Ceiling / Wall lamp
2x6,7 W
2x900 Lumen
CRI90

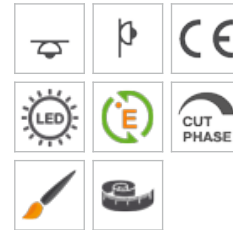
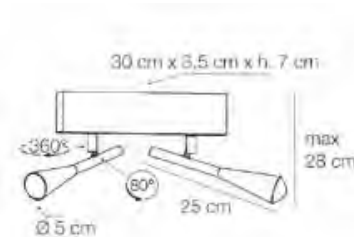

04913

Ceiling / Wall lamp
3x6,7 W
3x900 Lumen
CRI90

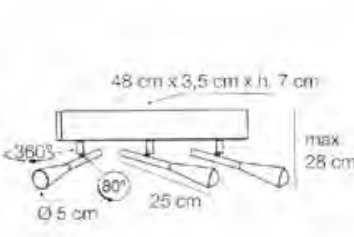

Structure	Dimmer	Led Light	Lens	IP	Diffuser
AC	D (Dimmer)	H 2700 K	X (No lens)	X (IP20)	XX
NR		W 3000 K			
OF		N 4000 K			

Techno

Designer: Elesi Creative Lab

“Versatilità e confort visivo”
“Versatility and visual comfort”



DESIGN Una Collezione di spot orientabili che permettono di direzionare la luce esattamente dove serve. A questo scopo ciascuna lampada è dotata di snodo che consente la rotazione a 360° e il movimento a 90° o di tubo flessibile.

DESIGN A collection of adjustable spotlights that allow you to direct the light exactly where needed. For this purpose, each lamp is provided with a joint for 360° rotation and 90° movement, or with a flexible tube.



PERSONALITÀ Per le sue caratteristiche è ottimale come luce d'accento, per illuminare dettagli ed oggetti. Come lampada da lettura mette in luce lo spazio desiderato, creando in giusto confort visivo.

PERSONALITY Ideal for accent lighting, to light details and objects. As a reading light, it highlights the desired area, ensuring visual comfort.



MAESTRIA La cura nel dettaglio si esprime nelle finiture in acciaio e oro francese che attraverso la spazzolatura del metallo, eseguita completamente a mano conferisce alla lampada l'artigianalità che la rende unica.

EXPERTISE Attention to detail can be seen in the steel and French gold finishes, with the metal brushing done 100% by hand. Craftsmanship that makes each product unique.







Art 04802 OF



Art 04803 OF



Art 04801 OF



Art 04804 NR



Art 04805 AC

04801

Wall lamp
3 W
370 Lumen
CRI90

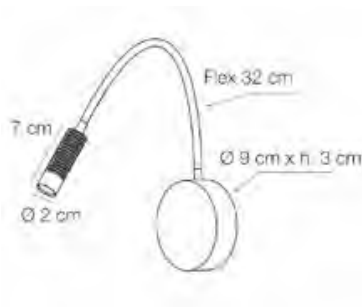

04802

Wall lamp
3 W
370 Lumen
CRI90
Cable + Switch on/off



04803





Wall lamp
3 W
370 Lumen
CRI90
Switch on/off

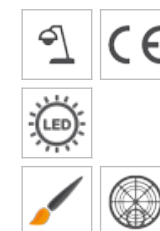

04804

Table lamp
3 W
370 Lumen
CRI90







Structure	Dimmer	Led Light	Lens	IP	Diffuser
AC  NR  OF 	X (No Dimmer)	W 3000 K  N 4000 K 	2 (25°)	X (IP20)	XX

04805

Wall lamp
3 W
370 Lumen
CRI90



Structure	Dimmer	Led Light	Lens	IP	Diffuser
AC  NR  OF 	X (No Dimmer)	W 3000 K  N 4000 K 	2 (25°)	X (IP20)	XX

Doc

Designer: Elesi Creative Lab

“Funzionalità e praticità” “Functionality and practicality”



DESIGN Progettata come lampada da lettura, studio e lavoro consente di orientare la luce secondo le proprie necessità, regolando l'intensità con memory touch dimmer. Dotata di 3 snodi, mette in luce lo spazio desiderato creando il giusto comfort visivo.

DESIGN Designed as a light for reading, studying and working, it allows you to direct the light as required, adjusting the intensity by memory touch dimmer. Provided with 3 joints, it highlights the desired area, ensuring visual comfort.



PERSONALITÀ Stabile, maneggevole, funzionale. Doc è semplicemente pratica, una lampada che offre una soluzione rapida per illuminare il piano di lavoro, la scrivania, l'angolo relax.

PERSONALITY Stable, handy, functional. Doc is simply practical, a lamp that offers a quick solution for lighting the work top, the desk and the relaxation corner.



MAESTRIA La cura nel dettaglio trova la massima espressione nella spazzolatura del metallo, lavorazione di finitura eseguita completamente a mano. Quell'artigianalità che conferisce unicità a ciascuna lampada.

EXPERTISE Attention to detail reaches a high point in the metal brushing, a finishing process carried out 100% by hand. Craftsmanship that makes each product unique.







Art 05101 AS / Art 05101 OS / Art 05101 BB



Art 05101 NR



Art 05102 AS



Art 05103 OS



Art 05103 NR

05101

Table lamp
6,5 W
780 Lumen
CRI90

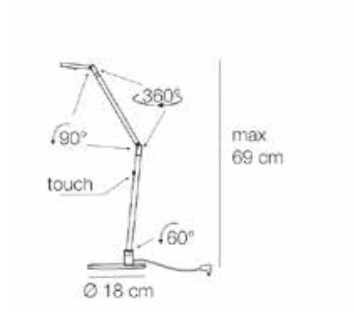

05102

Floor lamp
6,8 W
780 Lumen
CRI90



05103

Table lamp
6 W
900 Lumen
CRI90

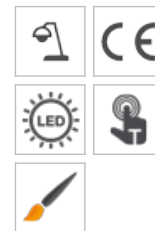

Structure	Dimmer	Led Light	Lens	IP	Diffuser
AS	T (Touch)	H 2700 K	X (No lens)	X (IP20)	XX
BB		W 3000 K			
NR		N 4000 K			
OS					

Storie di geometrie

Stories of geometries

“La linea geometrica è un ente invisibile, essa è la traccia lasciata dal punto in movimento.”

(Wassily Kandiskij - Pittore)

“The geometric line is an invisible entity, it is the trace left by the point in movement.”

(Wassily Kandinsky - Painter)



La geometria costituisce uno degli strumenti più importanti per controllare lo spazio e fornire la regola per tracciare e connettere i diversi elementi attraverso i quali si costruisce la realtà architettonica. Le collezioni di Storie di Geometrie raccontano di lampade definite da forme semplici, che si inseriscono negli ambienti in modo funzionale e discreto illuminando gli spazi con equilibrio ed eleganza.

Geometry is one of the most important tools for controlling space and providing rules for tracing and connecting the different elements used in the construction of architectural reality. The collections of Stories of Geometries describe lamps defined by simple forms, which blend in with their surroundings functionally and discreetly, providing balanced elegant lighting.



Klaro

Designer: Mauro Gennari

“Combinazioni di luci” “Light combinations”



DESIGN Klaro propone un'idea nuova di lampada, con una combinazione di luci che possono funzionare sia insieme, sia separatamente. La luce data dalle lampadine GX53 illumina l'ambiente, la strip led illumina il vetro e crea un'atmosfera di luce riflessa diventando luce di cortesia. L'accensione separata può avvenire tramite un dispositivo di selezione (disponibile a parte).



PERSONALITÀ Lampada funzionale. La doppia emissione luminosa favorisce la doppia funzione, da una parte illuminazione diretta della stanza, dall'altra come luce di servizio per illuminare corridoi, scale, camere da letto o stanze per il tempo libero.



MAESTRIA La molatura è una lavorazione artigianale antica, che viene eseguita oggi come un tempo da mani abili e sapienti donando al vetro una dinamica lucentezza.

DESIGN Klaro proposes a new lighting idea, with a combination of lights that can operate both together and separately. The light emitted by the GX53 bulbs lights the room, while the LED strip illuminates the glass and creates an atmosphere of reflected light, becoming a courtesy light. The separate switch-on function can be obtained by means of a selection device (available separately).

PERSONALITY Functional light. The twin light emission offers a dual function: on the one hand direct lighting of the rooms, and on the other a service light for corridors, stairs, bedrooms or play/hobby rooms.

EXPERTISE Grinding is an ancient craft, which is carried out today just as in the past by expert skilled hands, giving the glass a bright lively finish.







Art 04008 AC_W_TR



Art 04008 AC_W_TR

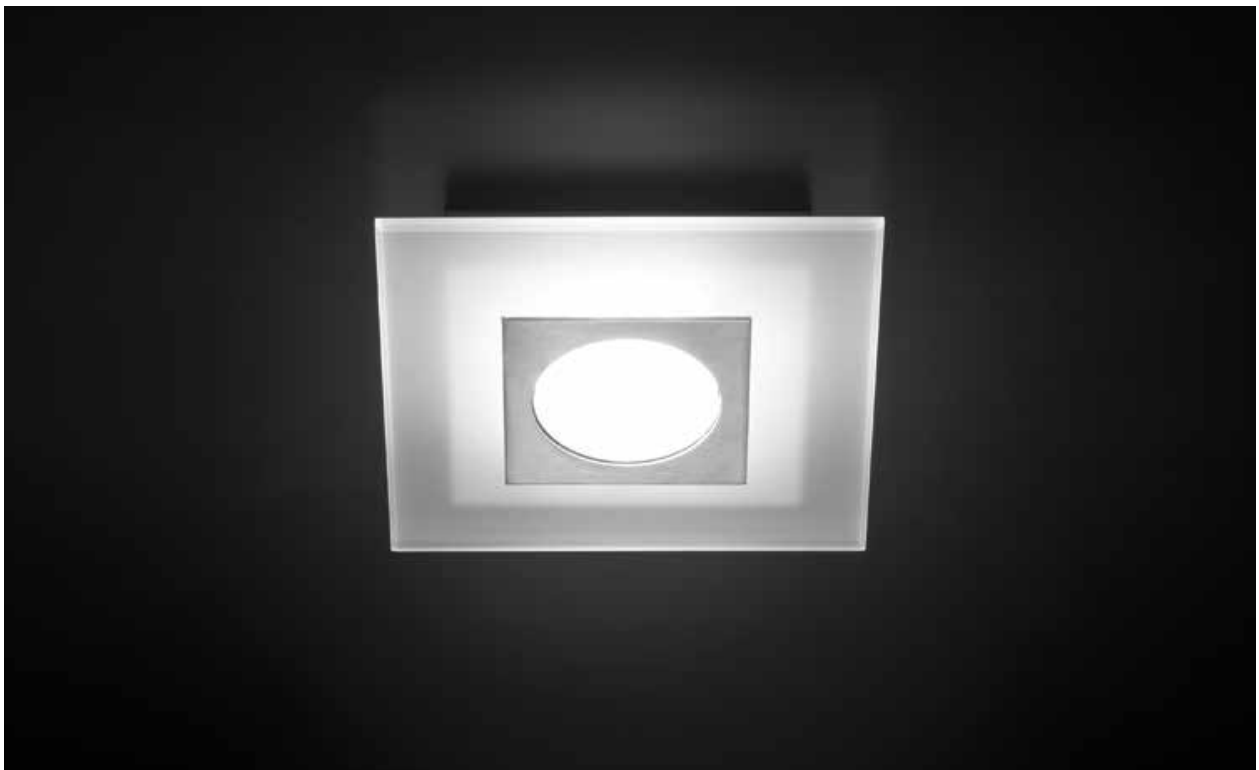

Art 04001 AC_W_ST

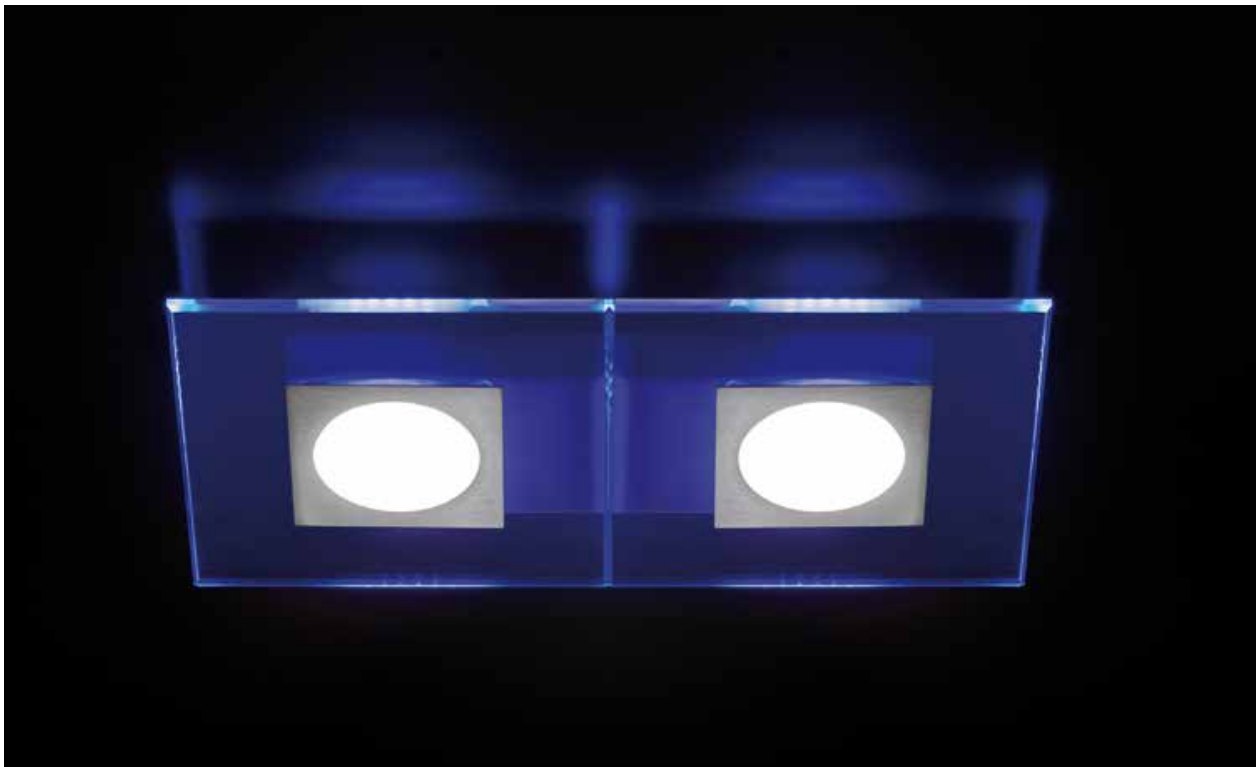

Art 04002 AC_B_TR



Art 04002 BB_B_TR / Art 04011AC_B_TR



Art 04005 AC_W_ST



Art 04004 AC_B_TR

04001

Ceiling lamp
GX53 1x7W + LED 1,2 W
Lampadina non inclusa
Bulb not included

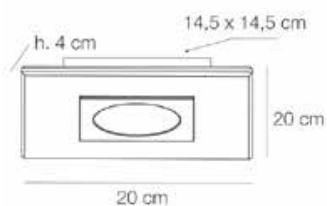

04002



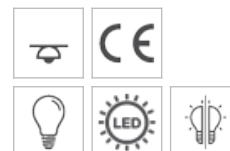
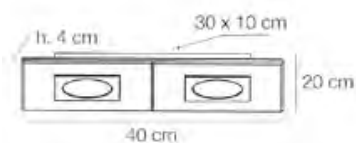



Ceiling lamp
GX53 2x7W + LED 2,4 W
Lampadina non inclusa
Bulb not included

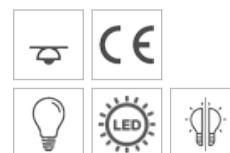
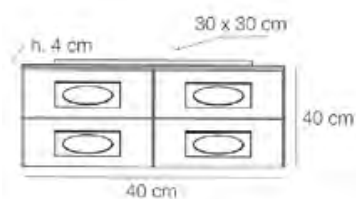

04004

Ceiling lamp
GX53 4x7W + LED 4,8 W
Lampadina non inclusa
Bulb not included



Structure	Dimmer	Led Light	Lens	IP	Diffuser
AC  BB 	X (No Dimmer)	B  W 3000 K 	X (No lens)	X (IP20)	ST  TR 

04005

Ceiling lamp
 GX53 5x7W + LED 6 W
 Lampadina non inclusa
 Bulb not included

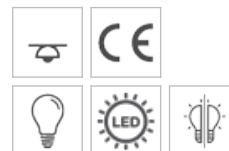
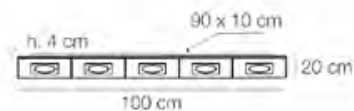

04008



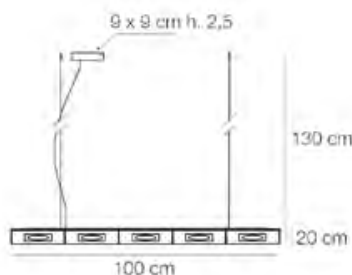



Suspension
 GX53 5x7W + LED 6 W
 Lampadina non inclusa
 Bulb not included

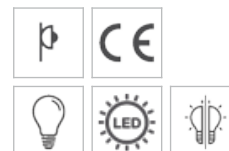
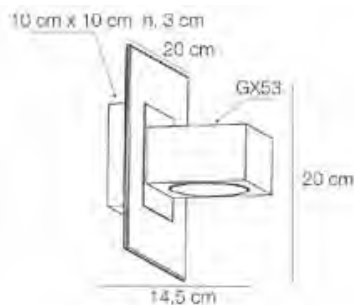

04011

Wall lamp
 GX53 2x7W + LED 1,2 W
 Lampadina non inclusa
 Bulb non included



Structure	Dimmer	Led Light	Lens	IP	Diffuser
AC  BB 	X (No Dimmer)	B  W 3000 K 	X (No lens)	X (IP20)	ST  TR 

Dado

Designer: Elesi Creative Lab

“La semplicità si veste di luce”
“Simplicity dressed in light”



DESIGN Dado è una collezione di applique compatte, elettrificate con attacco GX53. La sua forma geometrica consente di creare combinazioni a parete, giochi di forme che diventano parte dell'arredo nel quale sono inserite.

DESIGN Dado is a collection of compact wall lights, electrified with GX53 fitting. Its geometric shape offers plenty of scope for different combinations, playing on changing shapes and forms that become part of the furnishing scheme.



PERSONALITÀ E' compatta, semplice e lineare senza essere banale. Pura forma, la si sintonizza con i diversi stili di arredamento, esaltandone lo spazio e creando con la luce suggestivi effetti di chiaro/scuro.

PERSONALITY Compact, simple and linear without being banal. Its pure form blends in with different furnishing styles, highlighting the space and creating striking chiaroscuro lighting effects.



MAESTRIA La cura nel dettaglio trova la massima espressione nella spazzolatura del metallo, lavorazione di finitura eseguita completamente a mano. Quell'artigianalità che conferisce unicità a ciascuna lampada

EXPERTISE Attention to detail reaches a high point in the metal brushing, a finishing process carried out completely by hand. An artisan touch that makes each light unique.







Art 04101 OS



Art 04102 AC



Art 04102 OS



Art 04104 NR



Art 04107 BB



Art 04107 BB



Art 04106 HT



Art 04106 BB

04101

Wall lamp
GX53 1x7 W
Lampadina non inclusa
Bulb not included

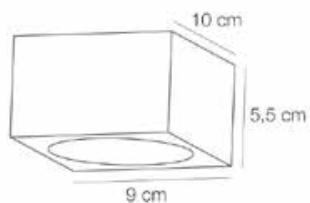

04102

Wall lamp
GX53 2x7 W
Lampadina non inclusa
Bulb not included

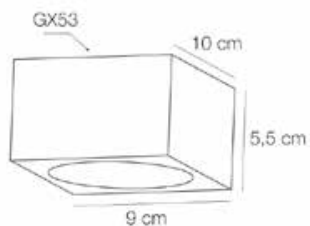

04104



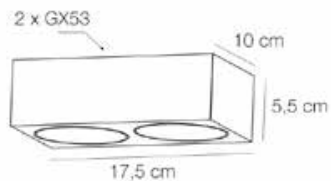

Wall lamp
GX53 4x7 W
Lampadina non inclusa
Bulb not included

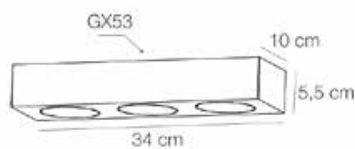

04107

Wall lamp
GX53 4x7 W
Lampadina non inclusa
Bulb not included





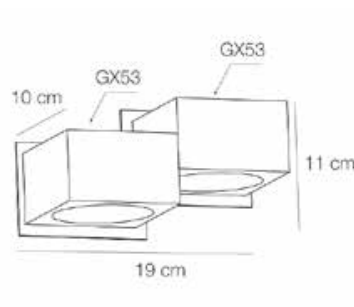

Structure	Dimmer	Led Light	Lens	IP	Diffuser
AC 	X (No Dimmer)	X	X (No lens)	X (IP20)	XX
BB 					
HT 					
NR 					
OS 					

04106

Wall lamp
 GX53 4x7 W
 Lampadina non inclusa
 Bulb not included



Structure	Dimmer	Led Light	Lens	IP	Diffuser
AC 	X (No Dimmer)	X	X (No lens)	X (IP20)	XX
BB 					
HT 					
NR 					
OS 					

Kant

Designer: Maurizio Betteto

“Un puzzle dalle forme geometriche”
“A puzzle with geometric shapes”



DESIGN Soluzione in metallo e illuminazione con lampadine GX53, a vista. La struttura è modulare. Il sistema ad attacco magnetico della struttura ne facilita l'installazione.

DESIGN Metal structure with visible GX53 bulbs. The structure is modular with magnetic fitting system for easy installation.



PERSONALITÀ La collezione Kant si contraddistingue per la modularità delle lampade che consente di illuminare grandi ambienti con un unico punto luce. Funzionale e pratica, dal design lineare, non banale, ricorda un puzzle dalle forme geometriche.

PERSONALITY The Kant collection is characterized by modularity, allowing the illumination of large areas with one single light point. Functional and practical, with an original linear design, it is reminiscent of a puzzle with geometric shapes.



MAESTRIA Ogni lampada è realizzata all'interno del nostro laboratorio creativo, dove l'artigianalità si sposa con la creatività e l'innovazione per eseguire prodotti unici.

EXPERTISE Each light is made in our workshop, where craftsmanship combines with creativity and innovation, resulting in unique products.





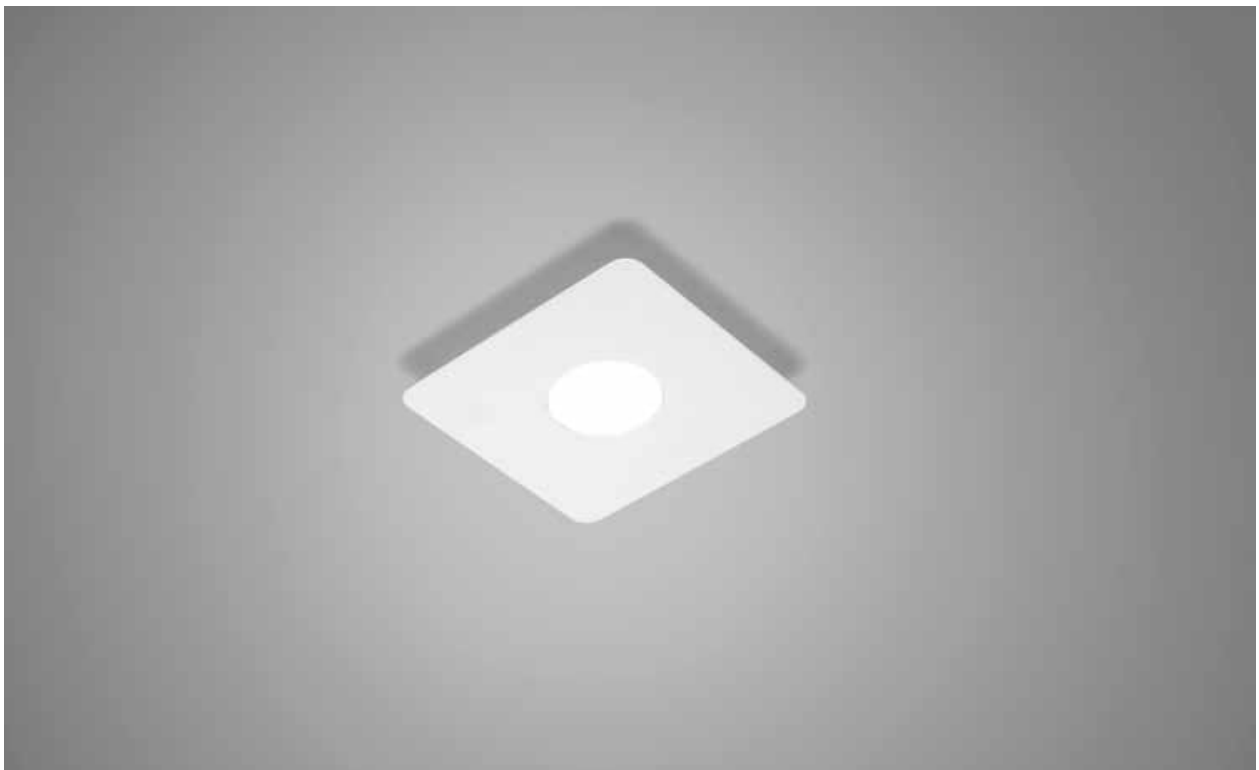

Art 03901 BB

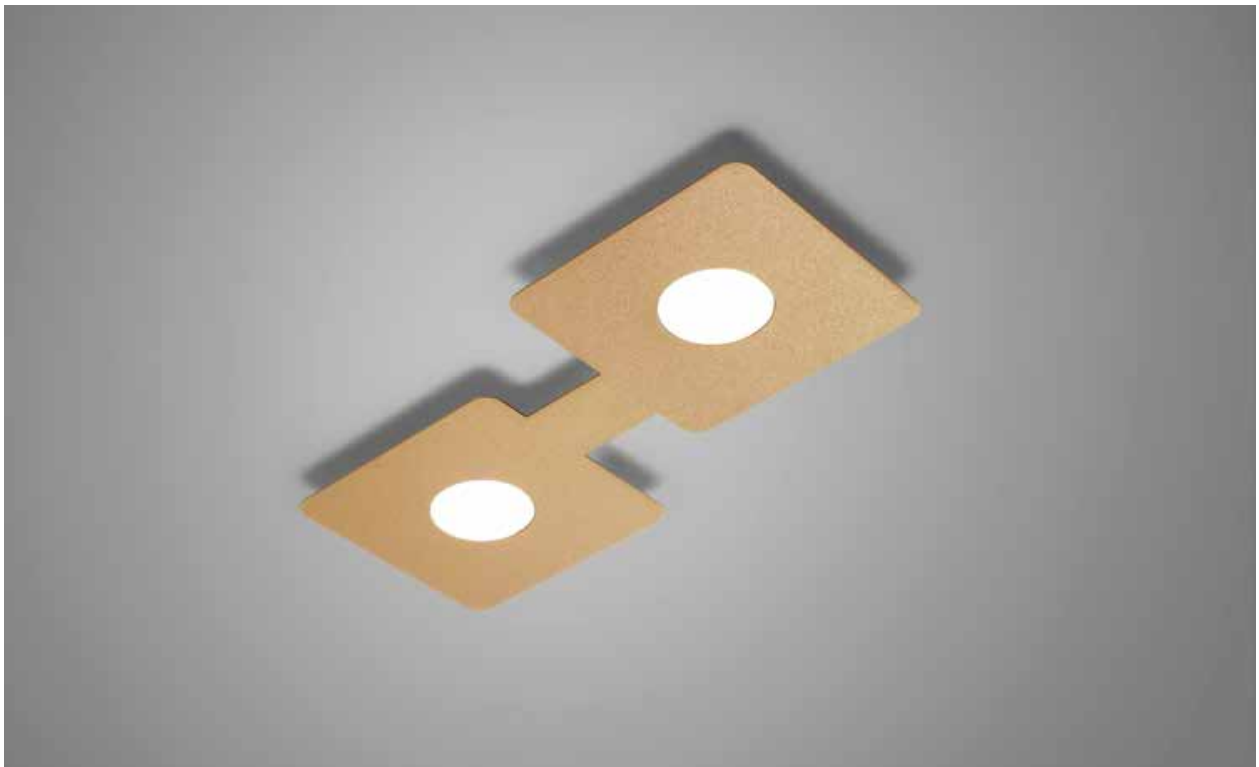

Art 03902 VO



Art 03902 VO

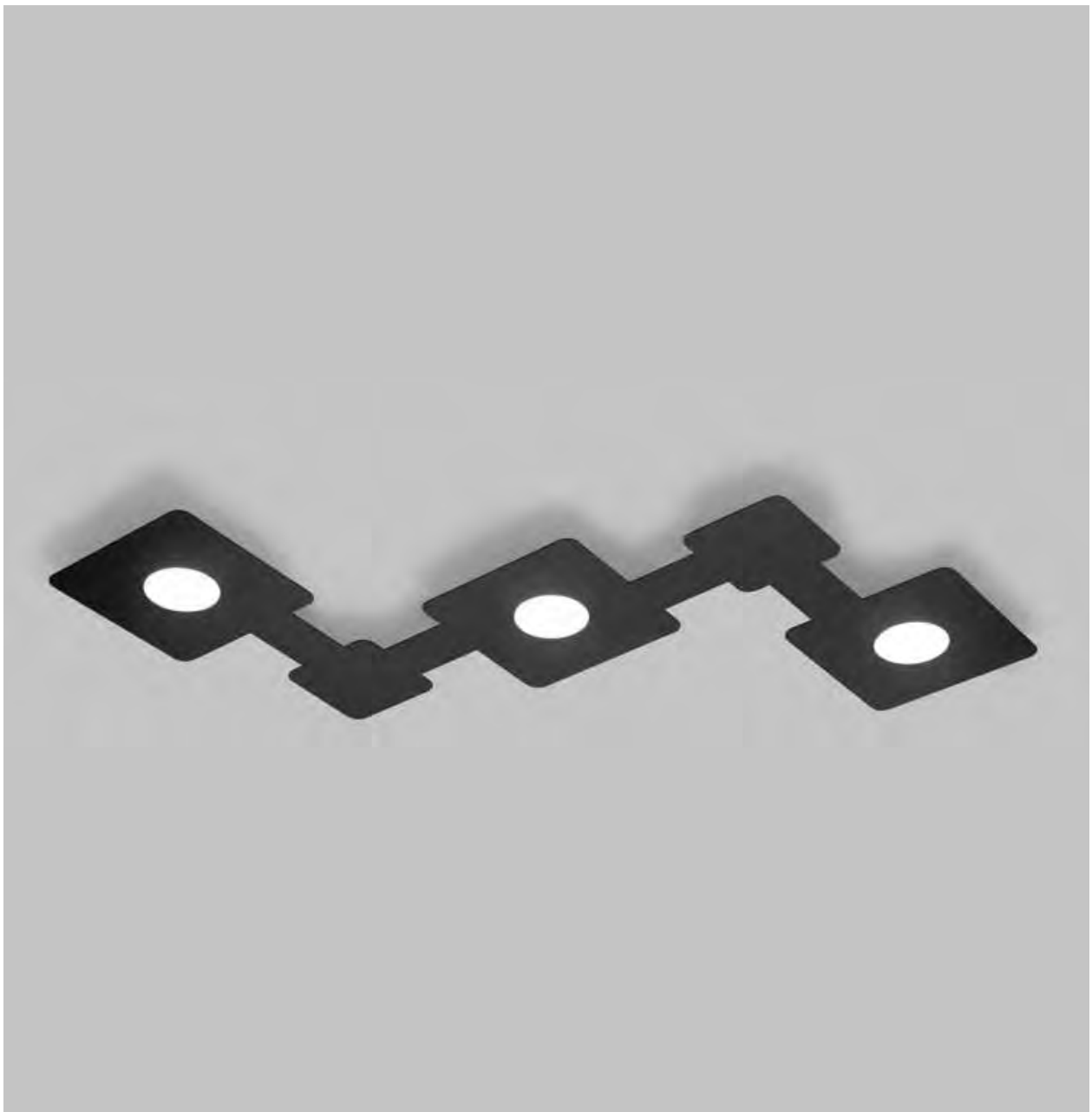

Art 03903 NR



Art 03905 VO



Art 03904 BB

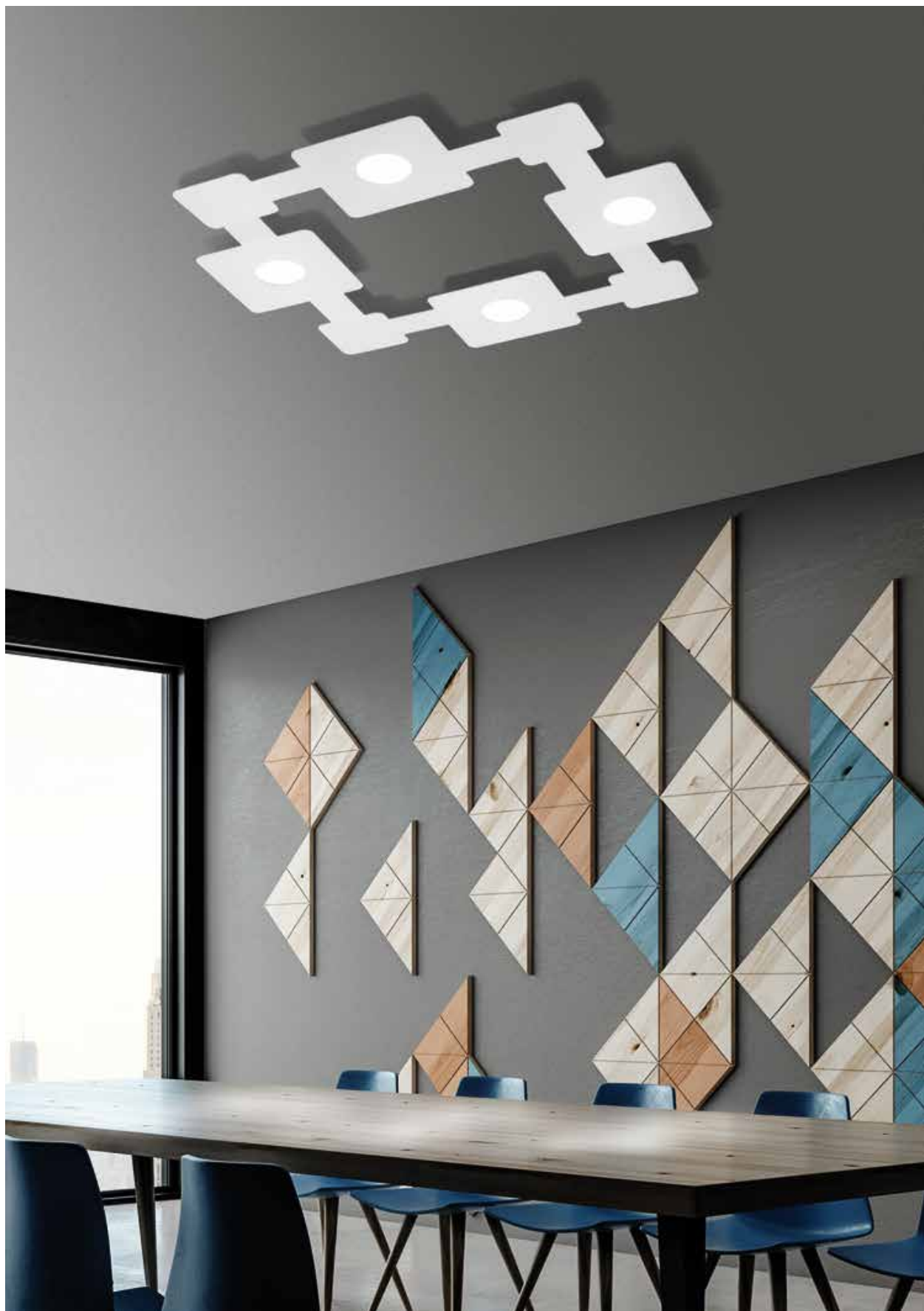

Art 03904 BB

03901

Ceiling lamp
GX53 1x7 W
Lampadina non inclusa
Bulb not included

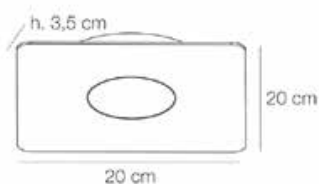

03902

Ceiling lamp
GX53 2x7 W
Lampadina non inclusa
Bulb not included

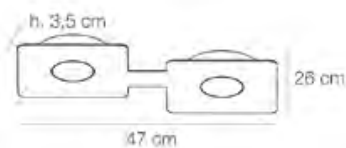

03903

Ceiling lamp
GX53 3x7 W
Lampadina non inclusa
Bulb not included

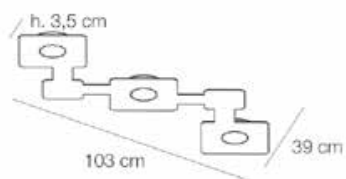

03904

Ceiling lamp
GX53 4x7 W
Lampadina non inclusa
Bulb not included

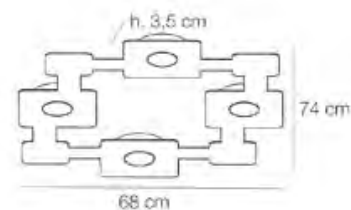

Structure	Dimmer	Led Light	Lens	IP	Diffuser
BB <input type="checkbox"/>	X (No Dimmer)	X	X (No lens)	X (IP20)	XX
NR <input type="checkbox"/>					
VO <input type="checkbox"/>					

03905

Ceiling lamp
 GX53 6x7 W
 Lampadina non inclusa
 Bulb not included



Structure	Dimmer	Led Light	Lens	IP	Diffuser
BB <input type="checkbox"/>	X (No Dimmer)	X	X (No lens)	X (IP20)	XX
NR <input type="checkbox"/>					
VO <input type="checkbox"/>					

Storie di accordi

Stories of chords

*“Io vedo la musica come
fluida architettura.”*

(Joni Mitchell - Cantautrice)

*“I see music as
fluid architecture.”*

(Joni Mitchel - Singer/Song writer)



In musica l'Accordo è la simultaneità di più suoni aventi un'altezza definita, è lo stare insieme in armonia. In generale è una raccolta di singoli elementi, che messi assieme sapientemente creano una sinfonia sia essa di note, di forme, di colori o di luce. Storie di Accordi narra di un sistema che si compone di molti elementi, ciascuno dei quali svolge una determinata funzione, e che combinati assieme si traducono in soluzioni illuminotecniche distintive e uniche.

In music a chord is a group of notes sounded together, as a basis of harmony. In general it is a collection of single elements which, when artfully combined, create a symphony of notes, forms, colours or light. Stories of Chords describes a system composed of many elements, each performing a given function and which, when combined together, translate into distinctive and unique lighting solutions.



E-Viva

Designer: Maurizio Betteto

“Un sistema modulare unico”
“A unique modular system”



DESIGN E-Viva è un sistema LED monotubo modulare dal design minimal per creare soluzioni illuminotecniche personalizzate. Il tubo elettrificato, di un diametro di appena 6 mm, è componibile e per questo estremamente adattabile alle diverse esigenze.

DESIGN E-viva is a modular single-tube LED system featuring a minimalist design to create customized lighting solutions. The electrified tube, with diameter of just 6 mm, is modular and therefore extremely adaptable to different needs.



PERSONALITÀ E-viva illumina gli ambienti esaltando il tuo stile grazie ai suoi elementi modulari che permettono di realizzare soluzioni personalizzate, alle sorgenti di luce orientabili che mettono in evidenza gli oggetti sui quali si posano.

PERSONALITY E-viva lighting enhances your style thanks to its modular elements that can be used to create customized solutions and the adjustable light sources that highlight individual objects.



MAESTRIA E-Viva è un sistema a led integrati brevettato da Elesi Luce. La cura nel dettaglio trova la massima espressione nella spazzolatura del metallo, lavorazione di finitura eseguita completamente a mano.

EXPERTISE E-Viva is an integrated LED system patented by Elesi Luce. Attention to detail reaches a high point in the metal brushing, a finishing process carried out 100% by hand.











Art 10001 OF / Art 10017 OF



Art 14700 AC



Art 14700 OF

Sistema in 3 passaggi / System in 3 steps

Partendo dal punto di alimentazione traccia il percorso del sistema.
Starting from the power supply draw the path of your system.



Scegli / Choose

- A) Tubi Elettrificati / *Electrified Tubes*
- B) Elementi di Giunzione / *Junction Elements*
- C) Supporti / *Fixing Elements*

1TB01

Tubo Elettrificato
Electrified Tubes



1TB02

Tubo Elettrificato
Electrified Tubes

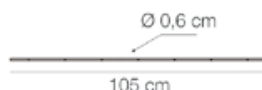

1TB03

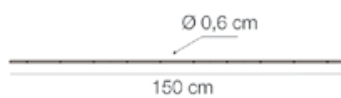

Tubo Elettrificato
Electrified Tubes

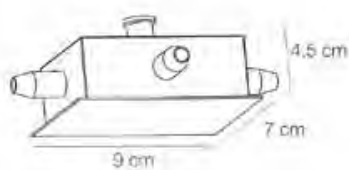

1CP07

Elementi di Giunzione
Junction Element



Structure	Dimmer	Led Light	Lens	IP	Diffuser
AC 	X	X	X	X	XX
OF 					

1CP01

Elementi di Giunzione
Junction Element

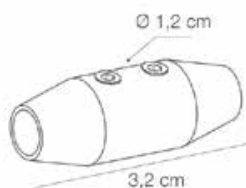

1CP02

Elementi di Giunzione
Junction Element

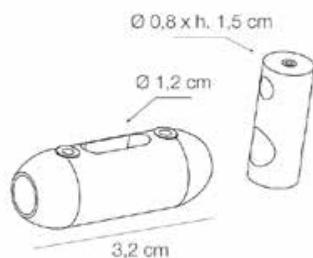

1FX01

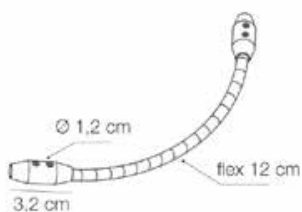

Elementi di Giunzione
Junction Element

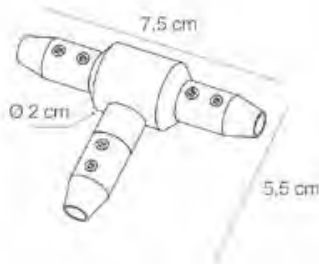

1CP06

Elementi di Giunzione
Junction Element



Structure	Dimmer	Led Light	Lens	IP	Diffuser
AC 	X	X	X	X	XX
OF 					

1SU01

Supporto per parete o soffitto
Fixing Element

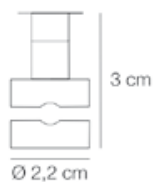

1SU02

Supporto per parete o soffitto
Fixing Element

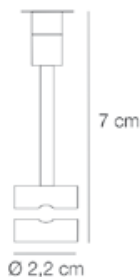

1SU03

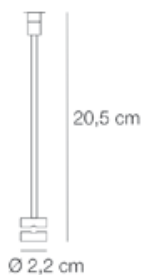

Supporto per parete o soffitto
Fixing Element



1SU04

Supporto per parete o soffitto
Fixing Element



Structure	Dimmer	Led Light	Lens	IP	Diffuser
AC 	X	X	X	X	XX
OF 					

Sistema in 3 passaggi / System in 3 steps

Individuare le zone da illuminare quindi scegliere le sorgenti.
Identify the area to be lit and choose the light sources.



Scegli / Choose

Sorgenti LED / LED Sources

10017

Sorgente Led
 Led Source
 Lens 42° on request 25°

6 W
 880 lm



10001

Sorgente Led
 Led Source
 Lens 25°

3 W
 370 lm





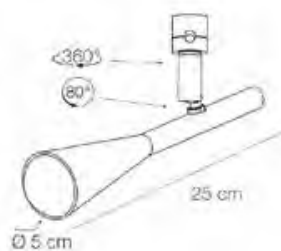

14700

Sorgente Led
 Led Source

6,7 W
 900 lm



Structure	Dimmer	Led Light	Lens	IP	Diffuser
AC  OF 	X	W 3000 K  N 4000 K 	X	X	XX

Sistema in 3 passaggi / System in 3 steps

Definisci il collegamento elettrico.
Statement of electrical connection.

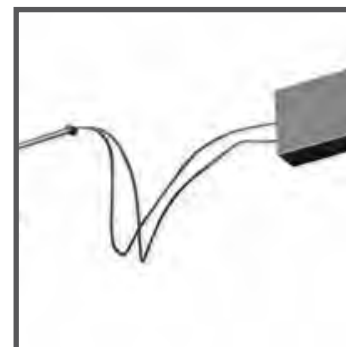

Cavo / Cable

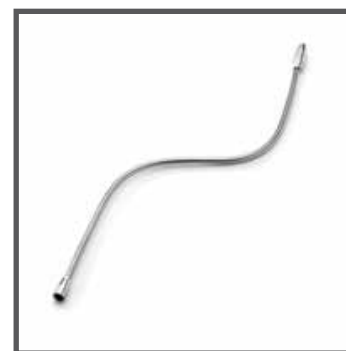

Tubo Flex / Flex Tube

Scegli / Choose

- A) Collegamento al sistema / System connection
- B) Alimentatore / Power supply
- C) Scatola alimentatore (Opzionale) / Power supply box (Optional)

1FX02

Collegamento laterale al sistema

Lateral power supply connector

Flex 20 cm

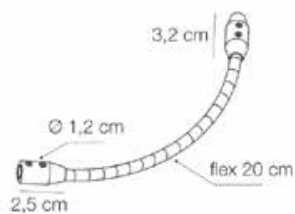

1FX03

Collegamento laterale al sistema

Lateral power supply connector

Flex 40 cm

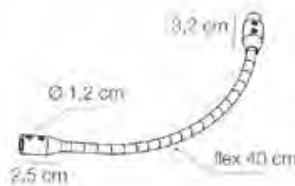



1FX04

Collegamento laterale al sistema

Lateral power supply connector

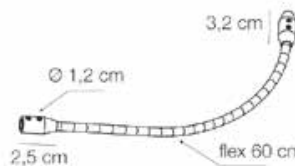
Flex 60 cm



Structure	Dimmer	Led Light	Lens	IP	Diffuser
AC 	X	X	X	X	XX
OF 					

1FX05

Collegamento centrale al sistema

Central power supply connector

Flex 20 cm

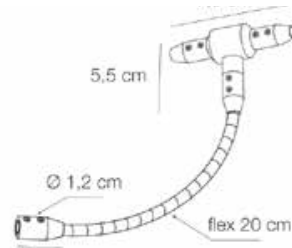

1FX06

Collegamento centrale al sistema

Central power supply connector

Flex 40 cm

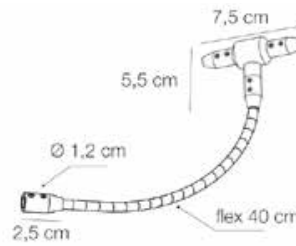



1FX07

Collegamento centrale al sistema

Central power supply connector

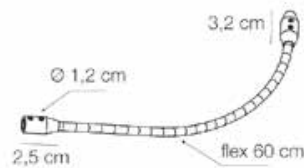
Flex 60 cm



Structure	Dimmer	Led Light	Lens	IP	Diffuser
AC 	X	X	X	X	XX
OF 					

1DR01

Alimentatore
Power Supply
 35 W

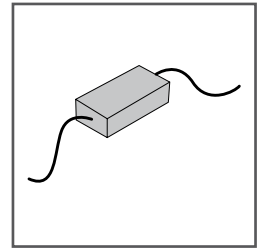

1BX01

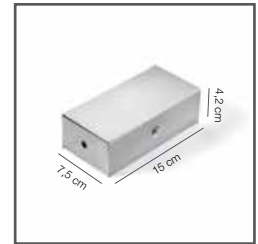

Scatola per alimentatore con 1 foro
Power Supply Box with 1 hole

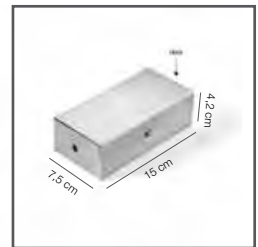

1BX02

Scatola per alimentatore con 2 fori
Power Supply Box with 2 holes



Structure	Dimmer	Led Light	Lens	IP	Diffuser
AC 	X	X	X	X	XX
OF 					

1DR02

Alimentatore
Power Supply
 60 W

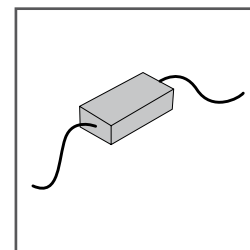

1BX03

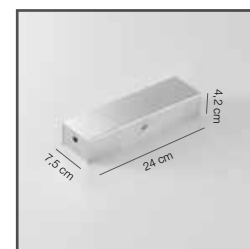

Scatola per alimentatore con 1 foro
Power Supply Box with 1 hole



1BX04

Scatola per alimentatore con 2 fori
Power Supply Box with 2 holes



Structure	Dimmer	Led Light	Lens	IP	Diffuser
AC 	X	X	X	X	XX
OF 					

1DR03

Alimentatore
Power Supply
 100 W

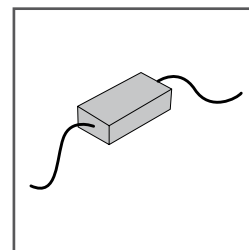

1BX05

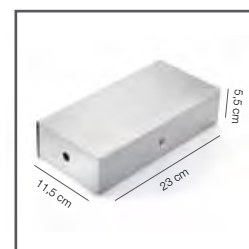

Scatola per alimentatore con 1 foro
Power Supply Box with 1 hole

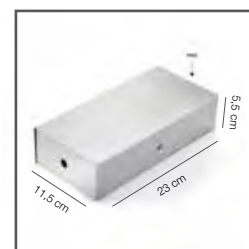

1BX06

Scatola per alimentatore con 2 fori
Power Supply Box with 2 holes



Structure	Dimmer	Led Light	Lens	IP	Diffuser
AC 	X	X	X	X	XX
OF 					





Creative Direction: Fondo Plastico di Federica Preto
Graphic Designer: Simone Guerretta
Photography: Studio Pointer, Fisheye comunicazione, Link
Render: Mind@ware

Print: Logo srl

Questo prodotto è composto da materiale
che proviene da foreste ben gestite certificate FSC®,
da materiali riciclati e da altre fonti controllate.
Il catalogo è stampato con inchiostri a base vegetale.

*This product is composed by material coming from FSC®
certified well managed forests, recycled materials
and other controlled sources.
The catalog is printed with plant-based inks.*

I dati riportati in questo catalogo sono indicativi e non costituiscono impegno da parte di Elesi Luce srl che si riserva il diritto di apportare tutte le modifiche e migliorie necessarie senza obbligo di preavviso. Il presente catalogo ha durata pluriennale, i dati tecnici possono subire cambiamenti che verranno aggiornati sul sito www.elesiluce.it.

All data in this catalog are generic and do not constitute a commitment on the part of Elesi Luce srl which reserves the right to make all necessary changes and improvements without prior notice. This catalog will last of several years, the technical data may undergo changes which will be updated on the website www.elesiluce.it.

Elesi Luce ringrazia i docenti e gli studenti/studentesse delle scuole:

Elesi Luce thanks the teachers and students of the schools:

Enaip di Dolo

Istituto Rosselli di Castelfranco Veneto

Istituto Salesiano San Marco

Liceo Artistico Catullo di Belluno

Liceo Artistico Munari di Vittorio Veneto per partecipazione al concorso finalizzato alla creazione della copertina del catalogo.

For participation in the competition aimed at creating the cover of the catalog.

Sono stati selezionati i seguenti progetti:

The following projects were selected:

Copertina / Coverbook di Giulia Contin (Liceo Artistico Munari)

Pag. 1 di Davide Bianco (Istituto Salesiano San Marco)

Pag. 6 di Emma Zambon ed Elena Bastistuzzi (Liceo Artistico Munari).

Tutti i progetti sono consultabili qui:

You can find all projects here:



Elesi Luce®

Via Magellano, 8 - 35010
Trebaseleghe (PD) / Italy

info@elesiluce.it

t. +39 049 9385235

www.elesiluce.it

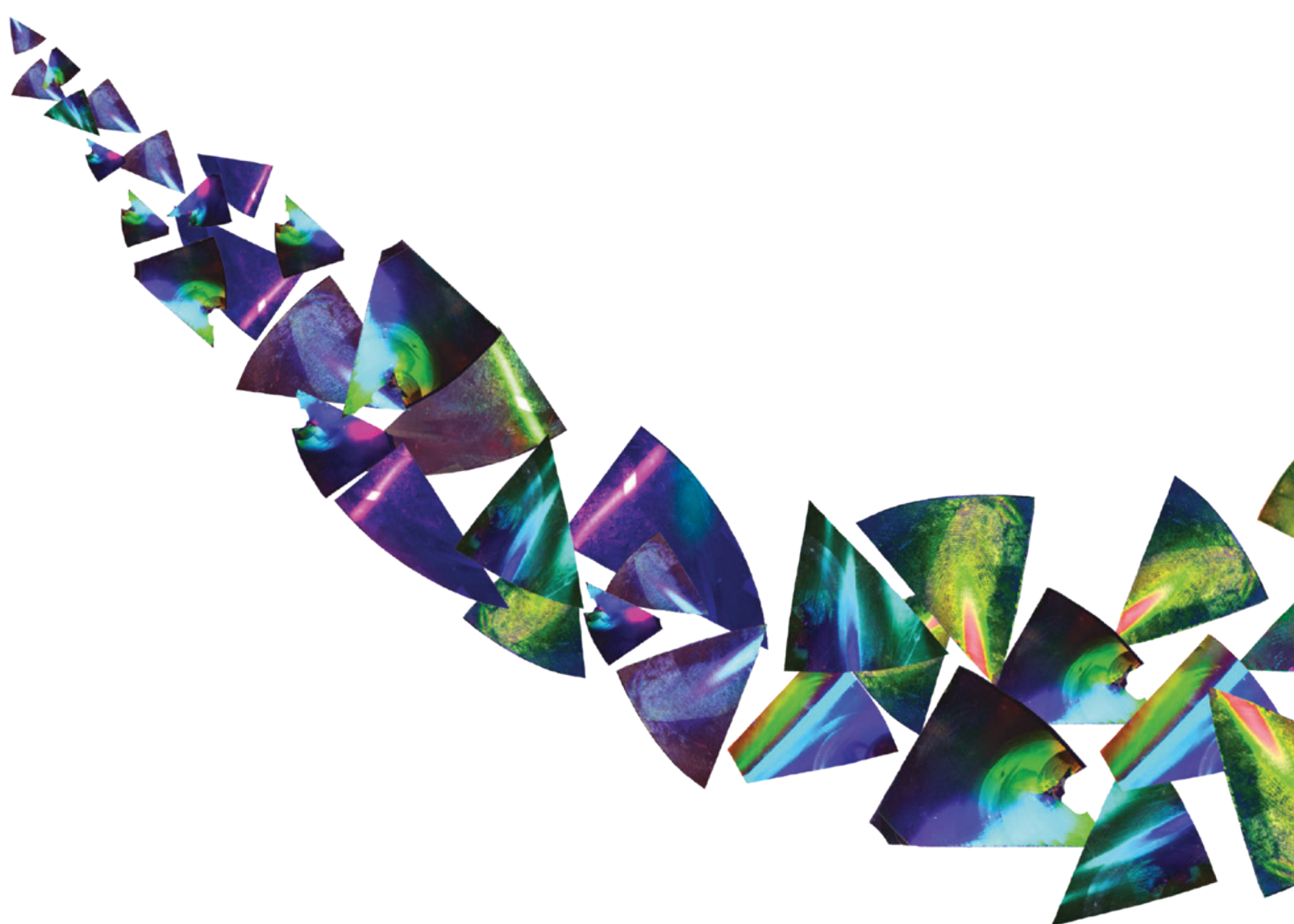

www.elesiluce.it